

**US-550/US-160**

**FINAL Connection Design Build  
Lane Closure Strategy Report**

Prepared for:  
Colorado Department of Transportation

January 10, 2019

DN18-0569.03

FEHR  PEERS



## Table of Contents

<b>1.0</b>	<b>EXECUTIVE SUMMARY</b> .....	<b>2</b>
<b>2.0</b>	<b>INTRODUCTION</b> .....	<b>3</b>
<b>3.0</b>	<b>METHODOLOGY</b> .....	<b>7</b>
3.1	Level of service.....	7
3.2	Mobility Thresholds.....	9
<b>4.0</b>	<b>DATA COLLECTION</b> .....	<b>10</b>
<b>5.0</b>	<b>EXISTING CONDITIONS</b> .....	<b>11</b>
5.1	Peak Hour Intersection Turning Volumes.....	11
5.2	Peak Hour intersection LOS.....	11
5.3	Daily Traffic Volume Peaking characteristics.....	16
<b>6.0</b>	<b>MAINTENANCE OF TRAFFIC ANALYSIS</b> .....	<b>19</b>
6.1	Introduction.....	19
6.2	Anticipated construction Phasing.....	19
6.3	Traffic Analysis.....	25
<b>7.0</b>	<b>OPTIONAL APPROACHES</b> .....	<b>43</b>
<b>8.0</b>	<b>RECOMMENDATIONS</b> .....	<b>45</b>

CONFIDENTIAL

## 1.0 EXECUTIVE SUMMARY

CDOT is preparing to complete the US-550 / US-160 connection project through a design-build procurement method. The project will construct a four-mile section of US-550 from CR-302 to US-160 as shown in **Figure 2.1** through **2.3**. US-550 is currently a 2-lane highway in this area. It will be reconstructed as a 4-lane divided highway. The intersections at US-160 / US-550 and US-550 / CR-220 will also be reconfigured with this project.

This report was prepared to evaluate a potential construction phasing sequence and its impacts on mobility. Mobility Thresholds were identified to determine if a lane closure would be acceptable or not. For the purpose of this project, it was assumed that the following mobility thresholds were used:

- Level of Service (LOS) was assumed to be maintained at LOS D or better for the overall intersection and LOS E or better for individual approaches at impacted intersections during peak hours
- Travel Time impacts for out-of-direction travel was assumed to be less than 20 minutes.
- Queues were assumed to be maintained within existing storage.

Table 1.1 outlines the recommended allowed closures for this project.

**Table 1.1: Recommended Allowed Closures**

Closure	Allowed?
Long-Term Full Closure of Ramp B	Yes
Long-Term WB Lane Closure on US-160	No
Long-Term EB Lane Closure on US-160	No
Long-Term Full Closure on US-550	No
Long-Term Full Closure on CR-220	No
One-Lane Two-Way Operations on US-550	Yes <sup>1</sup>
Off-Peak Lane Closures (7 PM to 7 AM)	Yes

1. This lane restriction is allowed for distances of 2000' or less.

Language should also be included to mandate monitoring of traffic during construction.

## 2.0 INTRODUCTION

CDOT is preparing to complete the US-550 / US-160 connection project through a design-build procurement method. This Lane Closure Strategy Report evaluates the traffic constraints of lane closures at this location as well as identifies innovative strategies for construction phasing. This report will help CDOT determine appropriate lane closure restrictions to implement as part of the US-550 / US-160 Connection Design Build project.

The project will construct a four-mile section of US-550 from CR-302 to US-160 as shown in **Figure 2.1**. US-550 is currently a 2-lane highway in this area. It will be reconstructed as a 4-lane divided highway. The intersection at US-160/US-550 will also be relocated from its existing location and will connect with the Wilson Gulch interchange. A new roundabout intersection will be constructed south of US-160 at the interchange to accommodate this reconfiguration as shown in **Figure 2.2**. The intersection at US-550/CR-220 will also be realigned from a skewed "triangle" intersection to a more traditional intersection that is better aligned with US-550 as shown in **Figure 2.3**.

This report also proposes a concept for major construction traffic phases that is intended to establish a baseline concept for construction phasing. The proposers would be required to either comply with this overall approach, or recommend Alternative Technical Concepts (ATCs) that are equal to or better than the concept presented here-in. An evaluation of the impacts of the proposed closure strategy is also provided. The proposers would be required to meet or exceed the same thresholds identified in the analysis presented for approval of ATCs. It is recommended that mobility thresholds for the project be established to evaluate if ATCs are acceptable. For the purposes of this analysis, it was assumed that the following three mobility thresholds were in place:

- Travel Time: No detour would result in more than 20 minutes of out-of-direction travel
- Level of Service (LOS): All intersections would operate at LOS D or better for the overall intersection, and LOS E or better for individual approaches
- Queueing: All queues would fit within available storage

### Glossary

Short-Term Closure: Any lane or roadway closure that is limited to off-peak periods.

Long-Term Closure: Any lane or roadway closure that is allowed during peak periods.

Alternative Technical Concept (ATC): Concepts developed by the proposer that are determined by the owner to be equal to or better than the original concept, and therefore allowed within the proposers bid.





# PROJECT OVERVIEW

Figure 2.1



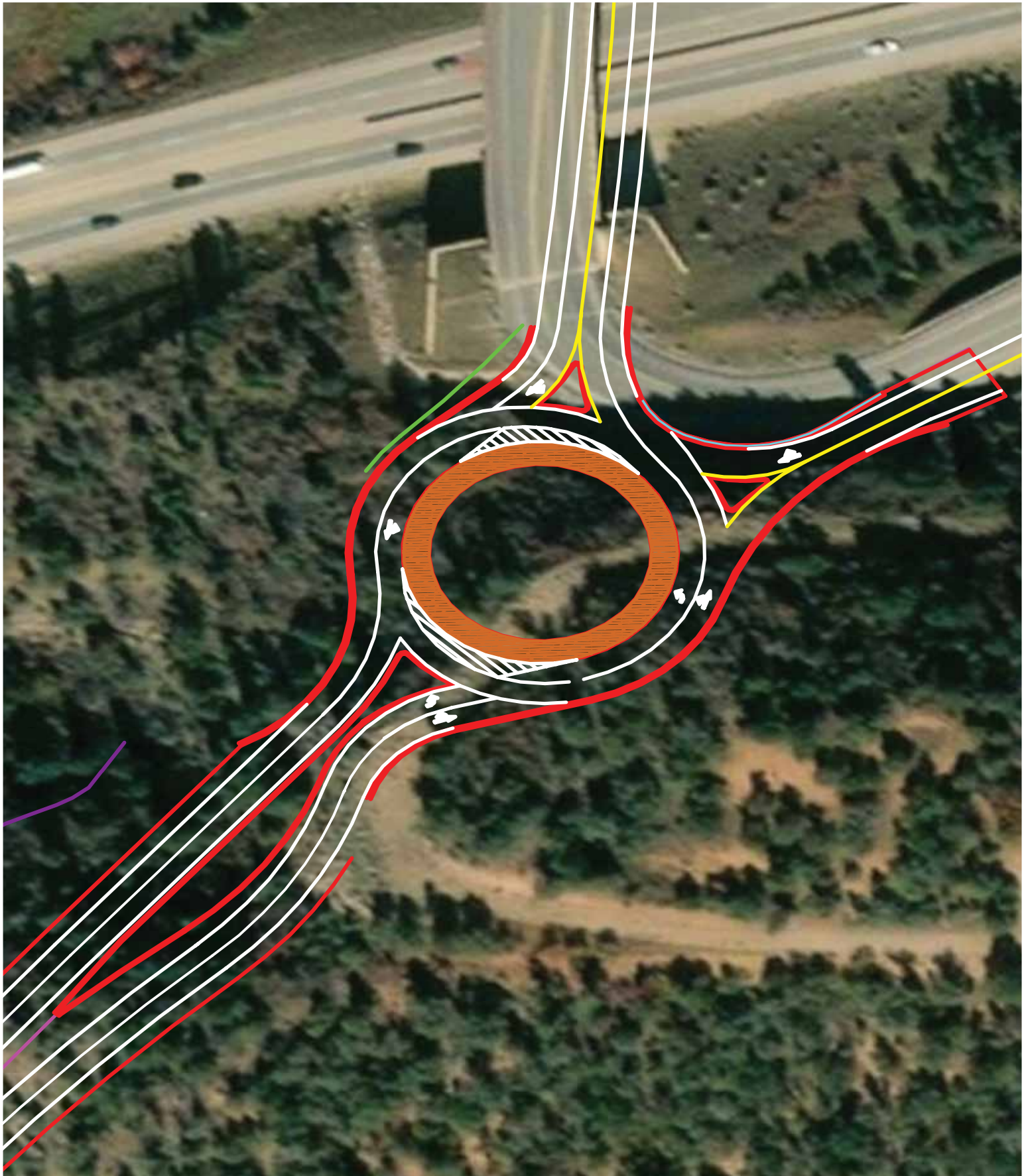

← AUBURN

# US-160 / US-550 INTERCHANGE

Figure 2.2



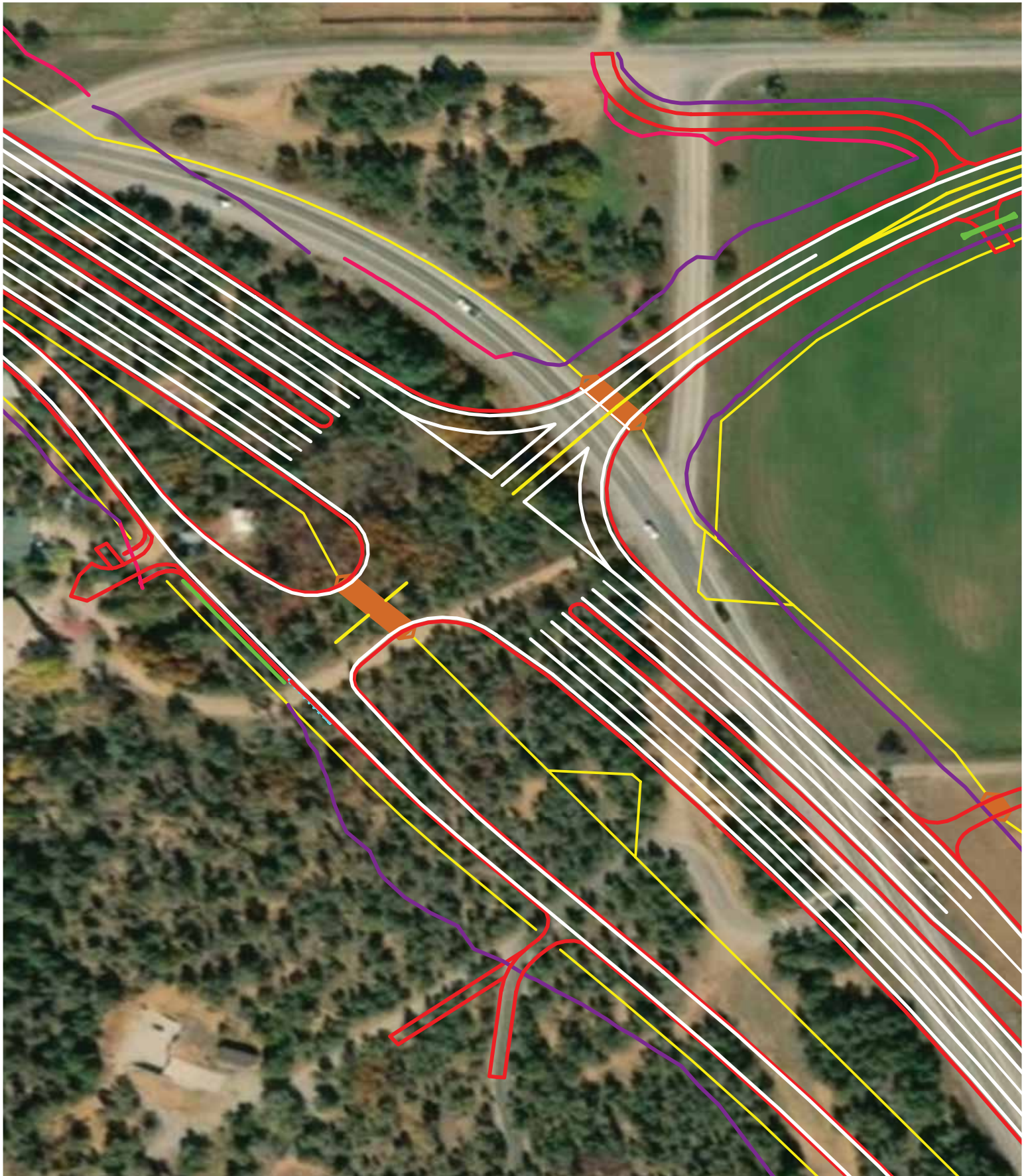

← NORTH

# US-550 / CR-220 INTERSECTION

Figure 2.3

## 3.0 METHODOLOGY

The transportation operations analysis addressed signalized and unsignalized intersection operations using the procedures and methodologies contained in the Highway Capacity Manual 2010 (HCM), Transportation Research Board for the weekday AM and PM peak hour traffic operations. Study intersection operations were evaluated using level-of-service calculations as analyzed in the Synchro software (Version 09).

### 3.1 LEVEL OF SERVICE

To measure and describe the operational status of the local roadway network and corresponding intersections, transportation engineers and planners commonly use a grading system called level-of-service (LOS) put forth by the Transportation Research Board's HCM 2010. LOS characterizes the operational conditions of an intersection's traffic flow; ranging from LOS A (indicating free flow traffic conditions with little or no delay) to LOS F (representing over-saturated conditions where traffic flows exceeds the design capacity, resulting in long queues and delays). These grades represent the perspective of drivers and are an indication of the comfort and convenience associated with driving. Although LOS A through C are desired levels, LOS D is considered acceptable. Traffic conditions with LOS E or F are generally considered unacceptable and represent significant travel delay, increased accident potential, and inefficient motor vehicle operation. The LOS is determined differently depending on the type of control at the intersection.

At signalized intersections, the operation analysis uses various intersection characteristics (such as traffic volumes, lane geometry, and signal phasing) to estimate the intersection's volume-to-capacity (v/c) ratio. For signalized intersections the HCM defines the intersection LOS as the average delay per vehicle for the overall intersection, which includes all approaches.

At unsignalized intersections, the operations analysis uses various intersection characteristics (such as traffic volumes, lane geometry, and stop-controlled approaches) to estimate the intersection's volume-to-capacity (v/c) ratio. For unsignalized intersections the HCM defines the intersection LOS as either the average delay per vehicle for the worst approach or the whole intersection for side-street stop and all-way stop intersections, respectively. **Table 3.1** summarizes the relationship between delay and LOS for signalized intersections and **Table 3.2** summarizes the relationship between delay and LOS for unsignalized intersections and roundabouts.

**TABLE 3.1:  
SIGNALIZED INTERSECTION LEVEL OF SERVICE DEFINITIONS  
USING AVERAGE CONTROL VEHICULAR DELAY**

Level of Service	Description	Average Control Delay Per Vehicle (Seconds)
A	Operations with very low delay occurring with favorable progression and/or short cycle lengths.	< 10.0
B	Operations with low delay occurring with good progression and/or short cycle lengths.	> 10 to 20
C	Operations with average delays resulting from fair progression and/or longer cycle lengths. Individual cycle failures begin to appear.	> 20 to 35
D	Operations with longer delays due to a combination of unfavorable progression, long cycle lengths, and high V/C ratios. Many vehicles stop and individual cycle failures are noticeable.	> 35 to 55
E	Operations with high delay values indicating poor progression, long cycle lengths, and high V/C ratios. Individual cycle failures are frequent occurrences.	> 55 to 80
F	Operations with delays unacceptable to most drivers occurring due to over-saturation, poor progression, or very long cycle lengths.	> 80

Source: *Highway Capacity Manual (Transportation Research Board, 2010).*

**TABLE 3.2:  
UNSIGNALIZED INTERSECTION AND ROUNDABOUT LEVEL OF SERVICE DEFINITIONS  
USING AVERAGE CONTROL VEHICULAR DELAY**

Level of Service	Description	Average Control Delay Per Vehicle (Seconds)
A	Little or no delay.	<10
B	Short traffic delay.	> 10 to 15
C	Average traffic delays.	> 15 to 25
D	Long traffic delays.	>25 to 35
E	Very long traffic delays.	>35 to 50
F	Extreme traffic delays with intersection capacity exceeded.	>50

Source: *Highway Capacity Manual (Transportation Research Board, 2010).*



## 3.2 MOBILITY THRESHOLDS

Within the study area, CDOT uses LOS D or better as the acceptable LOS for both intersections and highway segments. Metrics that can be used to evaluate construction activities on mobility may include:

- Changes in LOS
- Changes in Travel Time
- Changes in Queue Lengths

### 3.2.1 LEVEL OF SERVICE

LOS is effective at assessing mobility impacts during construction as it is a commonly used metric that assess the traveler's experience. A weakness of this metric is that LOS is usually only defined for peak hour operations and does not capture the impacts of off-peak construction activities well. There are a variety of potential thresholds that could be implemented for this project such as:

- Maintain traffic conditions equal to or better than the existing LOS, or
- Allow impacts to LOS that don't exceed LOS D conditions, or
- Allow an increase in intersection delay up to 30%, but not to exceed LOS E conditions.

Further discussion with the project team and CDOT stakeholders should be completed to identify acceptable thresholds for LOS during construction. For this project, it is recommended that a lane closure would be acceptable as long as it didn't result in an intersection exceeding LOS D conditions overall or exceed LOS E for any individual approach during the peak hours.

### 3.2.2 TRAVEL TIME

Travel time is also a useful metric for measuring detour routes and out-of-direction travel. For the purposes of this evaluation, it is recommended that detour routes should not result in increases in travel time in excess of 20 minutes.

### 3.2.3 QUEUE LENGTHS

Queueing is also an important metric for evaluating traffic impacts during construction. Similar to LOS, this is often only evaluated for peak-hour impacts. This metric also relates to safety in the work-zone as increasing queues beyond available storage can result in queues spilling back into and blocking mainline traffic flow. For the purpose of this study, the allowed mobility threshold is that queues fit within available storage. If a queue is currently exceeding available storage, it was assumed that the construction activities should not increase the queue length without providing mitigations.

## 4.0 DATA COLLECTION

Twenty-four hour traffic volume counts were conducted for a one-week period at the following locations including classification data:

- US-160 west of the existing intersection at US-550
- US-160 east of the future US-550 interchange (west of CR-232)
- US-550 south of US-160
- CR-220 east of US-550

Peak hour traffic volume counts were conducted on a weekday at the following intersections:

- US-160/US-550
- US-550/CR-220
- Wilson Gulch Dr.

Data available from the following three adjacent Automatic Traffic Recorders (ATRs) were evaluated:

- ATR Station 000257 on SR-550 near the border with New Mexico
- ATR Station 000217 on US-160 near Bayfield
- ATR Station 104809, MP 83.2 on US-160 near Santa Rita Park

These counts were conducted on a weekday from middle to end of September, which is representative of "summer time" traffic conditions. An additional count was conducted on a weekday at the following intersection:

- SH 172/CR 220

This count was conducted in December and represents "winter time" traffic conditions. In order to complete the analysis presented in this report, winter counts were increased by a seasonal adjustment factor of 15% to convert them to summer. For winter analysis, the summer counts were reduced by 15% to convert them to winter. All traffic counts are available in **Appendix A**.

## 5.0 EXISTING CONDITIONS

Existing conditions within the study area were evaluated based on the following three features:

- Peak hour intersection turning volumes
- Peak hour intersection LOS
- Daily Traffic Volume Peaking characteristics

### 5.1 PEAK HOUR INTERSECTION TURNING VOLUMES

**Figure 5.1** and **Figure 5.2** show the study intersections with summer and winter peak-hour traffic volumes.

### 5.2 PEAK HOUR INTERSECTION LOS

The existing operations of the study intersections were evaluated for the highest one-hour volumes during the weekday morning (AM Peak) and evening (PM peak) peak periods. The operations model included the existing roadways, intersection geometry, traffic control, and existing traffic. Analysis included assessing the intersection delay and LOS performance for each of the studied intersections.

According to the traffic volume counts, the AM Peak period is from 7:30 am to 8:30 am and the PM Peak period is from 4:30 pm to 5:30 pm. **Table 5.1** and **Table 5.2** provide the results of the capacity analysis of the Existing Conditions for the AM and PM peak hours assuming current geometry and traffic control. **Appendix B** provides the LOS reports for the Existing Conditions.



Source: path:

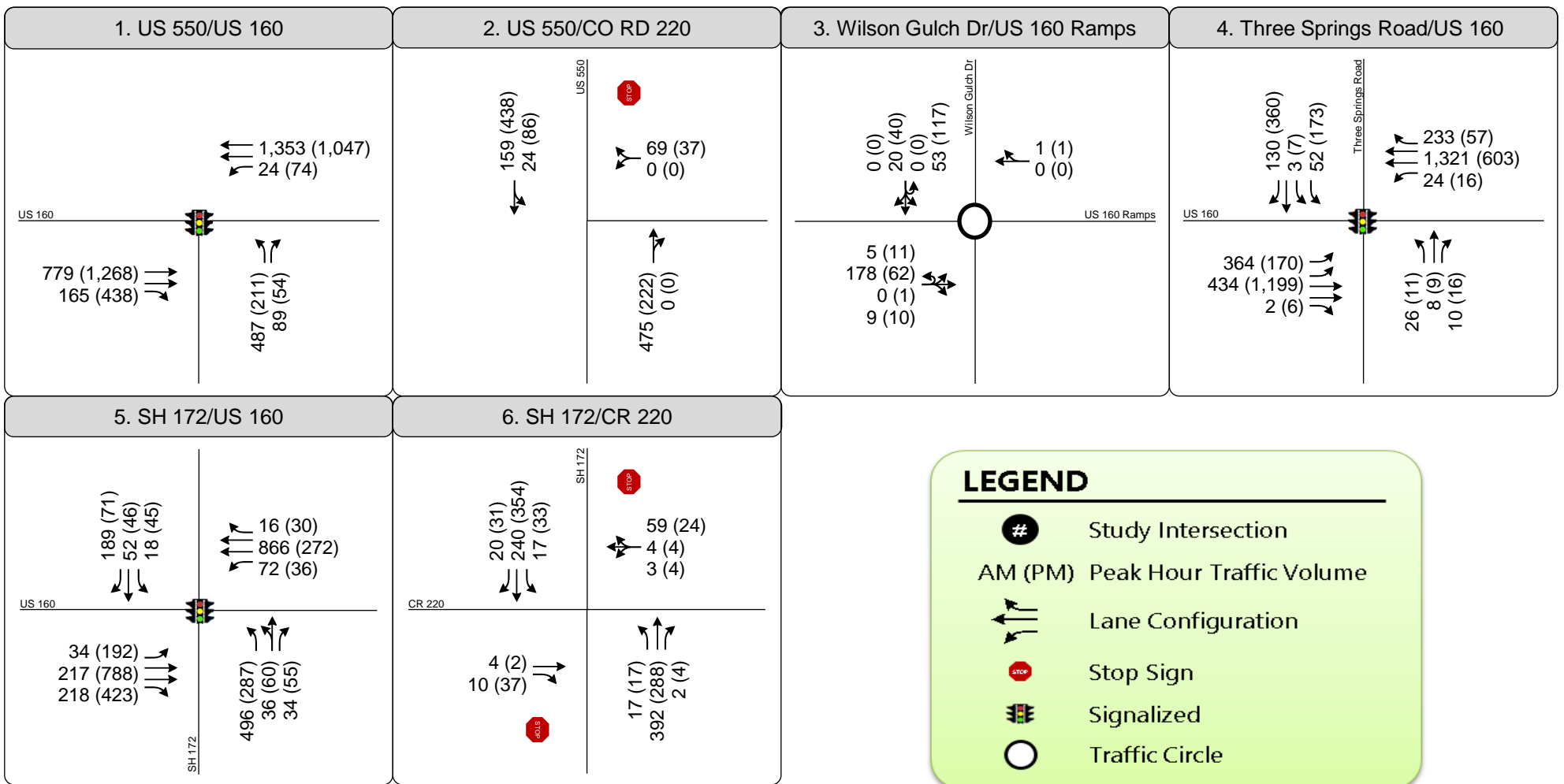
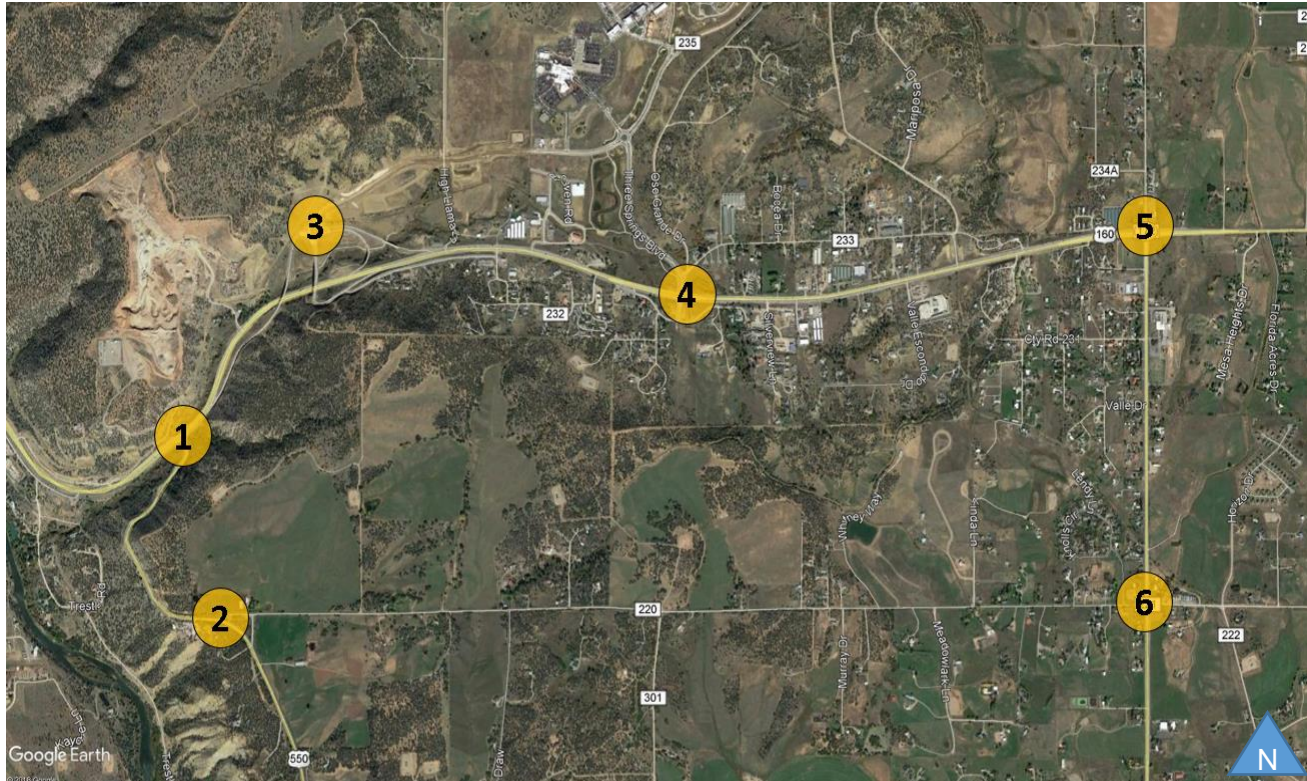

Figure 5.1  
Peak Hour Traffic Volumes  
and Lane Configurations  
Winter Counts





Source: path:

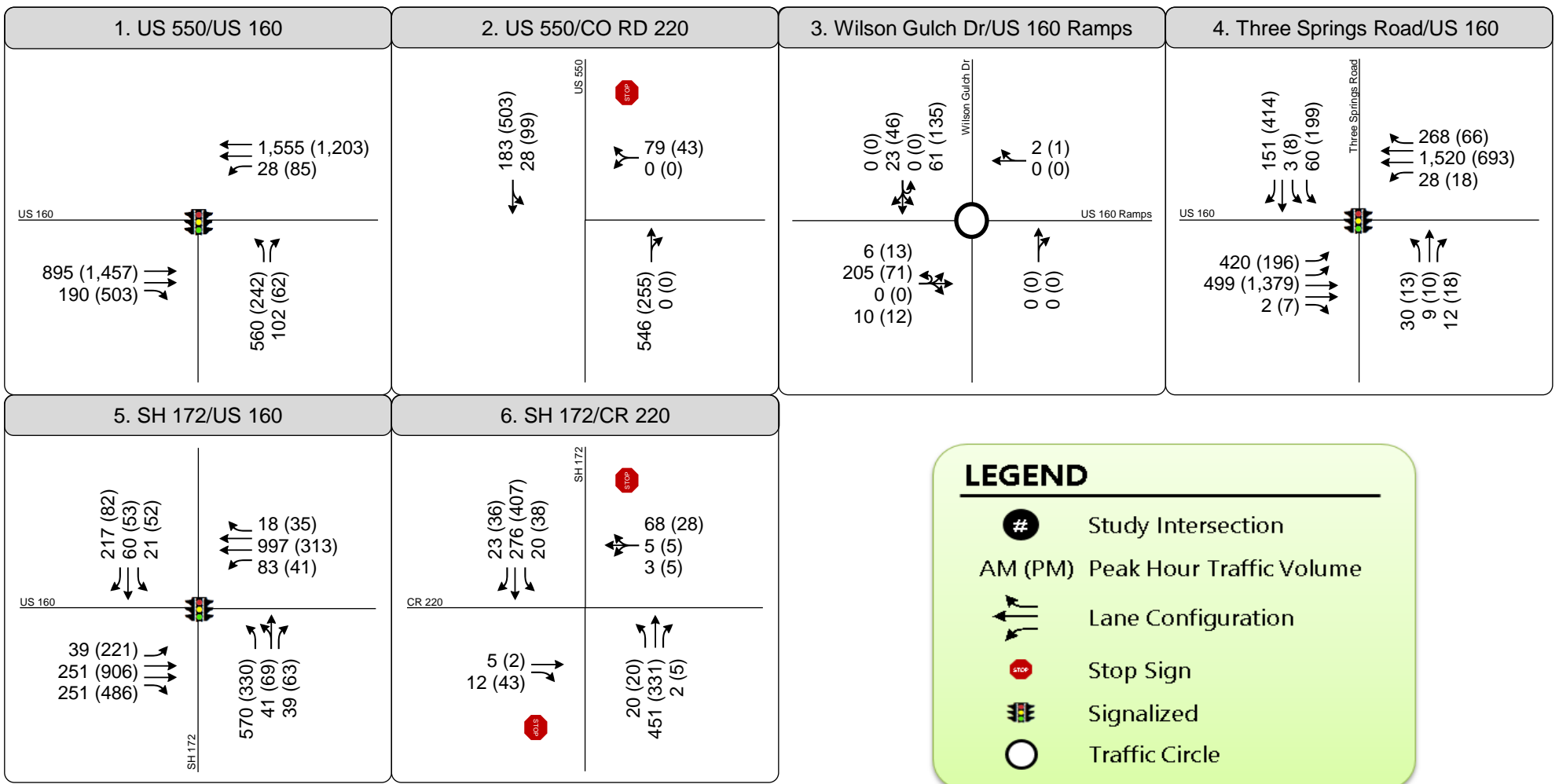
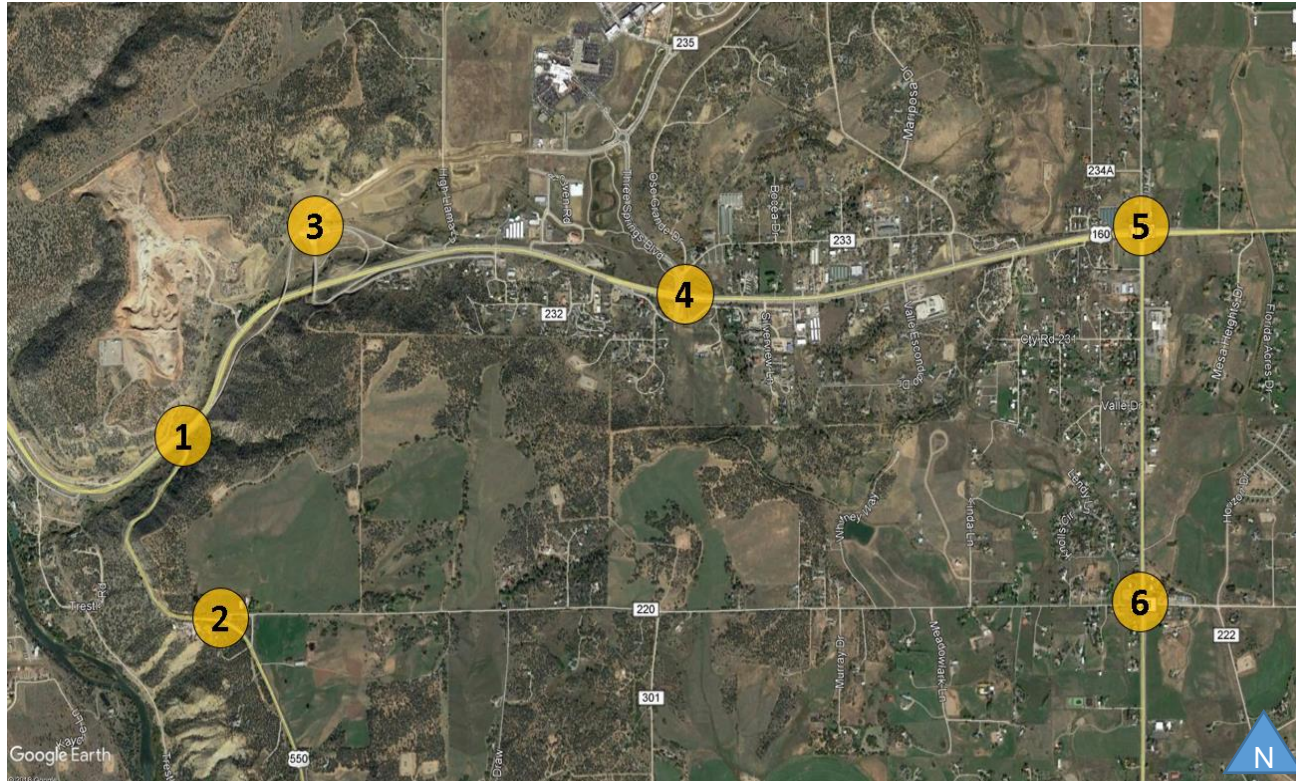

Figure 5.2  
Peak Hour Traffic Volumes  
and Lane Configurations  
Summer Counts



**TABLE 5.1: EXISTING CONDITIONS INTERSECTION LEVEL OF SERVICE RESULTS (SUMMER COUNTS)**

ID	Intersection	Control	Approach	AM		PM	
				Delay	LOS	Delay	LOS
1	US-550/US-160	Signal	<b>Overall</b>	<b>49.4</b>	<b>D</b>	<b>37.6</b>	<b>D</b>
			EB	50.8	D	32.8	C
			NB	46.7	D	60.2	E
2	US-550/CR-220	SSSC	<b>WB</b>	<b>14</b>	<b>B</b>	<b>10.1</b>	<b>B</b>
			NB	0	A	0	A
			SB	8.9	A	1.3	A
3	Wilson Gulch Dr/US-160 Ramps	Roundabout	<b>Overall</b>	<b>4.0</b>	<b>A</b>	<b>3.9</b>	<b>A</b>
			EB	4.3	A	3.9	A
			WB	3.7	A	3.5	A
			NB	3.7	A	3.5	A
			SB	3.3	A	4.0	A
4	US-160/Three Springs Blvd	Signal	<b>Overall</b>	<b>49.1</b>	<b>D</b>	<b>17.9</b>	<b>B</b>
			EB	27.2	C	14.7	B
			WB	61.0	E	13.1	B
			NB	45.3	D	45.9	D
			SB	44.6	D	50.8	D
5	US-160/SH-172	Signal	<b>Overall</b>	<b>50.3</b>	<b>D</b>	<b>22.4</b>	<b>C</b>
			EB	20.6	C	14.0	B
			WB	24.8	C	18.4	B
			NB	106.5	F	43.2	D
			SB	47.5	D	48.2	D
6	SH-172/CR220	SSSC	EB	12.3	B	11.5	B
			<b>WB</b>	<b>13.1</b>	<b>B</b>	<b>13.5</b>	<b>B</b>
			NB	0.3	A	0.5	A
			SB	0.5	A	0.6	A

Notes

1. Signal = signalized intersection; SSSC = Side Street Stop Controlled intersection. For Side street Stop Controlled Intersections, intersection LOS is based on worst approach.
2. Whole intersection weighted average control delay expressed in seconds per vehicle for signalized intersections. At side-street-controlled intersections, the delay and LOS for the worst case movement is reported.

The results indicate that all study intersections operate at acceptable service levels during the AM and PM peak hours under Existing Conditions

**TABLE 5.2: EXISTING CONDITIONS INTERSECTION LEVEL OF SERVICE RESULTS (WINTER COUNTS)**

ID	Intersection	Control	Approach	AM		PM	
				Delay	LOS	Delay	LOS
1	US-550/US-160	Signal	<b>Overall</b>	<b>41.6</b>	<b>D</b>	<b>29.3</b>	<b>C</b>
			EB	38.4	D	23.5	C
			NB	44.7	D	56.2	E
2	US-550/CR-220	SSSC	<b>WB</b>	<b>12.8</b>	<b>B</b>	<b>9.8</b>	<b>A</b>
			NB	0	A	0	A
			SB	1.1	A	1.3	A
3	Wilson Gulch Dr/US-160 Ramps	Roundabout	<b>Overall</b>	<b>3.8</b>	<b>A</b>	<b>3.7</b>	<b>A</b>
			EB	4.1	A	3.5	A
			WB	3.6	A	3.4	A
			NB	3.6	A	3.4	A
			SB	3.2	A	3.8	A
4	US-160/Three Springs Blvd	Signal	<b>Overall</b>	<b>27.6</b>	<b>C</b>	<b>16.4</b>	<b>B</b>
			EB	22.5	C	12.9	B
			WB	29.1	C	12.6	B
			NB	45.4	D	46.1	D
			SB	44.6	D	48.2	D
5	US-160/SH-172	Signal	<b>Overall</b>	<b>34.7</b>	<b>C</b>	<b>20.8</b>	<b>C</b>
			EB	20	C	11.6	B
			WB	20.3	C	16.9	B
			NB	63.8	E	42.8	D
			SB	47.9	D	48.5	D
6	SH-172/CR220	SSSC	EB	12.2	B	11	B
			<b>WB</b>	<b>13.2</b>	<b>B</b>	<b>12.2</b>	<b>B</b>
			NB	0.3	A	0.4	A
			SB	0.5	A	0.6	A

Notes

3. Signal = signalized intersection; SSSC = Side Street Stop Controlled intersection
4. Whole intersection weighted average control delay expressed in seconds per vehicle for signalized intersections. At side-street-controlled intersections, the delay and LOS for the worst case movement is reported.

The results indicate that all study intersections operate at acceptable service levels during the AM and PM peak hours under Existing Conditions.

### 5.3 DAILY TRAFFIC VOLUME PEAKING CHARACTERISTICS

The average weekday volumes along US-160, US-550 and CR-232 are illustrated in **Figures 5.3** through **5.6**.

**Fig 5.3: US-160 West of US-550 Average Weekday Volume**

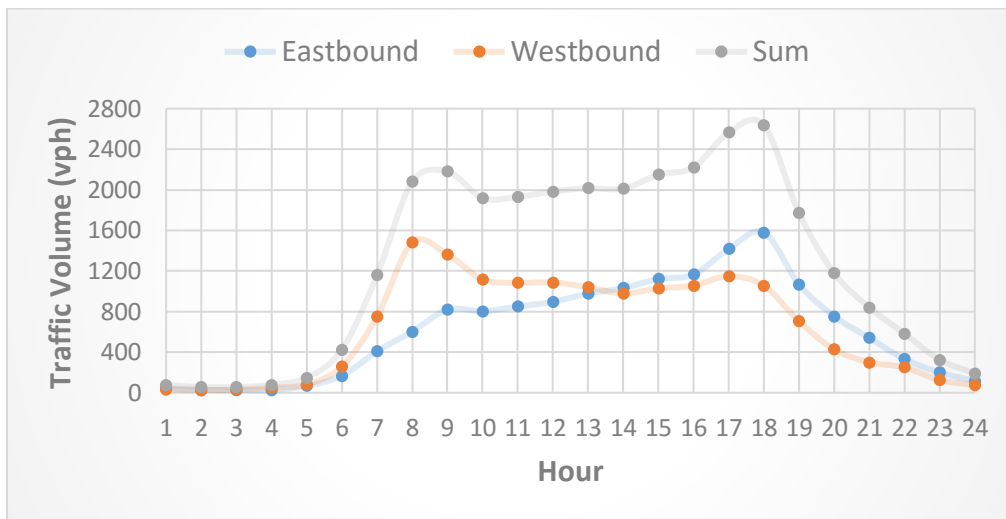

**Fig 5.4: US-160 West of CR-232 Average Weekday Volume**

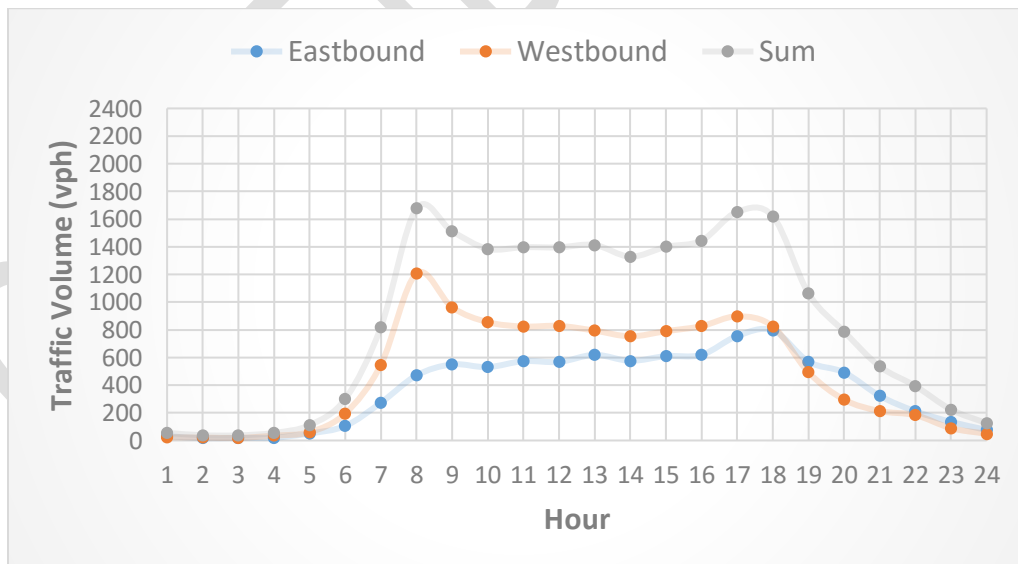

As shown on **Figures 5.3** and **5.4**, traffic volumes on US-160 peak between 7:00 AM and 7:00 PM and reach a maximum flow rate of almost 1700 vph. This time period should be avoided for short-term lane closures or other construction activities. Volumes are lower than 400 vph total between 10:00 PM and 6:00 AM.

Construction activities during this time period would result in much less severe impacts to traffic flow. US-160 does not have much adjacent residential development immediately adjacent to the highway, which reduces the concern about noise impacts during this time period. The entirety of the project is within La Plata County boundaries, so additional coordination with the County should be considered to discuss any additional noise concerns.

**Fig 5.5: US-550 South of US-160 Average Weekday Volume**

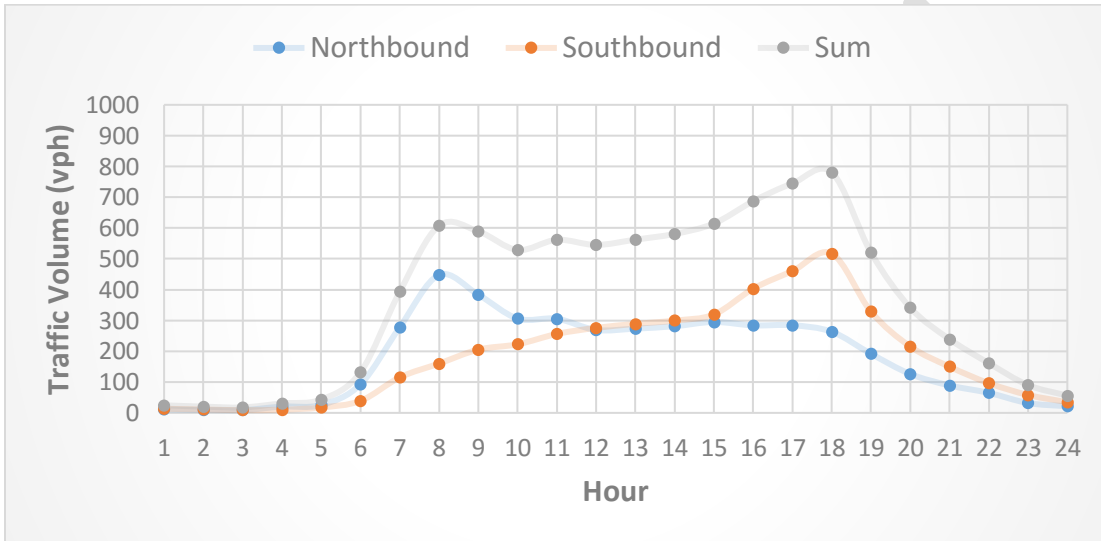

As shown on **Figure 5.5**, traffic peaking on US-550 is similar to US-160 in that traffic tends to peak between 7:00 AM and 7:00 PM and reaches a maximum of 800 vph. However, the overall traffic volumes are much lower on US-550. Traffic volumes are less than 100 vph total between 11:00 PM and 6:00 AM.

**Fig 5.6: CR-220 east of US-550 Average Weekday Volume**

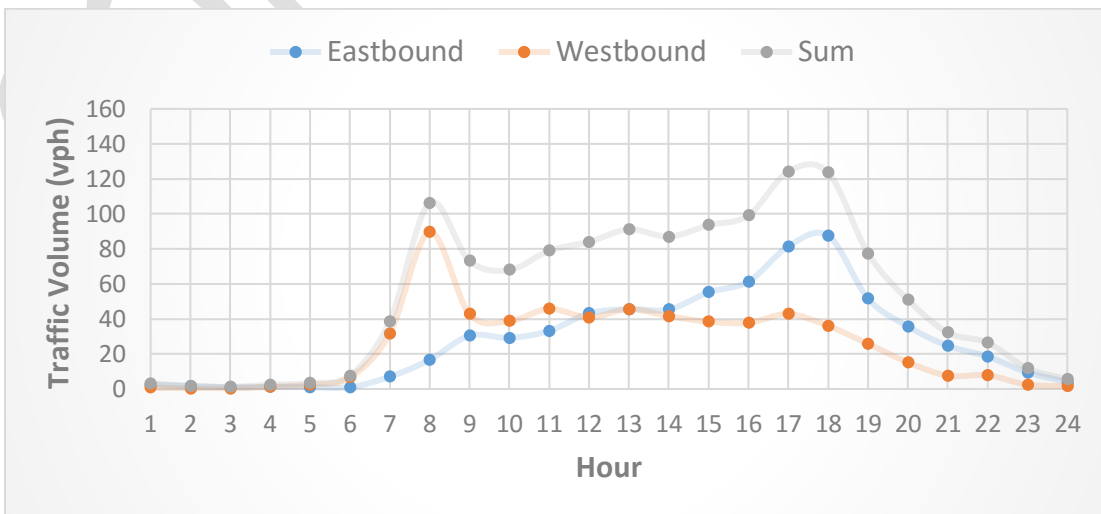

As shown on **Figure 5.6**, traffic volumes are even lower on CR-220. Peaks are still between 7:00 AM and 7:00 PM, with volumes less reaching a maximum of 130 vph. Volumes are less than 20 vph between 11:00 PM and 6:00 AM.

If short-term off-peak closures are necessary for construction, they should be limited to coincide with the time period when traffic volumes are lowest, which is 11:00 PM until 6:00 AM.

Long-term closures of any of these facilities would impact the following volume of traffic:

- US-160 long-term closures would impact 20769 daily trips
- US-550 long-term closures would impact 8874 daily trips
- CR-220 long-term closures would impact 1292 daily trips

CONFIDENTIAL



## 6.0 MAINTENANCE OF TRAFFIC ANALYSIS

### 6.1 INTRODUCTION

For this analysis, it was assumed that the project would be broken into the following logical segments as shown in **Figure 6.1**:

- Segment 1: Station 810+00 to 865+00
- Segment 2: Station 865+00 to 880+00
- Segment 3: Station 880+00 to 975+00
- Segment 4: Station 975+00 to 987+00
- Segment 5: Station 987+00 to 1040+87

The MOT analysis was completed in three steps:

- 1) Determine a logical phasing scheme for the project, and
- 2) Evaluate what the traffic impacts of that phasing scheme may be
- 3) Recommend constraints and limitations on lane closures.

### 6.2 ANTICIPATED CONSTRUCTION PHASING

The following sections present our proposed phasing/stages for construction. This is expected to facilitate efficient traffic mobility during the construction. The bidders would be required to develop an Alternative Technical Concept (ATC) which is equal to or better than what is proposed in this report.

#### 6.2.1 SEGMENT 1

This area is from the south end of the project near the 12 Mile Road intersection to a private driveway near Station 865+00. Within Segment 1, the eastern ½ of the proposed roadway is outside of the limits of the existing corridor. This segment could be constructed in two major traffic phases as shown in **Figure 6.2**:

- Phase 1: Construct the eastern portion of the new highway, while maintaining traffic on the existing corridor.
- Phase 2: Shift both directions of traffic to the newly constructed eastern half of the highway and construct the new western portion.

Upon completion of these two phases, traffic could be shifted into its final configuration. This segment should be able to be constructed without implementing any long-term closures.



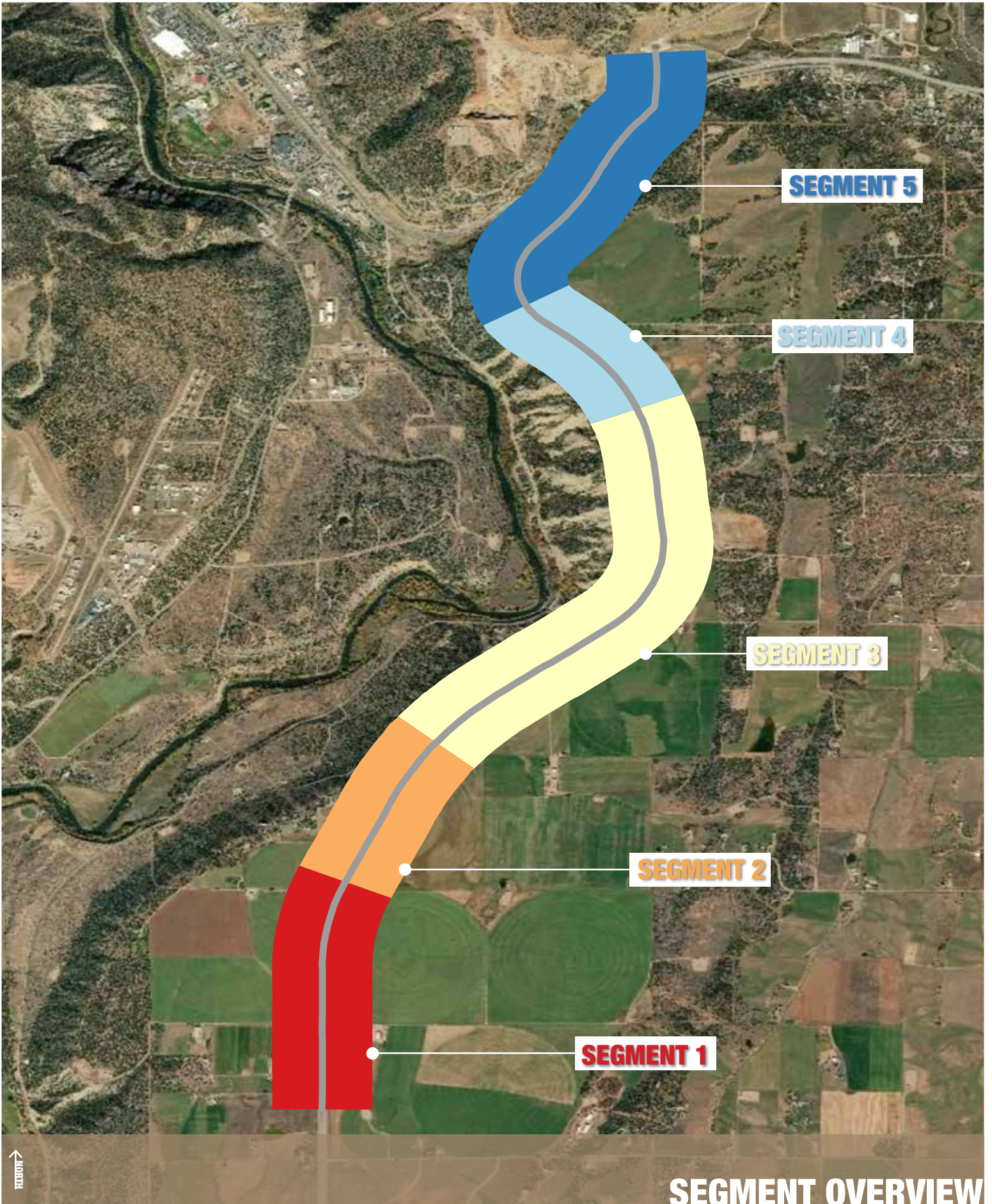

**SEGMENT 5**

**SEGMENT 4**

**SEGMENT 3**

**SEGMENT 2**

**SEGMENT 1**

# SEGMENT OVERVIEW

Figure 6.1



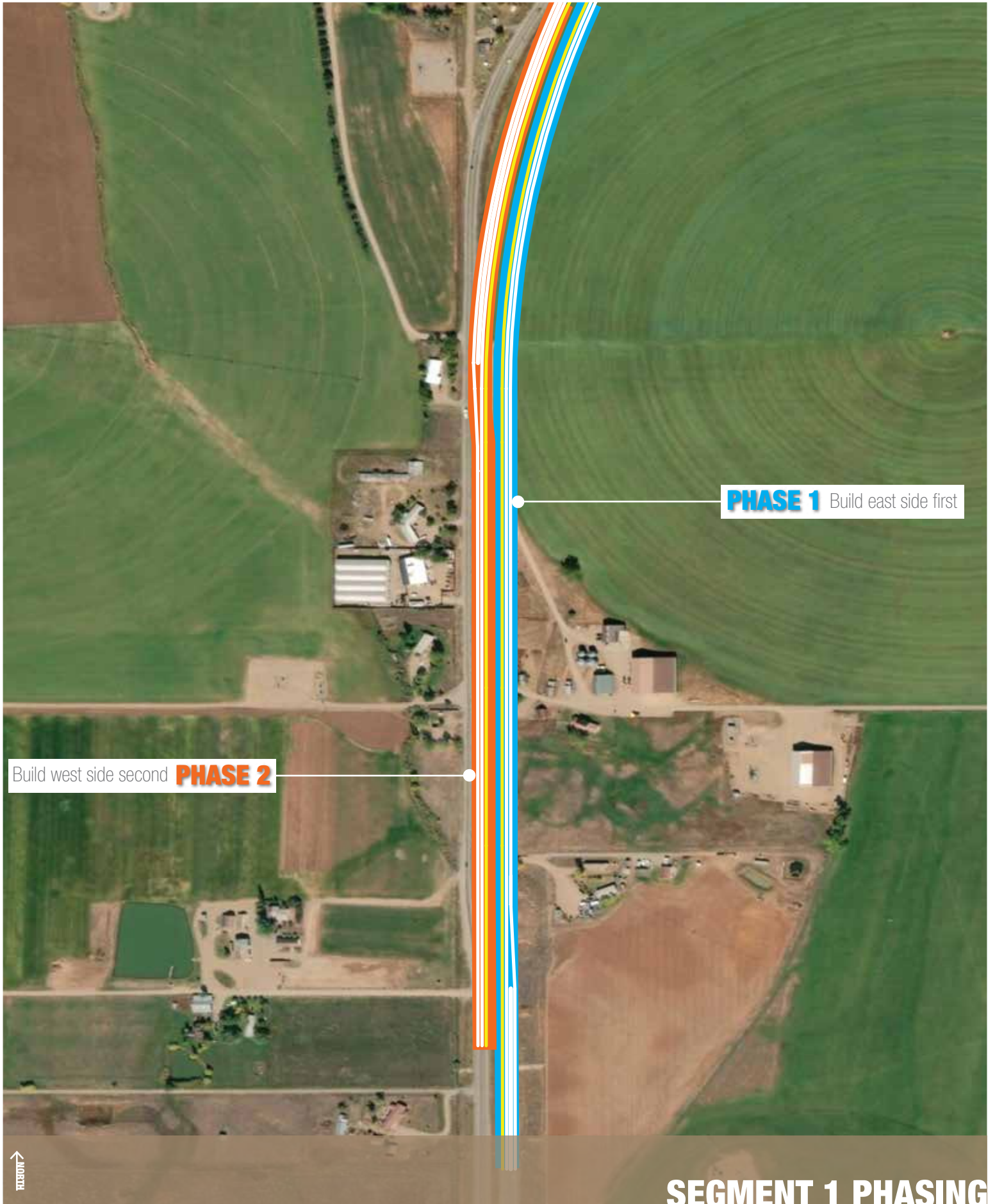

**PHASE 1** Build east side first

Build west side second **PHASE 2**

# SEGMENT 1 PHASING

Figure 6.2

## 6.2.2 SEGMENT 2

This area is from the private driveway near Station 865+00 to the intersection of Bardin Dr. (CR-219). Within Segment 2, the proposed highway alignment transitions back and forth over the current roadway. Due to this complication, this segment of the project will require a more complicated construction approach. This segment could be constructed in these major traffic phases as shown in **Figure 6.3**:

- 1) Phase 1: Construct the eastern or western half of the corridor wherever it does not conflict with the current configuration, while maintaining traffic on the existing corridor.
- 2) Phase 2: Shift traffic onto the newly constructed pavement, while constructing the remaining pavement. This will require temporary pavement (cross-over points) between the eastern and western halves of the roadway at several locations.
- 3) Phase 3: Clean-up the areas where the temporary pavement was required and tie the portions of highway constructed in Phases 1 and 2 together.

Upon completion of these three phases, traffic could be shifted to its final configuration. Construction and implementation of the temporary cross-overs may require slightly longer closures, as may the tie-ins during Phase 3.

## 6.2.3 SEGMENT 3

This area is from the intersection of Bardin Dr. (CR-219) to just south of CR-220. Similar to Segment 1, the eastern portion of the new highway is completely outside of the existing alignment. Construction phasing in this area could be consistent with impacts in Segment 1, and no long-term closures are needed.

## 6.2.4 SEGMENT 4

This area is immediately adjacent to CR-220 and will require temporary cross-overs similar to Segment 2 along with a sub phase to deal with the CR-220 intersection reconfiguration. This segment could be built in three major phases as shown in **Figure 6.4**:

- Phase 1: Construct the western portion of the new highway as well as the frontage road to the west of the new alignment. All traffic would be maintained along the existing highways during this phase.
- Phase 2: Traffic on SR-550 would be shifted to the newly constructed pavement on the west side of the new highway. CR-220 would need to be temporarily maintained at the primary intersection with SR-550 during this phase. The eastern leg of the SR-550 / CR-220 intersection



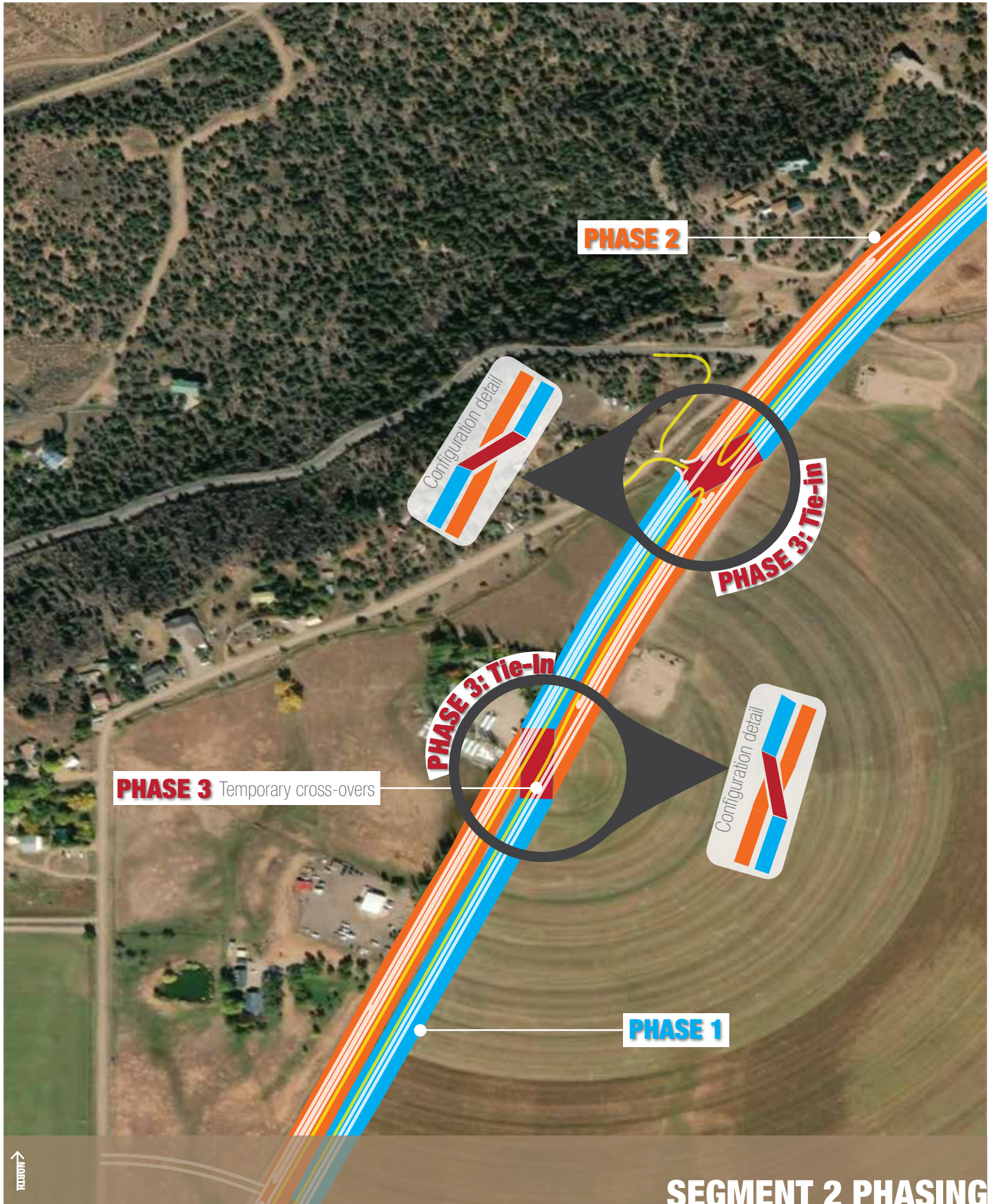

# SEGMENT 2 PHASING

Figure 6.3





# SEGMENT 4 PHASING

Figure 6.4

"triangle" would be closed during this time to facilitate construction of the new CR-220 alignment.

- 4) Phase 3: Clean-up the areas where the temporary pavement was required and tie the portions of highway constructed in Phases 1 and 2 together.

Upon completion of these three phases, traffic could be shifted to its final configuration. Construction and implementation of the temporary cross-overs may require slightly longer closures, as may the tie-ins during Phase 3.

### 6.2.5 SEGMENT 5

This area is primarily outside of the limits of the existing highway and should be able to be mostly constructed in a single phase. However, construction of the new roundabout at the US-160/US-550 interchange will have some impacts on traffic. Specifically, it is anticipated that construction activities may impact traffic operations on mainline US-160 due to construction staging below the interchange. It is also anticipated that construction may require closing Ramp B on the existing 550 bridge over 160 for the duration of construction as shown in **Figure 6.5**. See the Traffic Analysis section below for details on these impacts. Segment 5 also contains the existing intersection at US-160 / US-550 which will need to be abandoned with this project. This construction activity is also expected to have a potential impact on traffic.

### 6.2.6 OTHER CONSIDERATIONS

While the construction phasing presented does not necessarily require long-term full closures of US-550 or CR-220, allowing these closures may enable accelerated construction or expanded scope due to better use of resources. For this reason, long-term closures of these two facilities are analyzed as presented below.

## 6.3 TRAFFIC ANALYSIS

The first step in analyzing potential traffic impacts is to evaluate how any full roadway closures may impact mobility during construction. An evaluation of potential detour routes was considered if any long-term full roadway closures are needed.

### 6.3.1 RAMP B CLOSURE

It is anticipated that Ramp B at the existing US-160 / Wilson Gulch interchange will need to be closed during construction as shown in **Figure 6.4** to facilitate demolition of the existing shotcrete wall and excavation for construction of the new roundabout. This will require detouring traffic that is currently using this ramp. Fortunately the traffic volumes on the ramp are not significant and should be able to be detoured without major disruption to area mobility. The proposed detour route during closure of this ramp would impact two



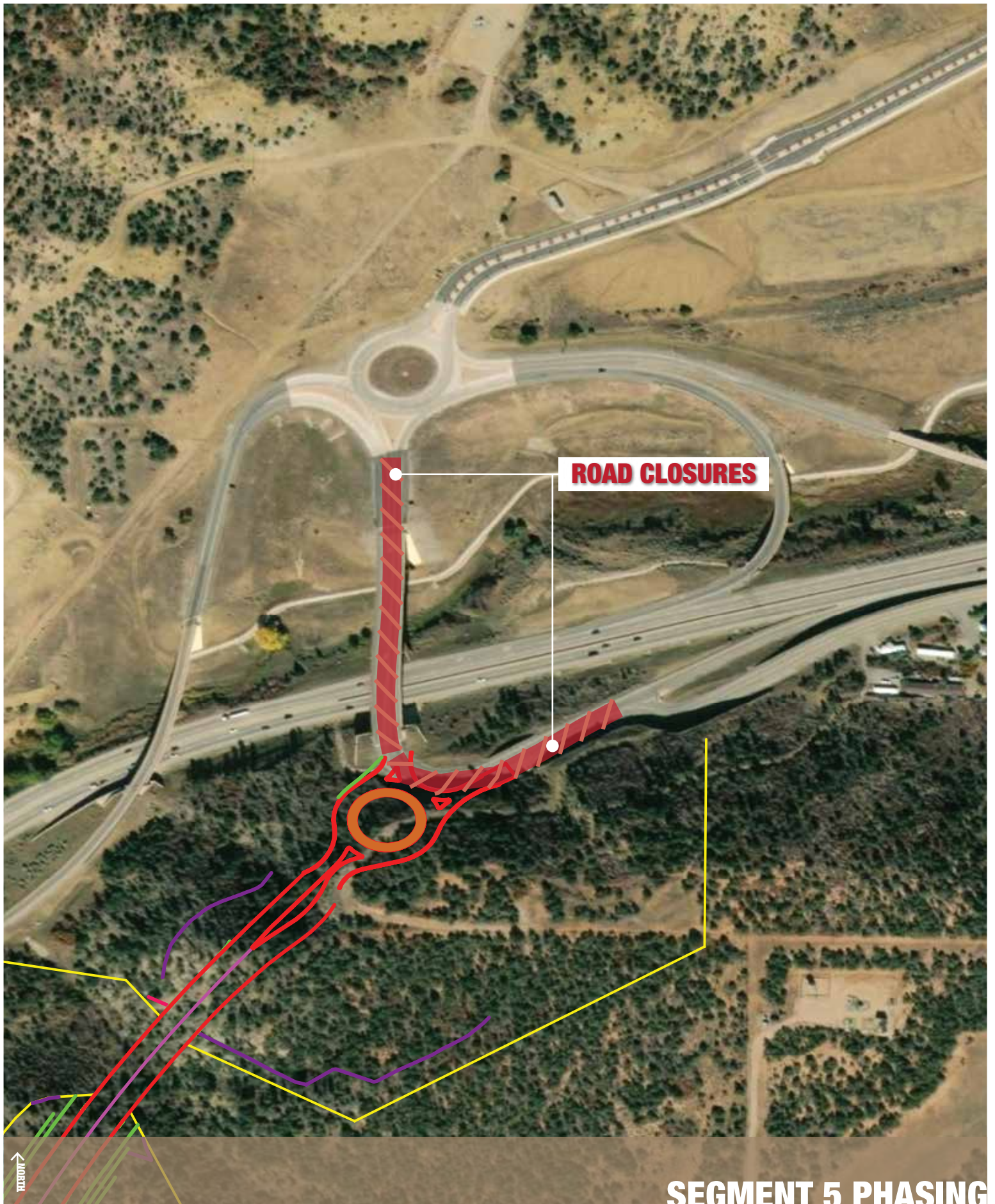

# SEGMENT 5 PHASING

Figure 6.5



movements: eastbound right turning vehicles and southbound through vehicles at the US-160 / Wilson Gulch interchange. There are no westbound left-turning vehicles at the interchange.

The eastbound right turning and southbound through vehicles travel along Ramp B for two possible routes: 1) Route to EB US-160 and 2) Route to CR-232. Let's assume that all of the eastbound right traffic are routed to CR-232, 80% of the southbound traffic are routed to EB US-160 and 20% of the southbound traffic are routed to CR-232 after Ramp B Closure

A potential detour for these two movements would be taking the Eastbound Wilson Gulch Drive and then taking a right on to Three Springs Blvd, which provides access to US-160. In the AM peak period, 33 vehicles will need to be rerouted and in the PM peak period, 58 vehicles will need to be rerouted.

The original route and the detours along these two possible routes are shown below:

**Fig 6.5: Original Route to EB US-160**



**Fig 6.6: Detour to EB US-160**

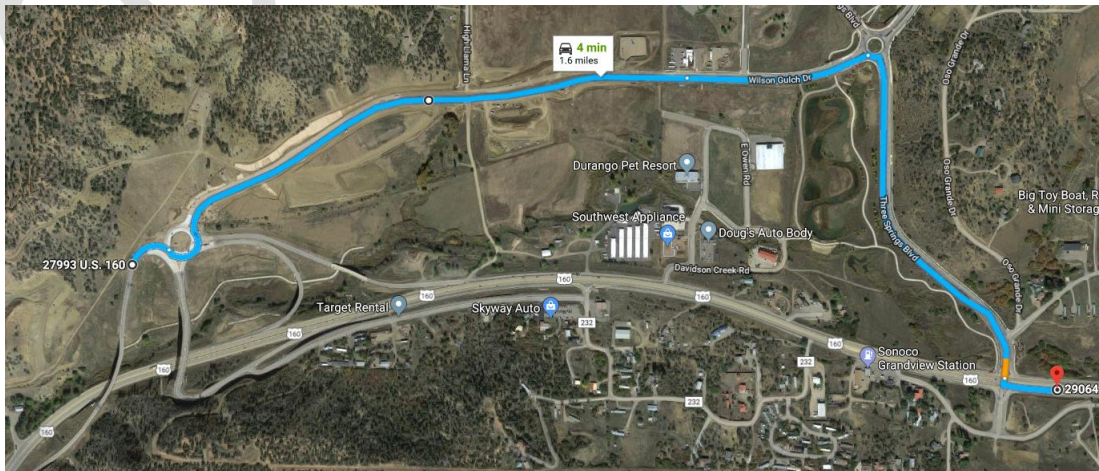



The detour map shows that the travel time increases by 2 minutes.

**Fig 6.7: Original Route to CR-232**



**Fig 6.8: Detour to CR-232**

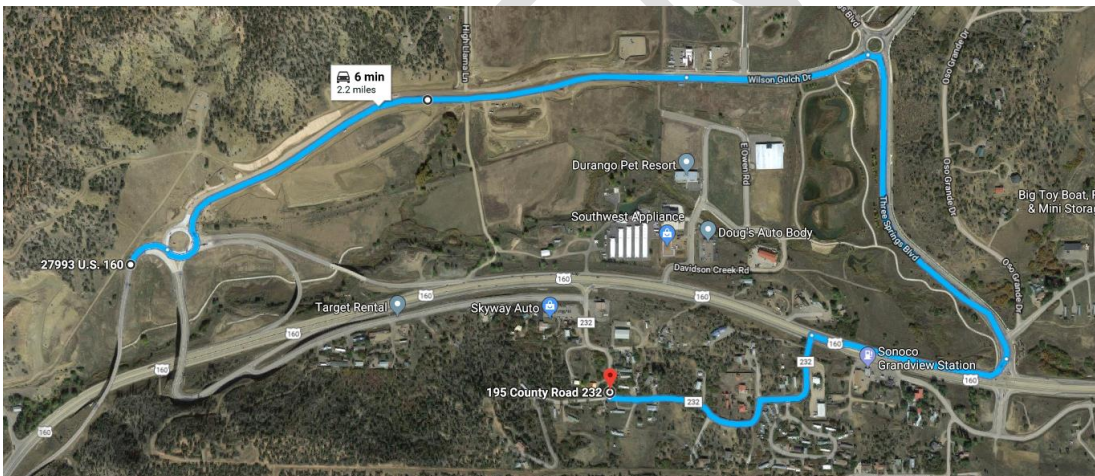

The detour map shows that the travel time increases by 3 minutes.

The resulting detour would increase travel time for those impacted by 2-3 minutes. Additionally, an assessment of the impact of this detour on traffic operations at the Wilson Gulch Dr. / US-160 intersection and the US-160/Three Springs intersection was completed as shown in **Table 6.1** and **Table 6.2**.

**Table 6.1: Intersection Performance with Detour (Summer Counts)**

Intersection	Control	Approach	AM		AM (Detour)		PM		PM (Detour)	
			Delay	LOS	Delay	LOS	Delay	LOS	Delay	LOS
Wilson Gulch Dr. / US-160 Ramps	Roundabout	<b>Overall</b>	<b>4</b>	<b>A</b>	<b>4.3</b>	<b>A</b>	<b>3.9</b>	<b>A</b>	<b>4</b>	<b>A</b>
		EB	4.3	A	4.7	A	3.7	A	4.2	A
		WB	3.7	A	3.8	A	3.5	A	3.7	A
		NB	3.7	A	N/A	N/A	3.5	A	N/A	N/A
		SB	3.3	A	3.3	A	4	A	4	A
US-160 / Three Springs Blvd	Signal	<b>Overall</b>	<b>49.1</b>	<b>D</b>	<b>49.3</b>	<b>D</b>	<b>17.9</b>	<b>B</b>	<b>19.6</b>	<b>B</b>
		EB	27.2	C	27.9	C	14.7	B	14.7	B
		WB	61.0	E	61.0	E	13.1	B	13.1	B
		NB	45.3	D	45.3	D	45.9	D	45.9	D
		SB	44.6	D	45.0	D	50.8	D	61.0	E

**Table 6.2: Intersection Performance with Detour (Winter Counts)**

Intersection	Control	Approach	AM		AM (Detour)		PM		PM (Detour)	
			Delay	LOS	Delay	LOS	Delay	LOS	Delay	LOS
Wilson Gulch Dr. / US-160 Ramps	Roundabout	<b>Overall</b>	<b>3.8</b>	<b>A</b>	<b>4.0</b>	<b>A</b>	<b>3.7</b>	<b>A</b>	<b>3.8</b>	<b>A</b>
		EB	4.1	A	4.4	A	3.5	A	3.9	A
		WB	3.6	A	3.7	A	3.4	A	3.6	A
		NB	3.6	A	N/A	N/A	3.4	A	N/A	N/A
		SB	3.2	A	3.2	A	3.8	A	3.8	A
US-160 / Three Springs Blvd	Signal	<b>Overall</b>	<b>27.6</b>	<b>C</b>	<b>27.9</b>	<b>C</b>	<b>16.4</b>	<b>B</b>	<b>17.7</b>	<b>B</b>
		EB	22.5	C	22.9	C	12.9	B	12.9	B
		WB	29.1	C	29.1	C	12.6	B	12.6	B
		NB	45.4	D	45.4	D	46.1	D	46.1	D
		SB	44.6	D	44.9	D	48.2	D	53.9	D

Analysis shows that for summer and winter counts, LOS is maintained at LOS D or better for all conditions, and that individual approaches are LOS E or better. The queuing reports do not show any significant change in queue lengths. For winter counts, closing Ramp B does not impact either intersection either. LOS is maintained at LOS D or better for all conditions. The queuing reports do not show any significant change in queue lengths. Therefore, this closure meets mobility thresholds for LOS requirements during both summer and winter conditions.

The closure of Ramp B would meet the mobility thresholds for travel time, delays and queueing. Therefore, it is recommended that the proposers be allowed to close Ramp B for the duration of the project.

### 6.3.2 US-160 / US-550 LANE CLOSURE

It is possible that lanes will need to be closed on US-160 at or near the current US-550 intersection to accommodate demolition of the existing intersection, reconstruction of the median or construction phasing for the new intersection. A closure of US-160 would impact **20,800 daily trips**. To evaluate this potential impact, an analysis was completed to evaluate how closing lanes may impact delay. The following intersection analyses were carried out at US-160/US-550:

- Closing one eastbound through lane
- Closing one westbound through lane
- Closing one eastbound and one westbound through lane

For the purpose of this analysis, it was assumed that these lane closures would be implemented prior to opening the new US-550/US-160 intersection. **Tables 6.2** through **6.7** shows the resulting delays at the intersection.

**Table 6.2: Intersection Performance with 1 EB Lane Closure (Summer Counts)**

Intersection	Control	Approach	AM		AM (With 1 EB Lane Closure)		PM		PM (With 1 EB Lane Closure)	
			Delay	LOS	Delay	LOS	Delay	LOS	Delay	LOS
US-550/US-160	Signal	<b>Overall</b>	<b>49.4</b>	<b>D</b>	<b>250.2</b>	<b>F</b>	<b>37.6</b>	<b>D</b>	<b>323.5</b>	<b>F</b>
		EB	50.8	D	406.4	F	32.8	C	382.8	F
		NB	46.7	D	46.7	D	60.2	E	60.2	E

**Table 6.3: Intersection Performance with 1 EB Lane Closure (Winter Counts)**

Intersection	Control	Approach	AM		AM (With 1 EB Lane Closure)		PM		PM (With 1 EB Lane Closure)	
			Delay	LOS	Delay	LOS	Delay	LOS	Delay	LOS
US-550/US-160	Signal	<b>Overall</b>	<b>41.6</b>	<b>D</b>	<b>190.7</b>	<b>F</b>	<b>29.3</b>	<b>C</b>	<b>238.0</b>	<b>F</b>
		EB	38.4	D	302.3	F	23.5	C	279.0	F
		NB	44.7	D	44.7	D	56.2	E	56.2	E

**Table 6.4: Intersection Performance with 1 WB Lane Closure (Summer Counts)**

Intersection	Control	Approach	AM		AM (With 1 WB Lane Closure)		PM		PM (With 1 WB Lane Closure)	
			Delay	LOS	Delay	LOS	Delay	LOS	Delay	LOS
US-550/US-160	Signal	<b>Overall</b>	<b>49.4</b>	<b>D</b>	<b>49.4</b>	<b>D</b>	<b>37.6</b>	<b>D</b>	<b>37.6</b>	<b>D</b>
		EB	50.8	D	50.8	D	32.8	C	32.8	C
		NB	46.7	D	46.7	D	60.2	E	60.2	E

**Table 6.5: Intersection Performance with 1 WB Lane Closure (Winter Counts)**

Intersection	Control	Approach	AM		AM (With 1 WB Lane Closure)		PM		PM (With 1 WB Lane Closure)	
			Delay	LOS	Delay	LOS	Delay	LOS	Delay	LOS
US-550/US-160	Signal	Overall	41.6	D	41.6	41.6	29.3	C	29.3	C
		EB	38.4	D	38.4	38.4	23.5	C	23.5	C
		NB	44.7	D	44.7	44.7	56.2	E	56.2	E

**Table 6.6: Intersection Performance with 1 EB & 1 WB Lane Closure (Summer Counts)**

Intersection	Control	Approach	AM		AM (With 1 EB & 1 WB Lane Closure)		PM		PM (With 1 EB & 1 WB Lane Closure)	
			Delay	LOS	Delay	LOS	Delay	LOS	Delay	LOS
US-550/US-160	Signal	Overall	49.4	D	250.2	F	37.6	D	323.5	F
		EB	50.8	D	406.4	F	32.8	C	382.8	F
		NB	46.7	D	46.7	D	60.2	E	60.2	E

**Table 6.7: Intersection Performance with 1 EB & 1 WB Lane Closure (Winter Counts)**

Intersection	Control	Approach	AM		AM (With 1 EB & 1 WB Lane Closure)		PM		PM (With 1 EB & 1 WB Lane Closure)	
			Delay	LOS	Delay	LOS	Delay	LOS	Delay	LOS
US-550/US-160	Signal	Overall	41.6	D	190.7	F	29.3	C	238.0	F
		EB	38.4	D	302.3	F	23.5	C	279.0	F
		NB	44.7	D	44.7	D	56.2	E	56.2	E

As shown in **Tables 6.2** through **6.7**:

- Closing an EB lane changes the intersection LOS from D to F for both summer and winter.
- Closing a WB lane has no impact on intersection LOS, most likely because the WB lane has free flow of traffic.
- Closing an EB and a WB lane has the same impact as closing only an EB lane.

### Queueing

An evaluation of queueing was completed for this lane closure, and it was determined that:

- Closing an EB lane increases the queue length by a substantial extent.
- Closing a WB lane has no impact on queue length.
- Closing an EB and a WB lane has the same impact as closing only an EB lane.

Details of the resulting queue lengths are provided in the **Appendix B**. Based on these results it is recommended that EB lane closures are not allowed during peak hours. While WB lane closures resulted in acceptable results, it is anticipated that long-term, peak-period closures WB would also likely result in frustration by the traveling public as US-160 is a critical facility. For this reason, it is also recommended that WB peak-period lane closures not be allowed on US-160. Lane closures should be restricted to short-term off-peak time periods only.



### 6.3.3 US-550 FULL CLOSURE

While it is not anticipated that long-term closures of US-550 would be needed, an evaluation of potential detours for US-550 was completed to evaluate the impacts thereof. If US-550 were to be closed, it would impact **8,900 daily trips**. The following potential detours scenarios exist:

- 1) A regional detour southbound on US-550 to Aztec, NM; westbound on NM CR-574 to La Plata, NM; northbound on NM SR-170/CO SR-140 to Hesperus, CO, and eastbound on US-160 to Durango with reverse as shown on **Figure 6.9**.
- 2) A local detour eastbound on CR-302, northbound on CR-301, eastbound on CR-220, northbound on SR-172, and westbound on US-160 with reverse as shown on **Figure 6.10**.
- 3) A local detour eastbound/northbound on CR-302, northbound on SR-172, westbound on US-160 with reverse as shown on **Figure 6.11**.

**Figure 6.9. US-550 Detour Scenario 1**

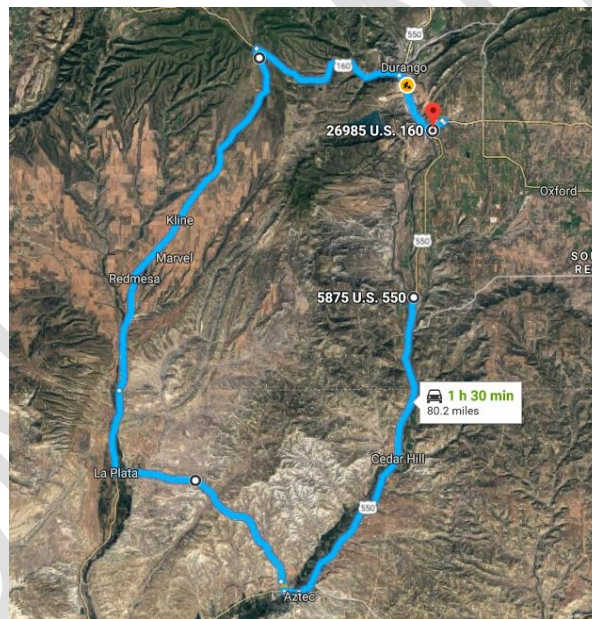

This route would represent approximately 80 miles (90 minutes of travel time) of out-of-direction travel and is an excessive delay to the traveling public. This route would also detour traffic into New Mexico, and would require coordination with NMDOT, San Juan County, and La Plata County. For these reasons, this route is not recommended.





Based on the impacts and required coordination effort, Detour scenario 1 is not recommended. Detour scenarios 2 and 3 have similar impacts and would require coordination with La Plata County. Detour 3 would have the fastest out-of-direction travel time and would be within the mobility thresholds identified.

An evaluation of the impacts of detour routes 2 and 3 to LOS on adjacent intersections on US-160 was completed. The results are presented in **Table 6.8 and 6.9**.

**Table 6.8: Intersection Performance with US-550 closure (Summer Counts)**

ID	Intersection	Control	Approach	AM		AM (Detour)		PM		PM (Detour)	
				Delay	LOS	Delay	LOS	Delay	LOS	Delay	LOS
4	US-160 / Three Springs Blvd	Signal	<b>Overall</b>	<b>49.1</b>	<b>D</b>	<b>170.1</b>	<b>F</b>	<b>17.9</b>	<b>B</b>	<b>41.1</b>	<b>D</b>
			EB	27.2	C	22.0	B	14.7	B	48.0	D
			WB	61.0	E	252.2	F	13.1	B	13.1	B
			NB	45.3	D	45.3	D	45.9	D	45.9	D
			SB	44.6	D	44.6	D	50.8	D	50.8	D
5	US-160 / SH-172	Signal	<b>Overall</b>	<b>50.3</b>	<b>D</b>	<b>343.5</b>	<b>F</b>	<b>22.4</b>	<b>C</b>	<b>38.5</b>	<b>D</b>
			EB	20.6	C	21.1	C	14.0	B	20.2	C
			WB	24.8	C	24.7	C	18.4	B	23.2	C
			NB	106.5	F	678.7	F	43.2	D	73.9	E
			SB	47.5	D	47.5	D	48.2	D	48.2	D
6	SH-172/ CR-220	SSSC	EB	12.3	B	27.5	D	11.5	B	15.2	C
			<b>WB</b>	<b>13.1</b>	<b>B</b>	<b>49.5</b>	<b>E</b>	<b>13.5</b>	<b>B</b>	<b>25.6</b>	<b>D</b>
			NB	0.3	A	0.1	A	0.5	A	0.3	A
			SB	0.5	A	0.4	A	0.6	A	0.5	A

**Table 6.9: Intersection Performance with US-550 closure (Winter Counts)**

ID	Intersection	Control	Approach	AM		AM (Detour)		PM		PM (Detour)	
				Delay	LOS	Delay	LOS	Delay	LOS	Delay	LOS
4	US-160 / Three Springs Blvd	Signal	<b>Overall</b>	<b>27.6</b>	<b>C</b>	<b>115.7</b>	<b>F</b>	<b>16.4</b>	<b>B</b>	<b>20.9</b>	<b>C</b>
			EB	22.5	C	19.1	B	12.9	B	20.8	C
			WB	29.1	C	165.6	F	12.6	B	13.8	B
			NB	45.4	D	45.4	D	46.1	D	46.1	D
			SB	44.6	D	44.6	D	48.2	D	48.2	D
5	US-160 / SH-172	Signal	<b>Overall</b>	<b>34.7</b>	<b>C</b>	<b>275.5</b>	<b>F</b>	<b>20.8</b>	<b>C</b>	<b>29.2</b>	<b>C</b>
			EB	20	C	20	C	11.6	B	16.8	B
			WB	20.3	C	20.3	C	16.9	B	21.4	C
			NB	63.8	E	538.4	F	42.8	D	49.7	D
			SB	47.9	D	47.9	D	48.5	D	48.5	D
6	SH-172/ CR-220	SSSC	EB	12.2	B	27.2	D	11	B	13.7	B
			<b>WB</b>	<b>13.2</b>	<b>B</b>	<b>52</b>	<b>F</b>	<b>12.2</b>	<b>B</b>	<b>19.3</b>	<b>C</b>
			NB	0.3	A	0.1	A	0.4	A	0.2	A
			SB	0.5	A	0.4	A	0.6	A	0.5	A

As shown in **Table 6.8 and 6.9**, the detour results in LOS F conditions at US-160 / Three Springs Blvd. and at US-160/ SH-172 intersections during the Summer and winter AM peak hour. Queueing was also evaluated, and it was identified that the US-550 Full Closure would exceed available storage (and dramatically worsen) queues for the following movements:

- Northbound left at US-160 / Three Springs Blvd
- Northbound through at US-160 / Three Springs Blvd
- Westbound through at US-160 / SH-172

This closure would result in impacts that exceed the allowed mobility thresholds and should not be permitted for summer or winter conditions.

### 6.3.4 CR-220 DETOURS

While it is not anticipated that long-term closures are needed on CR-220, allowing a long-term closure of this facility would potentially speed up construction activities. If CR-220 were to be closed it would impact **1300 daily trips**. **Figure 6.12 and 6.13** show potential routes for the detour.

**Figure 6.12.** CR-220 Detour Scenario 1

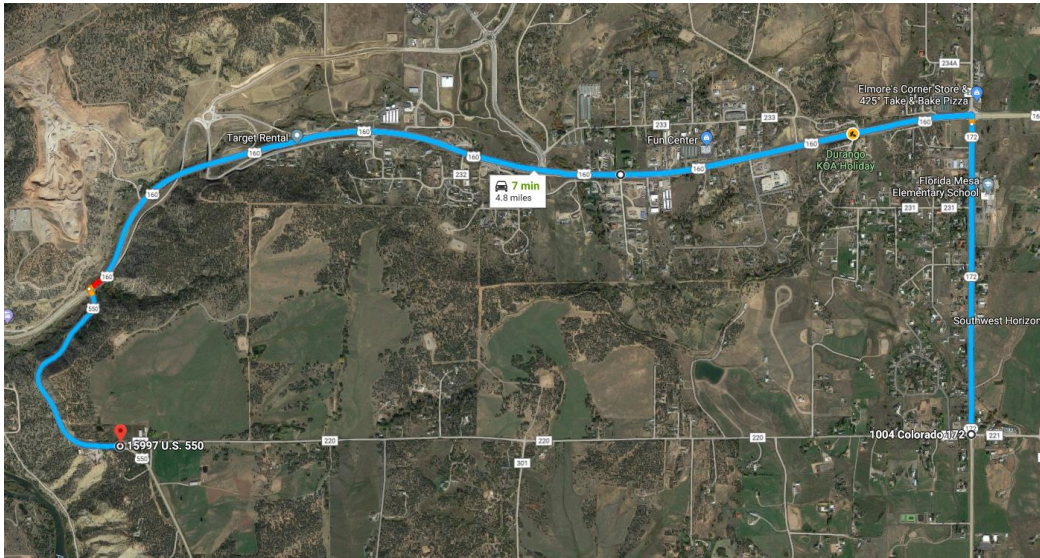

This route represents 4.8 miles (7 minutes of travel time) of out of direction travel.

**Figure 6.13.** CR-220 Detour Scenario 2

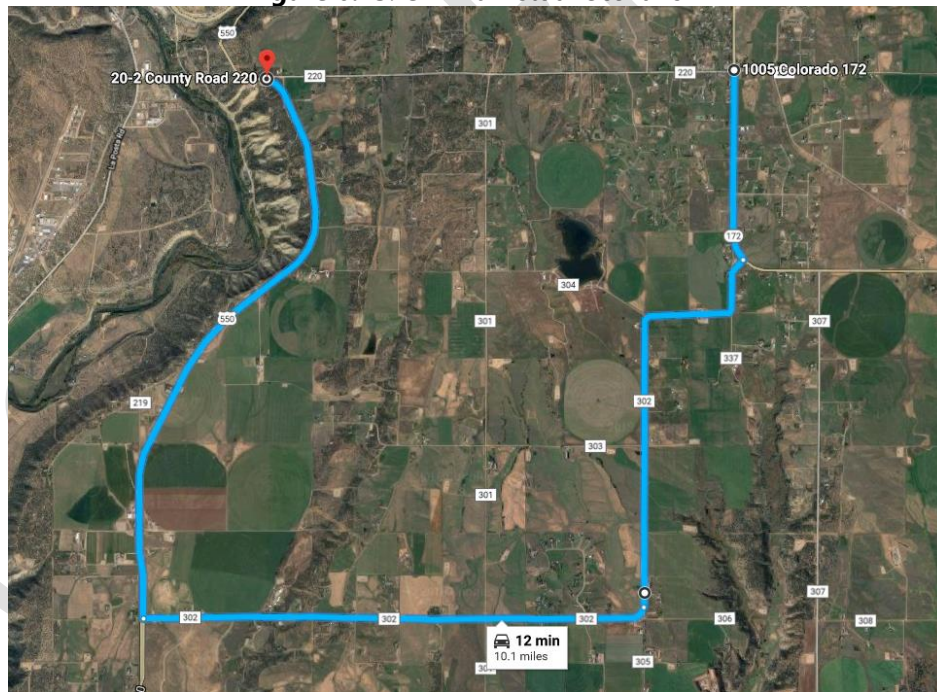

This route represents 10.1 miles (12 minutes of travel time) of out of direction travel. CR-220 Detour Scenarios 1 and 2 would be within the 20 minute threshold identified.

An evaluation of the impacts of detour routes 1 to LOS on adjacent intersections on US-160 was completed. The results are presented in **Table 6.10**.

**Table 6.10: Intersection Performance with CR-220 Closure (Summer Counts)**

ID	Intersection	Control	Approach	AM		AM (Detour)		PM		PM (Detour)	
				Delay	LOS	Delay	LOS	Delay	LOS	Delay	LOS
4	US-160 / Three Springs Blvd	Signal	<b>Overall</b>	<b>49.1</b>	<b>D</b>	<b>64.9</b>	<b>E</b>	<b>17.9</b>	<b>B</b>	<b>17.8</b>	<b>B</b>
			EB	27.2	C	27.2	C	14.7	B	14.7	B
			WB	61.0	E	<b>85.2</b>	<b>F</b>	13.1	B	13.3	B
			NB	45.3	D	45.3	D	45.9	D	45.9	D
			SB	44.6	D	44.6	D	50.8	D	50.8	D
5	US-160 / SH-172	Signal	<b>Overall</b>	<b>50.3</b>	<b>D</b>	<b>75.8</b>	<b>E</b>	<b>22.4</b>	<b>C</b>	<b>23.9</b>	<b>C</b>
			EB	20.6	C	20.6	C	14.0	B	15.1	B
			WB	24.8	C	24.8	C	18.4	B	19.2	B
			NB	106.5	F	<b>174.6</b>	<b>F</b>	43.2	D	44.0	D
			SB	47.5	D	47.5	D	48.2	D	48.2	D
6	SH-172/CR 220		EB	12.3	B	12.8	B	11.5	B	11.6	B
			<b>WB</b>	<b>13.1</b>	<b>B</b>	<b>14.5</b>	<b>B</b>	<b>13.5</b>	<b>B</b>	<b>14.2</b>	<b>B</b>
			NB	0.3	A	0.3	A	0.5	A	0.4	A
			SB	0.5	A	0.5	A	0.6	A	0.7	A

**Table 6.11: Intersection Performance with CR-220 Closure (Winter Counts)**

ID	Intersection	Control	Approach	AM		AM (Detour)		PM		PM (Detour)	
				Delay	LOS	Delay	LOS	Delay	LOS	Delay	LOS
4	US-160 / Three Springs Blvd	Signal	<b>Overall</b>	<b>27.6</b>	<b>C</b>	<b>34.2</b>	<b>C</b>	<b>16.4</b>	<b>B</b>	<b>16.3</b>	<b>B</b>
			EB	22.5	C	22.5	B	12.9	B	12.9	B
			WB	29.1	C	39.3	D	12.6	B	12.8	B
			NB	45.4	D	45.4	D	46.1	D	46.1	D
			SB	44.6	D	44.6	D	48.2	D	48.2	D
5	US-160 / SH-172	Signal	<b>Overall</b>	<b>34.7</b>	<b>C</b>	<b>54.0</b>	<b>D</b>	<b>20.8</b>	<b>C</b>	<b>22.0</b>	<b>C</b>
			EB	20	C	20	C	11.6	B	12.4	B
			WB	20.3	C	20.3	C	16.9	B	17.7	B
			NB	63.8	E	115.7	F	42.8	D	43.1	D
			SB	47.9	D	47.9	D	48.5	D	48.5	D
6	SH-172/CR 220		EB	12.2	B	12.8	B	11	B	11	B
			<b>WB</b>	<b>13.2</b>	<b>B</b>	<b>14.2</b>	<b>B</b>	<b>12.2</b>	<b>B</b>	<b>12.7</b>	<b>B</b>
			NB	0.3	A	0.3	A	0.4	A	0.4	A
			SB	0.5	A	0.5	A	0.6	A	0.6	A

As shown in **Table 6.10 and 6.11**, the intersection LOS is not maintained at LOS D or better overall at all intersections during summer peak. Also, during the winter peak, the NB approach at US-160 / SU-172 is LOS F for AM peak hour. No significant change in queuing was observed due to the detour. This closure does not meet mobility thresholds.

### 6.3.5 ONE-LANE / TWO-WAY OPERATIONS ON US-550

An analysis of one-lane / two-way operations on US-550 was completed to evaluate if this strategy would meet mobility thresholds. This strategy would restrict US-550 to a single lane and then implement reversible traffic flow on the lane. There are two approaches to implementing this kind of lane restriction that would vary in impacts to the traveling public:

1. A short distance operation that could be controlled by flaggers and/or temporary signal equipment
2. A longer distance operation that would be controlled using flaggers and a pilot vehicle.



The first operation would consist of a shorter “cycle” and a shorter “clearance interval” to clear out one direction of traffic to prepare for the other. For the second operation, it would consist of a longer “cycle” and a longer “clearance interval” to clear out traffic and get the pilot car turned around. As these two operations vary greatly, both were analyzed independently of each other.

**Short Distance Operation**

For the short distance operation, the following assumptions were used:

- Traffic would cycle every 5 minutes (both directions would be served every 5 minutes)
- There would be a 45 second clearance interval to allow for a transition between serving northbound and southbound traffic. This should allow enough time for traffic to travel approx. 2,000 feet at a reduced speed of 35 mph through the one-lane section with a 5 second buffer.

This condition was analyzed using Synchro (HCM 2000) for delay, and a Poisson calculation for queueing. The Poisson calculation was determined based on the following formula:

$$Q = 25 * (N + z\sqrt{N})$$

Where:

- Q= Queue Length (ft)
- N = Number of Vehicles per cycle
- Z= 1.645 for a 95% confidence level

Given these assumptions, Table 6.12 shows the expected performance of this system.

**Table 6.12 Short Distance Results**

Location	Time Period	Delay (sec)	Longest Queue (ft)
US 550: Between US-160 and CR-220	Summer AM	80	1680
	Summer PM	88	1510
	Winter AM	74	1450
	Winter PM	81	1310
US 550: South of CR-220	Summer AM	73	1410
	Summer PM	81	1310
	Winter AM	70	1260
	Winter PM	77	1130

As shown in Table 6.12, both locations experience delays within the 20 minute threshold allowed. Queueing extends between 1130’ and 1680’ depending on the location/time of year. The queueing metric of fitting

within storage lengths would not be applicable in this situation, nor would LOS criteria. Based on these results, it is recommended to allow short distance one-lane/two-way operations during peak periods as the defined mobility threshold (travel time) is met and the other two mobility thresholds do not apply.

Given that the short distance results meet thresholds for all scenarios, it was determined that the long distance alternative should be evaluated for the "best case" condition to determine if it is feasible under the lowest traffic volumes, are the traffic volumes between south of CR-220 for the Winter AM condition. For the long distance evaluation, the following assumptions were used:

- The lane restriction would be in effect for the entire length of the project (20,000 ft)
- Traffic would travel at 35 mph behind a pilot vehicle, resulting in a one-way trip that would take 6.5 minutes to complete
- It would take 7 minutes for the pilot car to turn around and return
- The resulting "cycle length" is 20 minutes, with 10 minutes of "green time" allowed for each direction, and an "all red" time of 400 seconds for each direction to allow the area to clear.

Due to limitations of the methodology in estimating delay for such oversaturated conditions, SimTraffic was used to evaluate this scenario. Delay was estimated to be 19 minutes for the worst approach (NBT) which is very close to exceeding the 20 minute threshold, and should be considered to exceed the threshold. It certainly will for other scenarios with higher volumes. Additionally, this scenario would result in a queue of 5,350 feet, or just over a mile. While the definition of the queueing mobility threshold (fits within existing storage) is not applicable in this situation, this length of queue would be considered excessive and should not be allowed. Since this closure exceeded mobility thresholds for the "best" case no additional analysis of the other time periods or locations was completed. It is recommended that long distance lane closures be disallowed by the contract

## 7.0 OPTIONAL APPROACHES

The analyses outlined in this report are intended to give CDOT a basis of understanding of mobility opportunities and constraints associated with this major construction project. The analysis has been based on a proposed construction phasing approach in order to demonstrate that the project could be built within the identified mobility thresholds.

CDOT has a couple of fundamental choices on how to apply this information moving forward. The first option is to turn these recommendations into formal, prescriptive provisions that the contracting team must abide by. This path could make the project easier for all involved since there is less latitude for “stepping outside the box”. The contractor and owner can focus on other resource-saving options instead of maintenance of traffic.

The other choice is for CDOT to use the information from this report as a foundation, or starting point, for MOT and staging. The contractor could be given the latitude to develop his own construction approach that also fits within the identified mobility thresholds. The burden of proof to demonstrate that the bidders approach meets mobility thresholds would be placed on the proposing team. This option provides an opportunity for greater creativity on behalf of the contracting team and ideally, could provide the most benefit to the traveling public.

Based on conversations with the team, it has been determined that the contractual requirements for MOT on this project will generally follow the first approach. That is to say that lane closures will be formally allowed or restricted by the contract. If the contractors wish to deviate from the formal requirements, they will be required to submit an ATC to do so. The requirements could be provided using the information in **Table 1.1.**

## 8.0 MONITORING DURING CONSTRUCTION

It is recommended that CDOT include requirements for the contractor to monitor traffic congestion during construction and adjust lane closure strategies as needed to deal with unexpected circumstances. Monitoring can be accomplished by the contractor through use of a combination of any of the following concepts:

- A regularly scheduled meeting with all parties involved to discuss challenges and successes. This meeting should include representatives from CDOT including traffic and maintenance, the contractor, law enforcement, public outreach, incident management team, school district, impacted tribes, City representatives, and others as deemed necessary by CDOT.
- Providing a bi-weekly or monthly mobility report to the team outlining which construction occurred over the past month, report on mobility metrics, and provide an overview of upcoming construction activities that are planned or on-going.
- Floating-Car Travel Time measurements and queue surveys to evaluate compliance with the mobility thresholds.
- Use of newer technologies, such as gathering Bluetooth or cellphone data to evaluate compliance with mobility thresholds.
- Evaluation of any significant crashes or accidents or reoccurring accidents that occur within the area impacted by construction.
- Regularly held public surveys evaluating the perception of the public on construction delays
- Monitoring by CDOT supervisors and inspectors to report any unexpected traffic congestion to contractor and work through modifications to traffic control devices to mitigate congestion.

Monitoring compliance with the mobility thresholds is effective for increases to travel time as well as queueing, but is more difficult for LOS as this metric is difficult to measure in the field.

For many of these elements, such as travel time or public surveys, it is important that a “baseline” condition be established before construction activities begin to establish a control point to compare against. At a bare minimum, the contractor should be required to:

- Monitor compliance with the mobility thresholds for travel time and queueing.
- Regularly report measured compliance with mobility thresholds to CDOT.
- Coordinate with all effected parties (as outlined above).
- Establish a Transportation Management Plan (TMP) that outlines:
  - A summary of expected lane closures that complies with the requirements of the contract.
  - A plan for contingency and emergencies.
  - A Decision Tree including contact information for key personnel at CDOT and for the contractor.

## 9.0 RECOMMENDATIONS

The analysis results are compiled in **Table 8.1**, along with a recommendation of which closures evaluated should be allowed.

**Table 8.1: Analysis Summary and Recommendation**

Analyzed Closure	Summer Volume Impacted (Veh / Day)	Meets Threshold in Summer?			Meets Threshold in Winter?			Recommended	
		LOS	Travel Time	Queue	LOS	Travel Time	Queue	Summer	Winter
Long-Term Full Closure of Ramp B	600	Yes	Yes	Yes	Yes	Yes	Yes	Yes	Yes
Long-Term WB Lane Closure on US-160	10,400	Yes	N/A	Yes	Yes	N/A	Yes	No <sup>1</sup>	No <sup>1</sup>
Long-Term EB Lane Closure on US-160	10,400	No	N/A	No	No	N/A	No	No	No
Long-Term Full Closure on US-550	8,900	No	Yes	No	No	Yes	No	No	No
Long-Term Full Closure on CR-220	1,300	No	Yes	Yes	No	Yes	Yes	No	No
Short Distance One-Lane Two-Way Operations on US-550	8,900	N/A	Yes	Yes	N/A	Yes	Yes	Yes	Yes
Long Distance One-Lane Two-Way Operations on US-550	8,900	N/A	No	No	N/A	No	No	No	No

1. Although this closure meets mobility thresholds, it is not recommended based on the impact that would be created for such a large volume of traffic.
2. This closure could be allowed if the distance of the restriction is limited to 500' or less.

As described in Section 5.3, short-term closures should be limited to between 7 PM and 7 AM.



## Appendix A: Traffic Counts



(303) 216-2439  
www.alltrafficdata.net

**Location:** 1 US-550 & US-160 AM  
**Date:** Thursday, September 27, 2018  
**Peak Hour:** 07:30 AM - 08:30 AM  
**Peak 15-Minutes:** 07:45 AM - 08:00 AM

**Peak Hour - All Vehicles**

**Peak Hour - Pedestrians/Bicycles on Crosswalk**

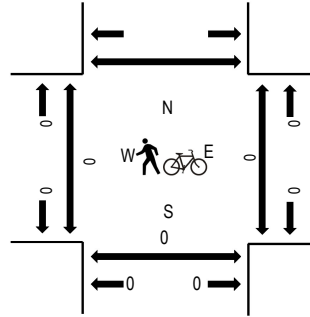
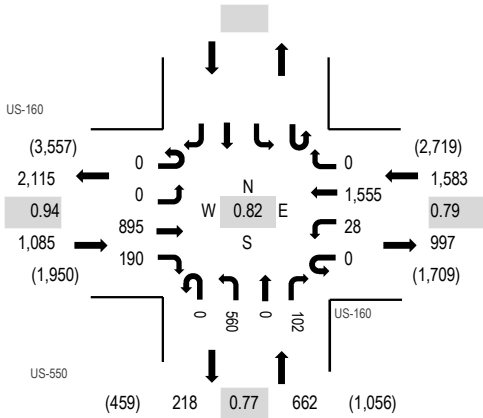

Note: Total study counts contained in parentheses.

**Traffic Counts**

Interval Start Time	US-160 Eastbound				US-160 Westbound				US-550 Northbound				US-550 Southbound				Total	Rolling Hour	Pedestrian Crossings			
	U-Turn	Left	Thru	Right	U-Turn	Left	Thru	Right	U-Turn	Left	Thru	Right	U-Turn	Left	Thru	Right			West	East	South	North
7:00 AM	0	0	143	55	0	10	254	0	0	0	69	0	13	0	0	0	0	544	3,136	0	0	0
7:15 AM	0	0	152	47	0	5	329	0	0	0	105	0	21	0	0	0	0	659	3,304	0	0	0
7:30 AM	0	0	182	44	0	4	484	0	0	0	174	0	26	0	0	0	0	914	3,330	0	0	0
7:45 AM	0	0	247	37	0	4	513	0	0	0	185	0	33	0	0	0	0	1,019	2,990	0	0	0
8:00 AM	0	0	233	53	0	16	284	0	0	0	101	0	25	0	0	0	0	712	2,589	0	0	0
8:15 AM	0	0	233	56	0	4	274	0	0	0	100	0	18	0	0	0	0	685		0	0	0
8:30 AM	0	0	167	53	0	5	254	0	0	0	85	0	10	0	0	0	0	574		0	0	0
8:45 AM	0	0	195	53	0	13	266	0	0	0	80	0	11	0	0	0	0	618		0	0	0
Count Total	0	0	1,552	398	0	61	2,658	0	0	0	899	0	157	0	0	0	0	5,725		0	0	0
Peak Hour	0	0	895	190	0	28	1,555	0	0	0	560	0	102	0	0	0	0	3,330		0	0	0



(303) 216-2439  
www.alltrafficdata.net

Location: 2 US-550 & CO RD 220 AM

Date: Thursday, September 27, 2018

Peak Hour: 07:15 AM - 08:15 AM

Peak 15-Minutes: 07:30 AM - 07:45 AM

**Peak Hour - All Vehicles**

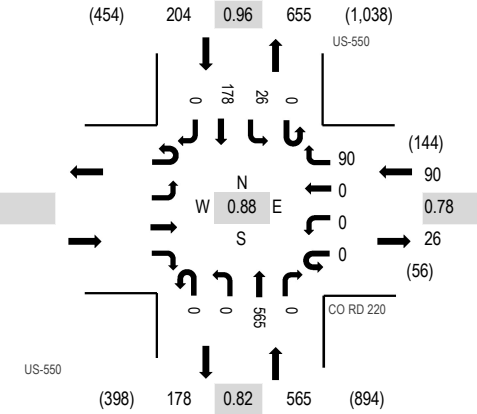

Note: Total study counts contained in parentheses.

**Peak Hour - Pedestrians/Bicycles on Crosswalk**

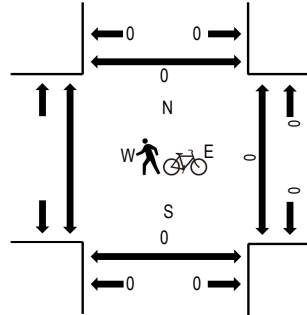

**Traffic Counts**

Interval Start Time	CO RD 220 Westbound				US-550 Northbound				US-550 Southbound				Total	Rolling Hour	Pedestrian Crossings							
	U-Turn	Left	Thru	Right	U-Turn	Left	Thru	Right	U-Turn	Left	Thru	Right			West	East	South	North				
7:00 AM					0	0	0	15	0	0	73	0	0	0	3	59	0	150	827	0	0	0
7:15 AM					0	0	0	24	0	0	121	0	0	0	5	52	0	202	859	0	0	0
7:30 AM					0	0	0	29	0	0	173	0	0	0	6	36	0	244	836	0	0	0
7:45 AM					0	0	0	22	0	0	169	0	0	0	5	35	0	231	744	0	0	0
8:00 AM					0	0	0	15	0	0	102	0	0	0	10	55	0	182	665	0	0	0
8:15 AM					0	0	0	13	0	0	102	0	0	0	7	57	0	179		0	0	0
8:30 AM					0	0	0	13	0	0	81	0	0	0	5	53	0	152		0	0	0
8:45 AM					0	0	0	13	0	0	73	0	0	0	15	51	0	152		0	0	0
Count Total					0	0	0	144	0	0	894	0	0	0	56	398	0	1,492		0	0	0
Peak Hour					0	0	0	90	0	0	565	0	0	0	26	178	0	859		0	0	0



(303) 216-2439  
www.alltrafficdata.net

Location: 3 WILSON GULCH DR & US-160 WB RAMPS AM

Date: Thursday, September 27, 2018

Peak Hour: 07:30 AM - 08:30 AM

Peak 15-Minutes: 07:45 AM - 08:00 AM

**Peak Hour - All Vehicles**

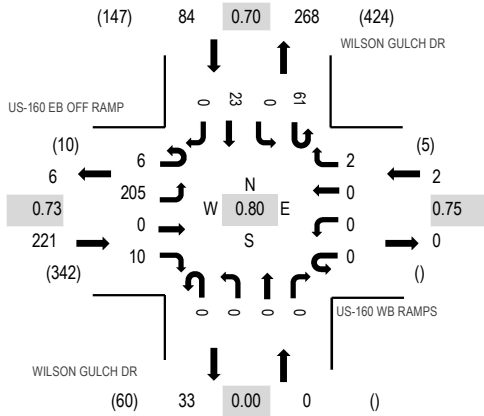

Note: Total study counts contained in parentheses.

**Peak Hour - Pedestrians/Bicycles on Crosswalk**

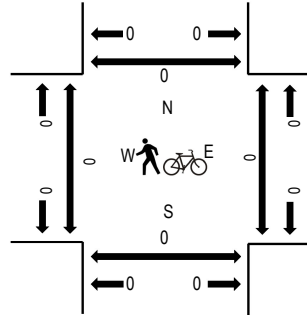

**Traffic Counts**

Interval Start Time	US-160 EB OFF RAMP Eastbound				US-160 WB RAMPS Westbound				WILSON GULCH DR Northbound				WILSON GULCH DR Southbound				Total	Rolling Hour	Pedestrian Crossings			
	U-Turn	Left	Thru	Right	U-Turn	Left	Thru	Right	U-Turn	Left	Thru	Right	U-Turn	Left	Thru	Right			West	East	South	North
7:00 AM	2	26	0	0	0	0	0	0	0	0	0	0	12	0	4	0	44	259	0	0	0	0
7:15 AM	0	35	0	3	0	0	0	1	0	0	0	0	9	0	3	0	51	298	0	0	0	0
7:30 AM	2	33	0	2	0	0	0	1	0	0	0	0	21	0	9	0	68	307	0	0	0	0
7:45 AM	2	72	0	2	0	0	0	0	0	0	0	0	15	0	5	0	96	279	0	0	0	0
8:00 AM	1	58	0	4	0	0	0	0	0	0	0	0	14	0	6	0	83	235	0	0	0	0
8:15 AM	1	42	0	2	0	0	0	1	0	0	0	0	11	0	3	0	60		0	0	0	0
8:30 AM	1	20	0	3	0	0	0	1	0	0	0	0	11	0	4	0	40		0	0	0	0
8:45 AM	1	28	0	2	0	1	0	0	0	0	0	0	13	0	7	0	52		0	0	0	0
Count Total	10	314	0	18	0	1	0	4	0	0	0	0	106	0	41	0	494		0	0	0	0
Peak Hour	6	205	0	10	0	0	0	2	0	0	0	0	61	0	23	0	307		0	0	0	0





(303) 216-2439  
www.alltrafficdata.net

**Location:** 1 US-550 & US-160 PM  
**Date:** Thursday, September 27, 2018  
**Peak Hour:** 04:30 PM - 05:30 PM  
**Peak 15-Minutes:** 05:00 PM - 05:15 PM

**Peak Hour - All Vehicles**

**Peak Hour - Pedestrians/Bicycles on Crosswalk**

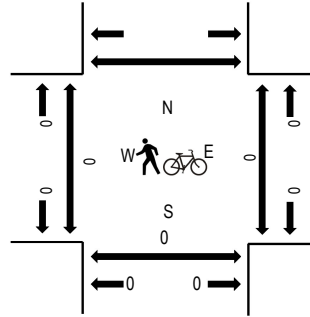
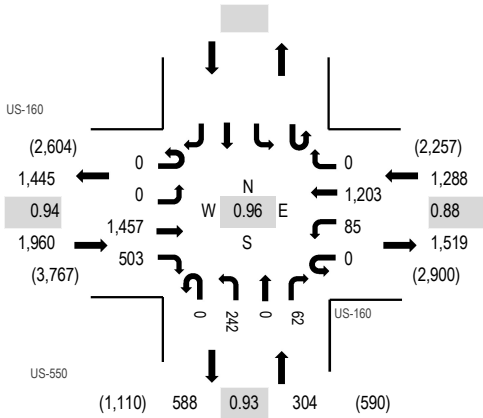

Note: Total study counts contained in parentheses.

**Traffic Counts**

Interval Start Time	US-160 Eastbound				US-160 Westbound				US-550 Northbound				US-550 Southbound				Total	Rolling Hour	Pedestrian Crossings			
	U-Turn	Left	Thru	Right	U-Turn	Left	Thru	Right	U-Turn	Left	Thru	Right	U-Turn	Left	Thru	Right			West	East	South	North
4:00 PM	0	0	353	109	0	6	264	0	0	0	65	0	10	0	0	0	0	807	3,333	0	0	0
4:15 PM	0	0	324	115	0	21	280	0	0	0	59	0	13	0	0	0	0	812	3,451	0	0	0
4:30 PM	0	0	352	134	0	17	307	0	0	0	65	0	19	0	0	0	0	894	3,552	0	0	0
4:45 PM	0	0	363	99	0	23	254	0	0	0	68	0	13	0	0	0	0	820	3,436	0	0	0
5:00 PM	0	0	369	123	0	28	336	0	0	0	56	0	13	0	0	0	0	925	3,281	0	0	0
5:15 PM	0	0	373	147	0	17	306	0	0	0	53	0	17	0	0	0	0	913		0	0	0
5:30 PM	0	0	365	123	0	17	197	0	0	0	69	0	7	0	0	0	0	778		0	0	0
5:45 PM	0	0	296	122	0	9	175	0	0	0	50	0	13	0	0	0	0	665		0	0	0
Count Total	0	0	2,795	972	0	138	2,119	0	0	0	485	0	105					6,614		0	0	0
Peak Hour	0	0	1,457	503	0	85	1,203	0	0	0	242	0	62					3,552		0	0	0



(303) 216-2439  
www.alltrafficdata.net

Location: 2 US-550 & CO RD 220 PM

Date: Thursday, September 27, 2018

Peak Hour: 04:30 PM - 05:30 PM

Peak 15-Minutes: 05:15 PM - 05:30 PM

### Peak Hour - All Vehicles

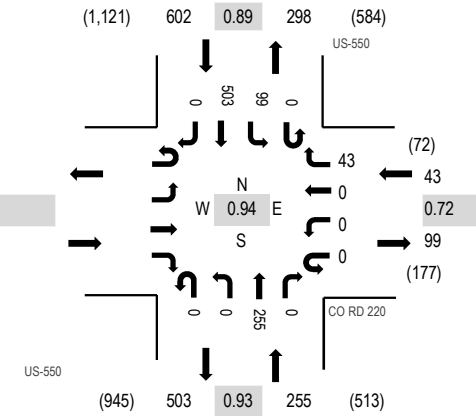

Note: Total study counts contained in parentheses.

### Peak Hour - Pedestrians/Bicycles on Crosswalk

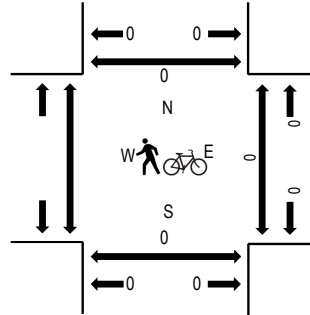

### Traffic Counts

Interval Start Time	CO RD 220				US-550				US-550				Total	Rolling Hour	Pedestrian Crossings							
	Westbound				Northbound				Southbound						West	East	South	North				
	U-Turn	Left	Thru	Right	U-Turn	Left	Thru	Right	U-Turn	Left	Thru	Right										
4:00 PM					0	0	0	9	0	0	63	0	0	0	13	98	0	183	828	0	0	0
4:15 PM					0	0	0	8	0	0	66	0	0	0	23	106	0	203	864	0	0	0
4:30 PM					0	0	0	9	0	0	71	0	0	0	27	125	0	232	900	0	0	0
4:45 PM					0	0	0	15	0	0	64	0	0	0	21	110	0	210	895	0	0	0
5:00 PM					0	0	0	9	0	0	60	0	0	0	22	128	0	219	878	0	0	0
5:15 PM					0	0	0	10	0	0	60	0	0	0	29	140	0	239		0	0	0
5:30 PM					0	0	0	7	0	0	78	1	0	0	22	119	0	227		0	0	0
5:45 PM					0	0	0	5	0	0	50	0	0	0	19	119	0	193		0	0	0
Count Total					0	0	0	72	0	0	512	1	0	0	176	945	0	1,706		0	0	0
Peak Hour					0	0	0	43	0	0	255	0	0	0	99	503	0	900		0	0	0





(303) 216-2439  
www.alltrafficdata.net

**Location:** 1 SH 172 & CR 221 AM  
**Date:** Thursday, December 6, 2018  
**Peak Hour:** 07:15 AM - 08:15 AM  
**Peak 15-Minutes:** 07:30 AM - 07:45 AM

**Peak Hour - All Vehicles**

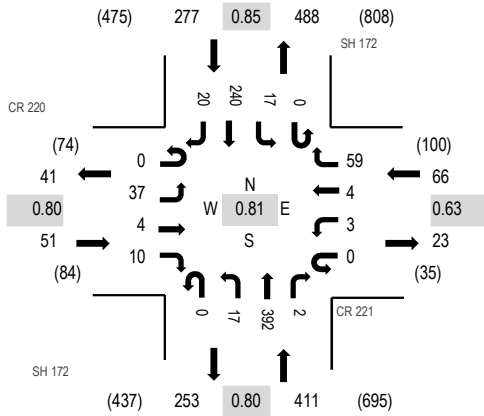

**Peak Hour - Pedestrians/Bicycles on Crosswalk**

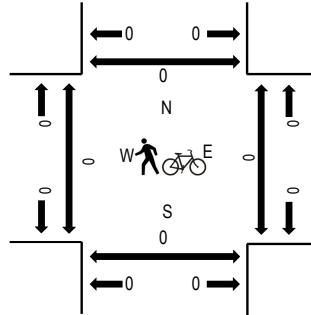

Note: Total study counts contained in parentheses.

**Traffic Counts**

Interval Start Time	CR 220 Eastbound				CR 221 Westbound				SH 172 Northbound			SH 172 Southbound				Total	Rolling Hour	Pedestrian Crossings				
	U-Turn	Left	Thru	Right	U-Turn	Left	Thru	Right	U-Turn	Left	Thru	Right	U-Turn	Left	Thru			Right	West	East	South	North
7:00 AM	0	5	1	1	0	0	2	13	0	1	62	2	0	1	42	5	135	798	0	0	0	0
7:15 AM	0	11	3	2	0	2	0	17	0	5	105	1	0	5	59	4	214	805	0	0	0	0
7:30 AM	0	14	0	1	0	1	3	24	0	5	124	0	0	4	64	7	247	732	0	0	0	0
7:45 AM	0	7	1	3	0	0	0	9	0	1	100	0	0	3	72	6	202	629	0	0	0	0
8:00 AM	0	5	0	4	0	0	1	9	0	6	63	1	0	5	45	3	142	556	0	0	0	0
8:15 AM	0	4	1	1	0	1	0	7	0	3	71	0	0	0	50	3	141		0	0	0	0
8:30 AM	0	9	2	4	0	0	3	4	0	3	73	1	0	1	39	5	144		0	0	0	0
8:45 AM	0	5	0	0	0	1	1	2	0	2	65	1	0	2	45	5	129		0	0	0	0
Count Total	0	60	8	16	0	5	10	85	0	26	663	6	0	21	416	38	1,354		0	0	0	0
Peak Hour	0	37	4	10	0	3	4	59	0	17	392	2	0	17	240	20	805		0	0	0	0





(303) 216-2439  
www.alltrafficdata.net

**Location:** 1 SH 172 & CR 221 PM  
**Date:** Thursday, December 6, 2018  
**Peak Hour:** 04:30 PM - 05:30 PM  
**Peak 15-Minutes:** 04:30 PM - 04:45 PM

**Peak Hour - All Vehicles**

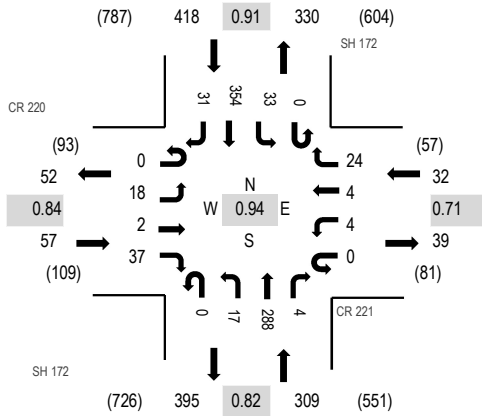

Note: Total study counts contained in parentheses.

**Peak Hour - Pedestrians/Bicycles on Crosswalk**

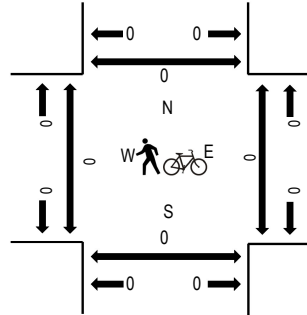

**Traffic Counts**

Interval Start Time	CR 220 Eastbound				CR 221 Westbound				SH 172 Northbound			SH 172 Southbound				Total	Rolling Hour	Pedestrian Crossings				
	U-Turn	Left	Thru	Right	U-Turn	Left	Thru	Right	U-Turn	Left	Thru	Right	U-Turn	Left	Thru			Right	West	East	South	North
4:00 PM	0	4	5	7	0	0	1	6	0	3	47	0	0	7	79	8	167	768	0	0	0	0
4:15 PM	0	5	3	3	0	1	0	1	0	5	68	0	0	10	87	8	191	790	0	0	0	0
4:30 PM	0	6	2	9	0	1	1	7	0	8	74	2	0	9	92	6	217	816	0	0	0	0
4:45 PM	0	6	0	7	0	1	1	3	0	5	76	1	0	7	76	10	193	771	0	0	0	0
5:00 PM	0	3	0	10	0	1	1	10	0	2	46	1	0	8	100	7	189	736	0	0	0	0
5:15 PM	0	3	0	11	0	1	1	4	0	2	92	0	0	9	86	8	217		0	0	0	0
5:30 PM	0	7	2	4	0	1	1	4	0	3	68	0	0	11	66	5	172		0	0	0	0
5:45 PM	0	9	0	3	0	1	0	9	0	2	46	0	0	4	79	5	158		0	0	0	0
Count Total	0	43	12	54	0	7	6	44	0	30	517	4	0	65	665	57	1,504		0	0	0	0
Peak Hour	0	18	2	37	0	4	4	24	0	17	288	4	0	33	354	31	816		0	0	0	0

**All Traffic Data Services**  
www.alltrafficdata.net

Site Code: 4  
Station ID:  
US-160 W/O US-550

EB

Start Time	Bikes	Cars & Trailers	2 Axle Long	Buses	2 Axle 6 Tire	3 Axle Single	4 Axle Single	<5 Axl Double	5 Axle Double	>6 Axl Double	<6 Axl Multi	6 Axle Multi	>6 Axl Multi	Total
09/27/18	1	37	3	1	1	0	0	0	0	0	0	0	0	43
01:00	0	23	4	0	0	0	0	0	1	0	0	0	0	28
02:00	1	19	3	0	1	0	0	0	2	0	0	0	0	26
03:00	0	18	1	0	1	1	0	2	2	0	0	0	0	25
04:00	1	54	5	0	1	1	0	2	4	0	0	0	0	68
05:00	2	165	11	0	0	3	0	1	4	0	0	0	0	186
06:00	10	340	46	2	8	4	0	5	11	0	0	1	0	427
07:00	35	431	97	7	12	17	7	9	13	2	1	0	6	637
08:00	35	650	133	7	11	29	4	11	11	2	5	0	4	902
09:00	38	574	122	2	19	15	11	13	12	0	3	1	6	816
10:00	27	609	124	10	15	20	5	17	14	1	1	1	4	848
11:00	38	664	133	3	11	15	5	9	11	1	4	0	3	897
12 PM	29	717	151	8	9	25	9	7	15	1	2	0	6	979
13:00	30	778	135	7	15	19	8	15	17	1	3	1	6	1035
14:00	47	832	149	10	10	29	12	7	8	1	2	2	11	1120
15:00	46	858	169	16	15	24	10	18	15	1	4	0	5	1181
16:00	52	1153	234	15	14	21	10	27	16	3	1	1	6	1553
17:00	56	1278	202	5	7	30	18	22	11	2	1	1	9	1642
18:00	49	887	162	1	8	14	9	14	5	1	0	1	3	1154
19:00	30	681	104	2	6	11	8	10	5	0	0	0	1	858
20:00	7	447	56	0	2	3	2	4	4	0	0	0	1	526
21:00	2	315	23	0	0	0	1	0	1	0	0	0	0	342
22:00	4	182	13	0	1	1	0	0	1	0	0	0	0	202
23:00	0	102	4	0	1	0	1	1	3	0	0	0	0	112
Day Total	540	11814	2084	96	168	282	120	194	186	16	27	9	71	15607
Percent	3.5%	75.7%	13.4%	0.6%	1.1%	1.8%	0.8%	1.2%	1.2%	0.1%	0.2%	0.1%	0.5%	
AM Peak	09:00	11:00	08:00	10:00	09:00	08:00	09:00	10:00	10:00	07:00	08:00	06:00	07:00	08:00
Vol.	38	664	133	10	19	29	11	17	14	2	5	1	6	902
PM Peak	17:00	17:00	16:00	15:00	13:00	17:00	17:00	16:00	13:00	16:00	15:00	14:00	14:00	17:00
Vol.	56	1278	234	16	15	30	18	27	17	3	4	2	11	1642

**All Traffic Data Services**  
www.alltrafficdata.net

Site Code: 4  
Station ID:  
US-160 W/O US-550

**EB**

Start Time	Bikes	Cars & Trailers	2 Axle Long	Buses	2 Axle 6 Tire	3 Axle Single	4 Axle Single	<5 Axl Double	5 Axle Double	>6 Axl Double	<6 Axl Multi	6 Axle Multi	>6 Axl Multi	Total
09/28/18	0	46	3	0	1	0	0	0	0	0	0	0	0	50
01:00	0	33	2	0	1	0	0	0	2	0	0	0	0	38
02:00	0	33	1	0	0	0	0	0	1	0	0	0	0	35
03:00	1	22	2	0	1	0	0	0	4	0	0	0	0	30
04:00	0	66	2	0	1	1	0	0	5	0	0	0	0	75
05:00	2	152	11	0	2	2	0	0	5	0	0	0	1	175
06:00	10	249	56	0	11	10	1	7	12	0	0	0	1	357
07:00	37	461	68	<b>8</b>	9	16	<b>9</b>	8	8	1	0	0	1	626
08:00	33	634	108	4	12	13	7	<b>15</b>	8	<b>2</b>	1	<b>1</b>	4	842
09:00	30	608	130	5	<b>14</b>	22	7	13	11	0	<b>3</b>	1	4	848
10:00	<b>38</b>	662	125	7	11	15	8	7	15	2	2	0	<b>5</b>	897
11:00	38	<b>766</b>	<b>137</b>	2	14	<b>23</b>	9	13	<b>16</b>	1	1	0	1	<b>1021</b>
12 PM	38	811	133	12	8	24	10	16	<b>16</b>	1	1	1	4	1075
13:00	30	864	160	5	9	25	10	16	9	<b>3</b>	1	<b>2</b>	4	1138
14:00	42	880	132	4	12	19	6	20	12	2	<b>3</b>	0	5	1137
15:00	49	965	168	8	<b>15</b>	21	6	15	16	1	0	0	7	1271
16:00	<b>52</b>	<b>1166</b>	187	10	9	<b>29</b>	14	<b>24</b>	11	0	3	2	<b>9</b>	<b>1516</b>
17:00	51	1161	<b>204</b>	<b>17</b>	11	22	<b>15</b>	18	8	1	2	0	5	1515
18:00	37	843	131	11	8	20	10	16	3	0	1	0	4	1084
19:00	22	665	99	1	2	13	5	4	2	1	2	0	0	816
20:00	6	532	67	0	2	6	1	1	1	0	0	0	1	617
21:00	6	359	32	0	1	0	0	3	1	0	0	0	0	402
22:00	4	279	22	0	1	1	3	1	4	0	0	0	1	316
23:00	3	167	11	0	3	0	0	0	2	0	0	0	0	186
Day Total	529	12424	1991	94	158	282	121	197	172	15	20	7	57	16067
Percent	3.3%	77.3%	12.4%	0.6%	1.0%	1.8%	0.8%	1.2%	1.1%	0.1%	0.1%	0.0%	0.4%	
AM Peak	10:00	11:00	11:00	07:00	09:00	11:00	07:00	08:00	11:00	08:00	09:00	08:00	10:00	11:00
Vol.	38	766	137	8	14	23	9	15	16	2	3	1	5	1021
PM Peak	16:00	16:00	17:00	17:00	15:00	16:00	17:00	16:00	12:00	13:00	14:00	13:00	16:00	16:00
Vol.	52	1166	204	17	15	29	15	24	16	3	3	2	9	1516

**All Traffic Data Services**  
www.alltrafficdata.net

Site Code: 4  
Station ID:  
US-160 W/O US-550

**EB**

Start Time	Bikes	Cars & Trailers	2 Axle Long	Buses	2 Axle 6 Tire	3 Axle Single	4 Axle Single	<5 Axl Double	5 Axle Double	>6 Axl Double	<6 Axl Multi	6 Axle Multi	>6 Axl Multi	Total
09/29/18	0	80	4	1	0	0	0	0	1	0	0	0	0	86
01:00	1	54	4	0	0	0	0	1	0	0	0	0	0	60
02:00	1	53	5	0	1	0	0	1	1	0	0	0	0	62
03:00	1	31	5	0	1	0	0	0	2	0	0	0	0	40
04:00	1	72	4	0	0	0	0	0	6	0	0	0	0	83
05:00	0	85	7	0	2	1	0	0	0	0	0	0	0	95
06:00	1	169	15	0	1	1	0	2	4	0	0	0	0	193
07:00	10	233	29	2	5	2	0	1	2	0	0	0	1	285
08:00	21	413	56	0	5	4	2	3	3	1	0	0	2	510
09:00	25	502	94	2	5	9	4	9	2	0	4	0	2	658
10:00	<b>30</b>	583	107	<b>7</b>	<b>9</b>	<b>11</b>	<b>10</b>	<b>15</b>	<b>10</b>	0	2	1	0	785
11:00	24	<b>722</b>	<b>131</b>	5	6	9	2	6	6	0	3	0	0	<b>914</b>
12 PM	23	755	111	4	3	4	3	<b>12</b>	<b>9</b>	0	0	0	3	927
13:00	35	778	123	1	3	6	5	8	7	0	0	0	6	972
14:00	29	<b>802</b>	121	7	5	<b>17</b>	3	8	8	0	2	0	3	1005
15:00	34	741	113	6	<b>9</b>	17	8	9	8	<b>3</b>	1	0	5	954
16:00	<b>41</b>	797	<b>133</b>	<b>8</b>	3	16	10	8	7	0	0	1	2	<b>1026</b>
17:00	38	769	96	0	2	11	<b>11</b>	8	2	0	2	1	4	944
18:00	30	680	105	2	2	6	5	3	3	0	1	0	0	837
19:00	19	606	77	0	1	4	3	3	3	0	0	0	0	716
20:00	14	511	60	1	2	2	3	2	1	0	0	0	0	596
21:00	2	301	36	0	0	3	2	2	1	0	0	0	0	347
22:00	0	250	7	0	1	0	1	0	3	0	0	0	0	262
23:00	2	172	14	0	1	1	0	0	0	0	0	0	0	190
Day Total	382	10159	1457	46	67	124	72	101	89	4	15	3	28	12547
Percent	3.0%	81.0%	11.6%	0.4%	0.5%	1.0%	0.6%	0.8%	0.7%	0.0%	0.1%	0.0%	0.2%	
AM Peak	10:00	11:00	11:00	10:00	10:00	10:00	10:00	10:00	10:00	08:00	09:00	10:00	08:00	11:00
Vol.	30	722	131	7	9	11	10	15	10	1	4	1	2	914
PM Peak	16:00	14:00	16:00	16:00	15:00	14:00	17:00	12:00	12:00	15:00	14:00	16:00	13:00	16:00
Vol.	41	802	133	8	9	17	11	12	9	3	2	1	6	1026



**All Traffic Data Services**  
www.alltrafficdata.net

Site Code: 4  
Station ID:  
US-160 W/O US-550

**EB**

Start Time	Bikes	Cars & Trailers	2 Axle Long	Buses	2 Axle 6 Tire	3 Axle Single	4 Axle Single	<5 Axl Double	5 Axle Double	>6 Axl Double	<6 Axl Multi	6 Axle Multi	>6 Axl Multi	Total
09/30/18	0	80	4	0	1	1	0	0	0	0	0	0	0	86
01:00	2	67	10	0	1	0	0	0	0	0	0	0	0	80
02:00	0	60	3	0	0	0	0	0	1	0	0	0	0	64
03:00	0	26	4	0	0	0	0	0	0	0	0	0	0	30
04:00	0	36	3	0	1	0	0	0	1	0	0	0	0	41
05:00	1	98	7	0	0	0	0	0	0	0	0	0	0	106
06:00	4	118	12	0	0	2	0	0	3	0	0	0	0	139
07:00	3	175	17	0	2	2	0	1	3	0	0	0	0	203
08:00	15	326	44	1	2	1	2	4	4	0	0	0	1	400
09:00	<b>25</b>	497	59	2	2	2	<b>5</b>	<b>11</b>	<b>10</b>	<b>1</b>	1	0	1	616
10:00	22	570	<b>75</b>	4	<b>5</b>	7	3	8	6	0	1	0	3	704
11:00	21	<b>681</b>	72	<b>5</b>	2	<b>8</b>	5	6	9	1	<b>2</b>	0	<b>4</b>	<b>816</b>
12 PM	22	708	81	3	1	8	4	9	10	0	0	0	1	847
13:00	37	702	100	<b>7</b>	4	13	<b>9</b>	8	<b>12</b>	0	0	0	3	895
14:00	34	<b>786</b>	99	4	<b>5</b>	12	5	<b>13</b>	7	<b>1</b>	<b>2</b>	0	<b>5</b>	<b>973</b>
15:00	<b>46</b>	731	108	3	0	12	3	5	7	0	1	0	1	917
16:00	30	728	105	6	0	<b>15</b>	7	11	2	0	1	<b>2</b>	2	909
17:00	40	705	<b>110</b>	1	4	6	5	10	5	1	1	0	0	888
18:00	21	624	97	1	1	5	8	12	7	1	2	0	4	783
19:00	17	493	83	0	5	5	4	5	2	0	0	0	1	615
20:00	7	338	58	1	2	4	0	2	1	0	1	0	0	414
21:00	6	203	32	0	1	1	0	1	1	0	0	0	1	246
22:00	2	130	8	0	0	0	0	0	0	0	0	0	1	141
23:00	0	83	4	0	0	0	0	0	1	0	0	0	0	88
Day Total	355	8965	1195	38	39	104	60	106	92	5	12	2	28	11001
Percent	3.2%	81.5%	10.9%	0.3%	0.4%	0.9%	0.5%	1.0%	0.8%	0.0%	0.1%	0.0%	0.3%	
AM Peak	09:00	11:00	10:00	11:00	10:00	11:00	09:00	09:00	09:00	09:00	11:00		11:00	11:00
Vol.	25	681	75	5	5	8	5	11	10	1	2		4	816
PM Peak	15:00	14:00	17:00	13:00	14:00	16:00	13:00	14:00	13:00	14:00	14:00	16:00	14:00	14:00
Vol.	46	786	110	7	5	15	9	13	12	1	2	2	5	973

**All Traffic Data Services**  
www.alltrafficdata.net

Site Code: 4  
Station ID:  
US-160 W/O US-550

**EB**

Start Time	Bikes	Cars & Trailers	2 Axle Long	Buses	2 Axle 6 Tire	3 Axle Single	4 Axle Single	<5 Axl Double	5 Axle Double	>6 Axl Double	<6 Axl Multi	6 Axle Multi	>6 Axl Multi	Total
10/01/18	0	30	1	0	1	0	0	1	0	0	0	0	0	33
01:00	0	21	2	0	0	0	0	0	1	0	0	0	0	24
02:00	0	14	1	0	0	0	0	0	1	0	0	0	0	16
03:00	0	27	2	0	1	0	0	0	1	0	0	0	0	31
04:00	0	65	3	0	2	0	0	0	5	0	0	0	0	75
05:00	2	127	15	0	1	2	0	1	2	0	0	0	0	150
06:00	6	356	41	0	7	7	3	9	9	0	0	0	0	438
07:00	24	516	67	3	4	18	<b>6</b>	8	14	1	1	<b>1</b>	2	665
08:00	30	627	127	<b>10</b>	11	17	6	9	6	0	0	0	3	846
09:00	32	655	124	4	7	16	6	<b>12</b>	9	0	<b>3</b>	0	4	872
10:00	<b>36</b>	653	122	7	11	22	3	11	<b>17</b>	<b>4</b>	1	1	1	889
11:00	24	<b>669</b>	<b>146</b>	6	<b>14</b>	<b>27</b>	3	10	13	0	0	1	<b>7</b>	<b>920</b>
12 PM	43	739	130	6	17	20	9	13	9	1	1	<b>1</b>	7	996
13:00	42	796	134	4	13	<b>26</b>	10	10	11	0	<b>4</b>	0	5	1055
14:00	45	867	175	15	<b>21</b>	26	10	11	16	1	0	0	7	1194
15:00	46	877	167	9	13	26	12	14	8	2	2	1	<b>10</b>	1187
16:00	<b>70</b>	1101	193	16	12	21	13	19	<b>19</b>	1	1	1	8	1475
17:00	43	<b>1229</b>	<b>216</b>	<b>19</b>	13	26	<b>15</b>	<b>27</b>	15	<b>3</b>	2	1	5	<b>1614</b>
18:00	21	903	138	0	5	12	8	5	5	0	2	0	3	1102
19:00	11	532	77	0	3	6	2	4	5	0	0	0	1	641
20:00	3	409	42	0	2	2	0	2	2	0	0	0	0	462
21:00	3	260	19	0	4	2	1	2	0	0	0	0	0	291
22:00	1	124	10	0	2	0	0	1	1	0	0	0	0	139
23:00	1	69	3	0	0	0	0	0	1	0	0	0	0	74
Day Total	483	11666	1955	99	164	276	107	169	170	13	17	7	63	15189
Percent	3.2%	76.8%	12.9%	0.7%	1.1%	1.8%	0.7%	1.1%	1.1%	0.1%	0.1%	0.0%	0.4%	
AM Peak	10:00	11:00	11:00	08:00	11:00	11:00	07:00	09:00	10:00	10:00	09:00	07:00	11:00	11:00
Vol.	36	669	146	10	14	27	6	12	17	4	3	1	7	920
PM Peak	16:00	17:00	17:00	17:00	14:00	13:00	17:00	17:00	16:00	17:00	13:00	12:00	15:00	17:00
Vol.	70	1229	216	19	21	26	15	27	19	3	4	1	10	1614

**All Traffic Data Services**  
www.alltrafficdata.net

Site Code: 4  
Station ID:  
US-160 W/O US-550

EB

Start Time	Bikes	Cars & Trailers	2 Axle Long	Buses	2 Axle 6 Tire	3 Axle Single	4 Axle Single	<5 Axl Double	5 Axle Double	>6 Axl Double	<6 Axl Multi	6 Axle Multi	>6 Axl Multi	Total
10/02/18	1	41	2	0	0	0	0	0	1	0	1	0	0	46
01:00	1	20	2	0	0	0	0	0	1	0	0	0	0	24
02:00	0	18	2	0	1	0	0	0	2	0	0	0	0	23
03:00	0	22	1	0	1	1	0	0	2	0	0	0	0	27
04:00	2	53	3	0	2	0	0	0	4	0	0	0	0	64
05:00	2	134	12	0	1	1	0	2	2	0	0	0	0	154
06:00	11	357	32	1	6	10	3	3	12	1	0	0	0	436
07:00	18	501	68	1	8	18	7	7	6	2	<b>2</b>	0	2	640
08:00	<b>39</b>	638	117	<b>7</b>	10	17	4	12	8	1	2	0	5	860
09:00	29	617	105	5	13	<b>21</b>	10	9	10	2	0	0	<b>6</b>	827
10:00	24	649	<b>130</b>	7	<b>14</b>	17	<b>12</b>	<b>14</b>	<b>14</b>	<b>4</b>	1	0	4	890
11:00	39	<b>703</b>	119	7	13	20	8	5	13	0	1	0	5	<b>933</b>
12 PM	26	785	138	4	<b>15</b>	22	6	6	9	1	<b>2</b>	0	5	1019
13:00	40	749	148	6	14	<b>26</b>	7	11	<b>18</b>	0	2	<b>2</b>	2	1025
14:00	29	912	148	3	13	16	7	13	13	1	0	0	5	1160
15:00	36	856	156	0	8	16	13	20	13	1	0	0	4	1123
16:00	41	1060	174	6	11	24	<b>15</b>	20	17	<b>2</b>	1	1	<b>6</b>	1378
17:00	<b>62</b>	<b>1363</b>	<b>250</b>	<b>20</b>	6	24	12	<b>23</b>	10	0	1	0	5	<b>1776</b>
18:00	34	882	92	2	3	12	7	7	8	0	0	0	1	1048
19:00	14	588	57	1	2	7	4	2	6	0	0	0	2	683
20:00	20	454	44	1	4	7	3	2	4	0	0	0	1	540
21:00	7	270	23	1	4	1	0	0	0	0	0	0	0	306
22:00	6	118	20	1	6	2	0	2	2	0	0	0	0	157
23:00	1	100	9	1	0	0	0	0	1	0	0	0	0	112
Day Total	482	11890	1852	74	155	262	118	158	176	15	13	3	53	15251
Percent	3.2%	78.0%	12.1%	0.5%	1.0%	1.7%	0.8%	1.0%	1.2%	0.1%	0.1%	0.0%	0.3%	
AM Peak	08:00	11:00	10:00	08:00	10:00	09:00	10:00	10:00	10:00	10:00	07:00		09:00	11:00
Vol.	39	703	130	7	14	21	12	14	14	4	2		6	933
PM Peak	17:00	17:00	17:00	17:00	12:00	13:00	16:00	17:00	13:00	16:00	12:00	13:00	16:00	17:00
Vol.	62	1363	250	20	15	26	15	23	18	2	2	2	6	1776

**All Traffic Data Services**  
www.alltrafficdata.net

Site Code: 4  
Station ID:  
US-160 W/O US-550

**EB**

Start Time	Bikes	Cars & Trailers	2 Axle Long	Buses	2 Axle 6 Tire	3 Axle Single	4 Axle Single	<5 Axl Double	5 Axle Double	>6 Axl Double	<6 Axl Multi	6 Axle Multi	>6 Axl Multi	Total
10/03/18	0	33	6	1	4	0	0	1	0	0	0	0	0	45
01:00	0	24	1	0	1	0	0	0	2	0	0	0	0	28
02:00	0	25	3	0	0	0	0	1	2	0	0	0	0	31
03:00	2	24	0	0	1	0	0	0	2	0	0	0	0	29
04:00	0	52	1	0	1	0	0	0	2	0	0	0	0	56
05:00	4	153	16	0	0	2	0	1	5	0	0	0	0	181
06:00	1	359	32	0	9	5	2	6	8	0	0	0	2	424
07:00	23	435	62	1	3	<b>22</b>	6	12	10	<b>2</b>	0	<b>1</b>	<b>3</b>	580
08:00	<b>26</b>	600	<b>121</b>	7	11	10	<b>7</b>	15	7	1	0	0	3	808
09:00	19	591	99	<b>8</b>	<b>18</b>	21	7	<b>16</b>	<b>14</b>	1	<b>3</b>	1	2	800
10:00	23	673	105	4	17	13	3	14	14	0	2	0	2	870
11:00	24	<b>689</b>	106	2	7	15	6	13	7	2	0	0	3	<b>874</b>
12 PM	21	790	100	3	9	16	5	4	11	0	0	<b>1</b>	<b>11</b>	971
13:00	21	841	125	6	11	24	11	13	14	2	0	0	3	1071
14:00	34	950	122	7	10	<b>30</b>	7	11	12	0	2	0	5	1190
15:00	36	991	155	8	<b>14</b>	20	9	13	<b>18</b>	<b>3</b>	0	1	8	1276
16:00	42	1099	193	6	13	21	13	15	11	2	<b>5</b>	1	4	1425
17:00	<b>46</b>	<b>1265</b>	<b>198</b>	<b>12</b>	6	28	<b>14</b>	<b>22</b>	12	1	1	0	2	<b>1607</b>
18:00	22	907	123	1	5	21	9	11	10	0	2	0	4	1115
19:00	19	727	95	0	4	2	5	7	6	0	0	0	1	866
20:00	4	527	52	0	2	1	3	5	4	0	0	0	1	599
21:00	4	308	28	0	0	1	0	0	1	0	0	0	0	342
22:00	2	188	12	0	0	0	0	1	1	0	0	0	0	204
23:00	0	89	3	0	1	0	0	0	4	0	0	0	0	97
Day Total	373	12340	1758	66	147	252	107	181	177	14	15	5	54	15489
Percent	2.4%	79.7%	11.3%	0.4%	0.9%	1.6%	0.7%	1.2%	1.1%	0.1%	0.1%	0.0%	0.3%	
AM Peak	08:00	11:00	08:00	09:00	09:00	07:00	08:00	09:00	09:00	07:00	09:00	07:00	07:00	11:00
Vol.	26	689	121	8	18	22	7	16	14	2	3	1	3	874
PM Peak	17:00	17:00	17:00	17:00	15:00	14:00	17:00	17:00	15:00	15:00	16:00	12:00	12:00	17:00
Vol.	46	1265	198	12	14	30	14	22	18	3	5	1	11	1607
Grand Total	3144	79258	12292	513	898	1582	705	1106	1062	82	119	36	354	101151
Percent	3.1%	78.4%	12.2%	0.5%	0.9%	1.6%	0.7%	1.1%	1.0%	0.1%	0.1%	0.0%	0.3%	



**All Traffic Data Services**  
www.alltrafficdata.net

Site Code: 4  
Station ID:  
US-160 W/O US-550

WB

Start Time	Bikes	Cars & Trailers	2 Axle Long	Buses	2 Axle 6 Tire	3 Axle Single	4 Axle Single	<5 Axl Double	5 Axle Double	>6 Axl Double	<6 Axl Multi	6 Axle Multi	>6 Axl Multi	Total
09/27/18	1	25	0	0	1	0	1	0	0	0	0	0	0	28
01:00	0	24	2	0	0	0	0	0	2	0	0	0	0	28
02:00	0	27	3	0	0	0	0	0	2	0	0	0	0	32
03:00	1	38	5	0	1	0	1	1	3	0	0	0	0	50
04:00	3	63	8	0	0	0	0	1	3	0	0	0	0	78
05:00	3	231	29	0	1	1	0	2	7	0	0	0	1	275
06:00	10	588	149	3	5	7	2	10	4	1	1	1	4	785
07:00	<b>55</b>	<b>1110</b>	<b>276</b>	<b>22</b>	17	25	<b>13</b>	8	<b>18</b>	<b>5</b>	2	1	<b>7</b>	<b>1559</b>
08:00	32	1051	225	8	9	21	7	<b>15</b>	17	0	2	0	5	1392
09:00	35	841	166	4	14	<b>27</b>	1	12	12	0	<b>3</b>	<b>2</b>	3	1120
10:00	21	839	142	4	<b>26</b>	23	11	8	18	0	0	0	4	1096
11:00	18	855	155	2	15	21	4	6	15	1	0	1	3	1096
12 PM	25	794	<b>158</b>	1	<b>17</b>	21	4	<b>14</b>	<b>23</b>	1	<b>5</b>	0	3	1066
13:00	21	818	154	3	12	20	2	8	14	0	1	0	1	1054
14:00	15	796	116	6	12	<b>27</b>	2	7	8	1	0	0	<b>5</b>	995
15:00	<b>35</b>	829	132	2	14	17	6	13	15	<b>2</b>	0	0	1	1066
16:00	30	<b>1015</b>	147	<b>8</b>	15	18	7	10	11	1	5	<b>2</b>	2	<b>1271</b>
17:00	26	835	123	6	15	13	<b>9</b>	12	1	2	0	0	1	1043
18:00	9	652	79	1	1	3	3	6	5	0	2	0	1	762
19:00	6	382	49	2	3	3	2	2	7	0	0	0	0	456
20:00	6	298	22	1	2	0	0	2	6	0	0	0	0	337
21:00	1	218	20	0	1	0	0	1	3	0	0	0	2	246
22:00	0	105	5	0	0	1	0	0	1	0	0	0	0	112
23:00	1	61	8	0	0	2	0	1	2	0	0	0	0	75
Day Total	354	12495	2173	73	181	250	75	139	197	14	21	7	43	16022
Percent	2.2%	78.0%	13.6%	0.5%	1.1%	1.6%	0.5%	0.9%	1.2%	0.1%	0.1%	0.0%	0.3%	
AM Peak	07:00	07:00	07:00	07:00	10:00	09:00	07:00	08:00	07:00	07:00	09:00	09:00	07:00	07:00
Vol.	55	1110	276	22	26	27	13	15	18	5	3	2	7	1559
PM Peak	15:00	16:00	12:00	16:00	12:00	14:00	17:00	12:00	12:00	15:00	12:00	16:00	14:00	16:00
Vol.	35	1015	158	8	17	27	9	14	23	2	5	2	5	1271

**All Traffic Data Services**  
www.alltrafficdata.net

Site Code: 4  
Station ID:  
US-160 W/O US-550

WB

Start Time	Bikes	Cars & Trailers	2 Axle Long	Buses	2 Axle 6 Tire	3 Axle Single	4 Axle Single	<5 Axl Double	5 Axle Double	>6 Axl Double	<6 Axl Multi	6 Axle Multi	>6 Axl Multi	Total
09/28/18	0	29	3	0	0	0	0	0	0	0	0	0	0	32
01:00	0	28	1	0	1	0	0	0	3	0	0	0	0	33
02:00	0	28	0	0	0	0	0	0	0	0	0	0	0	28
03:00	0	40	2	0	1	0	0	2	2	0	0	0	0	47
04:00	0	70	14	0	0	0	0	1	2	0	0	0	0	87
05:00	3	192	26	2	1	0	0	5	3	0	0	0	1	233
06:00	7	518	106	1	7	11	1	13	10	0	0	0	1	675
07:00	<b>72</b>	<b>1085</b>	<b>299</b>	<b>18</b>	<b>16</b>	<b>24</b>	<b>15</b>	<b>20</b>	7	<b>2</b>	0	<b>1</b>	3	<b>1562</b>
08:00	36	1018	216	4	11	17	7	14	<b>23</b>	0	1	0	2	1349
09:00	19	920	150	2	9	21	4	15	13	0	0	0	3	1156
10:00	34	893	148	4	11	24	4	13	11	0	<b>2</b>	0	4	1148
11:00	23	916	165	3	10	21	5	15	15	0	2	0	<b>5</b>	1180
12 PM	<b>35</b>	849	<b>161</b>	1	13	17	3	9	<b>15</b>	<b>1</b>	1	0	2	1107
13:00	33	820	136	3	11	<b>20</b>	3	<b>12</b>	11	0	2	0	1	1052
14:00	29	930	135	2	8	15	8	8	10	1	1	0	3	1150
15:00	33	930	141	6	<b>19</b>	11	5	11	11	0	2	0	2	<b>1171</b>
16:00	29	<b>942</b>	130	3	4	17	<b>9</b>	7	13	1	2	0	<b>5</b>	1162
17:00	24	904	133	<b>8</b>	8	10	3	10	8	0	2	<b>1</b>	2	1113
18:00	18	700	68	2	8	7	0	2	8	0	<b>3</b>	0	1	817
19:00	16	442	49	0	0	2	0	4	3	0	0	0	1	517
20:00	2	365	27	0	2	0	0	2	4	0	1	0	0	403
21:00	2	284	29	3	7	2	0	2	1	0	0	0	1	331
22:00	3	179	14	0	2	1	1	0	1	0	0	0	1	202
23:00	2	89	3	0	3	0	0	0	1	0	0	0	0	98
Day Total	420	13171	2156	62	152	220	68	165	175	5	19	2	38	16653
Percent	2.5%	79.1%	12.9%	0.4%	0.9%	1.3%	0.4%	1.0%	1.1%	0.0%	0.1%	0.0%	0.2%	
AM Peak	07:00	07:00	07:00	07:00	07:00	07:00	07:00	07:00	08:00	07:00	10:00	07:00	11:00	07:00
Vol.	72	1085	299	18	16	24	15	20	23	2	2	1	5	1562
PM Peak	12:00	16:00	12:00	17:00	15:00	13:00	16:00	13:00	12:00	12:00	18:00	17:00	16:00	15:00
Vol.	35	942	161	8	19	20	9	12	15	1	3	1	5	1171

**All Traffic Data Services**  
www.alltrafficdata.net

Site Code: 4  
Station ID:  
US-160 W/O US-550

WB

Start Time	Bikes	Cars & Trailers	2 Axle Long	Buses	2 Axle 6 Tire	3 Axle Single	4 Axle Single	<5 Axl Double	5 Axle Double	>6 Axl Double	<6 Axl Multi	6 Axle Multi	>6 Axl Multi	Total
09/29/18	0	54	2	0	0	0	0	1	0	0	0	0	0	57
01:00	1	37	4	0	1	0	0	0	2	0	0	0	0	45
02:00	0	33	4	0	0	0	0	0	2	0	0	0	0	39
03:00	1	32	4	0	0	1	0	0	2	0	0	0	0	40
04:00	0	67	5	0	0	0	0	0	4	0	0	0	0	76
05:00	0	111	13	2	1	0	0	1	4	0	0	0	0	132
06:00	1	229	36	1	5	4	1	1	3	0	0	0	0	281
07:00	13	471	71	1	2	5	2	2	5	0	0	0	1	573
08:00	21	691	136	2	6	6	2	5	2	1	1	0	0	873
09:00	21	859	<b>143</b>	<b>5</b>	5	<b>10</b>	2	<b>12</b>	5	0	<b>2</b>	0	<b>2</b>	1066
10:00	<b>40</b>	<b>876</b>	135	2	3	5	4	7	<b>11</b>	1	0	0	2	<b>1086</b>
11:00	33	874	124	1	<b>9</b>	5	<b>8</b>	12	10	0	0	0	1	1077
12 PM	24	<b>873</b>	113	1	4	9	4	5	<b>9</b>	0	1	0	<b>1</b>	<b>1044</b>
13:00	<b>36</b>	793	<b>133</b>	0	<b>8</b>	3	4	5	9	0	<b>3</b>	0	0	994
14:00	13	722	94	0	5	7	3	<b>8</b>	4	1	0	0	1	858
15:00	24	743	98	0	4	6	<b>5</b>	5	3	<b>2</b>	1	0	0	891
16:00	21	780	79	1	7	<b>10</b>	3	6	3	0	1	0	0	911
17:00	12	688	77	0	2	0	3	5	3	0	0	0	0	790
18:00	14	534	79	0	0	1	3	4	2	0	1	0	1	639
19:00	3	431	34	0	3	4	1	1	4	0	0	0	0	481
20:00	4	316	35	<b>3</b>	0	2	0	0	3	0	0	0	0	363
21:00	0	257	31	0	1	1	0	0	1	0	0	0	0	291
22:00	3	143	17	0	0	0	1	0	0	0	1	0	0	165
23:00	2	84	18	0	1	0	0	0	2	0	0	0	0	107
Day Total	287	10698	1485	19	67	79	46	80	93	5	11	0	9	12879
Percent	2.2%	83.1%	11.5%	0.1%	0.5%	0.6%	0.4%	0.6%	0.7%	0.0%	0.1%	0.0%	0.1%	
AM Peak	10:00	10:00	09:00	09:00	11:00	09:00	11:00	09:00	10:00	08:00	09:00		09:00	10:00
Vol.	40	876	143	5	9	10	8	12	11	1	2		2	1086
PM Peak	13:00	12:00	13:00	20:00	13:00	16:00	15:00	14:00	12:00	15:00	13:00		12:00	12:00
Vol.	36	873	133	3	8	10	5	8	9	2	3		1	1044

**All Traffic Data Services**  
www.alltrafficdata.net

Site Code: 4  
Station ID:  
US-160 W/O US-550

WB

Start Time	Bikes	Cars & Trailers	2 Axle Long	Buses	2 Axle 6 Tire	3 Axle Single	4 Axle Single	<5 Axl Double	5 Axle Double	>6 Axl Double	<6 Axl Multi	6 Axle Multi	>6 Axl Multi	Total
09/30/18	0	61	6	0	3	0	0	0	0	0	0	0	0	70
01:00	0	41	8	0	0	0	0	0	2	0	0	0	0	51
02:00	0	33	2	0	0	0	0	0	0	0	0	0	0	35
03:00	0	26	0	0	0	0	0	0	3	0	0	0	0	29
04:00	0	34	3	0	0	0	0	0	1	0	0	0	0	38
05:00	2	64	14	0	0	0	0	0	3	0	0	0	0	83
06:00	1	167	26	0	1	2	0	0	0	0	0	0	0	197
07:00	6	280	44	1	2	1	0	0	2	0	0	0	0	336
08:00	14	518	91	2	4	1	3	5	4	0	0	0	0	642
09:00	17	657	91	0	<b>5</b>	3	3	8	<b>6</b>	0	<b>1</b>	0	0	791
10:00	<b>26</b>	<b>791</b>	98	<b>3</b>	3	<b>9</b>	4	<b>13</b>	5	0	0	0	<b>1</b>	<b>953</b>
11:00	22	767	<b>116</b>	1	2	3	<b>6</b>	11	6	0	0	0	1	935
12 PM	21	718	<b>100</b>	1	1	4	0	<b>9</b>	<b>6</b>	0	<b>2</b>	<b>1</b>	1	864
13:00	21	<b>741</b>	89	<b>2</b>	2	5	<b>4</b>	3	4	0	0	0	1	<b>872</b>
14:00	10	672	81	2	5	<b>6</b>	2	8	5	0	1	0	1	793
15:00	<b>24</b>	679	87	1	<b>6</b>	5	1	5	2	<b>1</b>	0	0	0	811
16:00	14	602	78	0	6	4	0	4	3	0	0	0	0	711
17:00	17	581	74	2	2	0	3	6	3	0	0	0	<b>3</b>	691
18:00	15	481	56	1	3	2	4	1	3	0	1	0	0	567
19:00	10	349	54	0	1	2	0	4	3	0	0	0	0	423
20:00	6	266	29	0	0	1	1	0	3	0	0	0	1	307
21:00	1	180	17	0	1	1	1	2	3	0	0	0	0	206
22:00	1	100	12	0	1	1	0	2	2	0	0	0	0	119
23:00	0	54	6	2	2	0	0	1	0	0	0	0	0	65
Day Total	228	8862	1182	18	50	50	32	82	69	1	5	1	9	10589
Percent	2.2%	83.7%	11.2%	0.2%	0.5%	0.5%	0.3%	0.8%	0.7%	0.0%	0.0%	0.0%	0.1%	
AM Peak	10:00	10:00	11:00	10:00	09:00	10:00	11:00	10:00	09:00		09:00		10:00	10:00
Vol.	26	791	116	3	5	9	6	13	6		1		1	953
PM Peak	15:00	13:00	12:00	13:00	15:00	14:00	13:00	12:00	12:00	15:00	12:00	12:00	17:00	13:00
Vol.	24	741	100	2	6	6	4	9	6	1	2	1	3	872



**All Traffic Data Services**  
www.alltrafficdata.net

Site Code: 4  
Station ID:  
US-160 W/O US-550

WB

Start Time	Bikes	Cars & Trailers	2 Axle Long	Buses	2 Axle 6 Tire	3 Axle Single	4 Axle Single	<5 Axl Double	5 Axle Double	>6 Axl Double	<6 Axl Multi	6 Axle Multi	>6 Axl Multi	Total
10/01/18	0	32	3	0	1	0	0	0	1	0	0	0	0	37
01:00	0	24	2	0	1	1	0	0	6	0	0	0	0	34
02:00	0	29	1	0	0	0	0	1	2	0	0	0	0	33
03:00	0	45	3	0	0	0	0	0	3	0	0	0	0	51
04:00	2	61	9	0	1	0	1	0	2	0	0	0	0	76
05:00	2	211	34	1	1	6	1	1	5	0	0	0	0	262
06:00	7	561	144	0	6	5	1	8	5	0	1	0	1	739
07:00	39	<b>1257</b>	<b>230</b>	<b>14</b>	9	13	<b>11</b>	18	11	<b>1</b>	1	0	4	<b>1608</b>
08:00	<b>43</b>	1074	223	2	11	18	10	<b>25</b>	9	1	1	0	5	1422
09:00	24	859	171	3	7	21	7	9	<b>15</b>	0	0	0	3	1119
10:00	15	846	156	4	<b>16</b>	<b>22</b>	2	9	13	1	0	0	1	1085
11:00	20	833	137	0	13	16	7	3	13	1	<b>3</b>	0	<b>8</b>	1054
12 PM	21	805	<b>176</b>	5	16	16	3	<b>17</b>	14	0	2	0	3	1078
13:00	22	739	140	2	12	18	2	10	<b>24</b>	0	1	<b>1</b>	2	973
14:00	21	783	147	<b>6</b>	<b>23</b>	<b>20</b>	2	12	16	<b>1</b>	0	0	<b>5</b>	1036
15:00	13	831	151	5	9	12	<b>4</b>	13	16	1	1	0	2	1058
16:00	20	<b>892</b>	154	3	13	12	2	11	7	1	<b>3</b>	0	4	<b>1122</b>
17:00	<b>25</b>	832	153	3	5	13	3	14	11	0	1	0	2	1062
18:00	4	527	77	1	4	2	4	4	7	0	0	0	0	630
19:00	4	309	34	0	2	2	2	2	4	1	0	0	0	360
20:00	4	198	29	1	2	2	0	2	3	0	0	0	0	241
21:00	3	200	19	0	2	1	0	0	6	0	0	0	0	231
22:00	1	78	3	0	0	0	0	0	3	0	0	0	0	85
23:00	0	54	6	0	0	0	0	1	0	0	0	0	0	61
Day Total	290	12080	2202	50	154	200	62	160	196	8	14	1	40	15457
Percent	1.9%	78.2%	14.2%	0.3%	1.0%	1.3%	0.4%	1.0%	1.3%	0.1%	0.1%	0.0%	0.3%	
AM Peak	08:00	07:00	07:00	07:00	10:00	10:00	07:00	08:00	09:00	07:00	11:00		11:00	07:00
Vol.	43	1257	230	14	16	22	11	25	15	1	3		8	1608
PM Peak	17:00	16:00	12:00	14:00	14:00	14:00	15:00	12:00	13:00	14:00	16:00	13:00	14:00	16:00
Vol.	25	892	176	6	23	20	4	17	24	1	3	1	5	1122

**All Traffic Data Services**  
www.alltrafficdata.net

Site Code: 4  
Station ID:  
US-160 W/O US-550

WB

Start Time	Bikes	Cars & Trailers	2 Axle Long	Buses	2 Axle 6 Tire	3 Axle Single	4 Axle Single	<5 Axl Double	5 Axle Double	>6 Axl Double	<6 Axl Multi	6 Axle Multi	>6 Axl Multi	Total
10/02/18	0	27	3	0	0	0	0	0	4	0	0	0	0	34
01:00	0	14	1	0	0	0	0	0	3	0	0	0	0	18
02:00	0	23	2	0	0	0	0	0	1	0	0	0	0	26
03:00	0	48	6	0	0	3	0	0	2	0	0	0	0	59
04:00	0	70	11	0	0	0	0	1	1	0	0	0	0	83
05:00	1	230	26	0	1	1	0	2	8	1	0	0	0	270
06:00	8	616	141	1	6	7	3	8	5	0	0	0	0	795
07:00	<b>46</b>	<b>1158</b>	199	<b>15</b>	11	<b>30</b>	<b>9</b>	15	7	2	<b>2</b>	<b>1</b>	<b>4</b>	<b>1499</b>
08:00	30	1108	<b>225</b>	8	<b>17</b>	29	4	<b>17</b>	12	<b>3</b>	1	1	3	1458
09:00	18	873	178	2	12	23	6	9	8	0	1	0	4	1134
10:00	15	867	147	3	8	18	4	7	<b>17</b>	1	1	0	3	1091
11:00	13	851	145	2	16	17	3	10	12	0	1	1	4	1075
12 PM	18	803	128	1	9	15	<b>7</b>	8	12	0	1	0	<b>7</b>	1009
13:00	16	739	131	1	9	<b>20</b>	5	12	<b>15</b>	1	1	0	7	957
14:00	16	837	122	2	<b>15</b>	16	0	8	13	1	2	0	0	1032
15:00	15	845	124	<b>3</b>	9	18	3	10	12	<b>2</b>	2	0	1	1044
16:00	<b>29</b>	<b>901</b>	126	3	8	13	5	<b>14</b>	7	1	<b>3</b>	<b>1</b>	3	<b>1114</b>
17:00	15	872	<b>137</b>	3	12	12	5	5	5	1	1	0	2	1070
18:00	13	542	80	1	7	1	1	4	4	0	0	0	0	653
19:00	2	354	33	0	0	1	0	0	4	0	1	0	0	395
20:00	1	222	23	1	2	0	0	0	5	0	0	0	1	255
21:00	1	177	20	2	1	2	0	0	3	0	0	0	0	206
22:00	1	80	14	0	1	1	0	0	3	0	0	0	1	101
23:00	0	59	4	0	0	0	0	1	1	0	0	0	0	65
Day Total	258	12316	2026	48	144	227	55	131	164	13	17	4	40	15443
Percent	1.7%	79.8%	13.1%	0.3%	0.9%	1.5%	0.4%	0.8%	1.1%	0.1%	0.1%	0.0%	0.3%	
AM Peak	07:00	07:00	08:00	07:00	08:00	07:00	07:00	08:00	10:00	08:00	07:00	07:00	07:00	07:00
Vol.	46	1158	225	15	17	30	9	17	17	3	2	1	4	1499
PM Peak	16:00	16:00	17:00	15:00	14:00	13:00	12:00	16:00	13:00	15:00	16:00	16:00	12:00	16:00
Vol.	29	901	137	3	15	20	7	14	15	2	3	1	7	1114

**All Traffic Data Services**  
www.alltrafficdata.net

Site Code: 4  
Station ID:  
US-160 W/O US-550

WB

Start Time	Bikes	Cars & Trailers	2 Axle Long	Buses	2 Axle 6 Tire	3 Axle Single	4 Axle Single	<5 Axl Double	5 Axle Double	>6 Axl Double	<6 Axl Multi	6 Axle Multi	>6 Axl Multi	Total
10/03/18	0	26	4	1	3	0	0	0	1	0	0	0	0	35
01:00	0	21	1	0	1	0	0	0	2	0	0	0	0	25
02:00	1	23	4	0	0	0	0	1	1	0	0	0	0	30
03:00	0	35	6	0	0	0	0	0	2	0	0	0	1	44
04:00	0	62	15	0	1	1	0	1	4	0	0	0	0	84
05:00	0	230	25	0	1	1	0	1	3	0	0	0	0	261
06:00	12	613	140	5	8	7	3	6	3	0	0	0	2	799
07:00	<b>73</b>	<b>1048</b>	<b>239</b>	<b>25</b>	9	17	<b>12</b>	13	7	<b>1</b>	0	<b>1</b>	<b>12</b>	<b>1457</b>
08:00	37	1004	208	22	<b>19</b>	<b>25</b>	10	<b>24</b>	<b>16</b>	1	1	0	5	1372
09:00	21	890	192	5	13	15	5	11	13	1	<b>2</b>	1	2	1171
10:00	18	839	176	1	15	16	1	11	15	1	1	0	1	1095
11:00	29	896	139	5	12	19	0	13	14	0	2	0	3	1132
12 PM	23	856	130	2	8	<b>25</b>	0	5	10	1	0	0	2	1062
13:00	24	770	105	<b>5</b>	13	20	1	<b>15</b>	<b>17</b>	1	0	0	1	972
14:00	20	795	<b>142</b>	3	<b>15</b>	20	6	9	11	1	1	0	<b>4</b>	1027
15:00	<b>27</b>	853	118	2	15	21	5	12	12	1	1	0	1	1068
16:00	23	<b>975</b>	139	4	12	17	<b>7</b>	9	8	<b>2</b>	<b>2</b>	<b>1</b>	3	<b>1202</b>
17:00	17	930	110	4	4	12	3	7	9	0	1	0	1	1098
18:00	20	604	80	1	4	5	3	3	3	0	0	0	2	725
19:00	5	381	39	0	5	4	0	2	1	0	0	0	0	437
20:00	2	235	31	0	2	1	2	1	3	0	0	0	0	277
21:00	2	203	31	0	0	2	1	3	4	0	0	0	0	246
22:00	1	111	11	0	1	0	0	0	5	0	0	0	0	129
23:00	1	70	3	0	1	0	0	0	4	0	0	0	0	79
Day Total	356	12470	2088	85	162	228	59	147	168	10	11	3	40	15827
Percent	2.2%	78.8%	13.2%	0.5%	1.0%	1.4%	0.4%	0.9%	1.1%	0.1%	0.1%	0.0%	0.3%	
AM Peak	07:00	07:00	07:00	07:00	08:00	08:00	07:00	08:00	08:00	07:00	09:00	07:00	07:00	07:00
Vol.	73	1048	239	25	19	25	12	24	16	1	2	1	12	1457
PM Peak	15:00	16:00	14:00	13:00	14:00	12:00	16:00	13:00	13:00	16:00	16:00	16:00	14:00	16:00
Vol.	27	975	142	5	15	25	7	15	17	2	2	1	4	1202
Grand Total	2193	82092	13312	355	910	1254	397	904	1062	56	98	18	219	102870
Percent	2.1%	79.8%	12.9%	0.3%	0.9%	1.2%	0.4%	0.9%	1.0%	0.1%	0.1%	0.0%	0.2%	

**All Traffic Data Services**  
www.alltrafficdata.net

Site Code: 5  
Station ID:  
US-160 W/O CR 232

**EB**

Start Time	Bikes	Cars & Trailers	2 Axle Long	Buses	2 Axle 6 Tire	3 Axle Single	4 Axle Single	<5 Axl Double	5 Axle Double	>6 Axl Double	<6 Axl Multi	6 Axle Multi	>6 Axl Multi	Total
09/27/18	0	27	4	0	0	0	0	0	1	0	0	0	0	32
01:00	0	14	5	0	0	1	0	0	0	0	0	0	0	20
02:00	0	17	3	0	2	0	0	0	2	0	0	0	0	24
03:00	0	17	1	0	1	1	0	0	0	0	0	0	0	20
04:00	1	37	8	0	0	1	0	0	4	0	0	0	0	51
05:00	2	85	25	0	0	3	0	0	3	0	0	0	0	118
06:00	1	225	59	1	5	4	0	4	7	0	0	0	0	306
07:00	9	384	109	1	17	<b>19</b>	<b>3</b>	5	<b>16</b>	2	0	0	<b>2</b>	567
08:00	14	458	<b>113</b>	<b>5</b>	15	6	0	6	7	<b>3</b>	<b>3</b>	0	2	<b>632</b>
09:00	<b>21</b>	458	85	2	13	8	2	5	9	1	1	0	2	607
10:00	18	471	84	2	<b>19</b>	5	1	<b>10</b>	14	0	0	0	1	625
11:00	9	<b>474</b>	67	4	13	13	3	7	12	2	0	<b>1</b>	1	606
12 PM	19	524	77	8	13	<b>9</b>	3	2	<b>16</b>	0	<b>1</b>	0	<b>2</b>	674
13:00	16	506	66	6	9	6	<b>4</b>	7	7	0	0	0	2	629
14:00	21	531	63	2	<b>20</b>	4	1	3	7	1	1	<b>1</b>	0	655
15:00	12	520	75	1	9	9	3	5	11	0	0	1	2	648
16:00	<b>23</b>	654	86	3	9	9	3	<b>8</b>	10	0	0	0	0	805
17:00	9	<b>768</b>	<b>89</b>	<b>11</b>	4	5	2	7	2	0	0	0	0	<b>897</b>
18:00	6	491	73	2	8	2	1	5	2	<b>2</b>	0	0	0	592
19:00	8	466	69	4	7	5	3	4	5	1	1	0	1	574
20:00	5	292	29	1	3	0	0	2	3	0	0	0	1	336
21:00	2	206	19	0	0	0	0	2	0	0	0	0	0	229
22:00	3	130	10	0	1	0	0	0	0	0	0	0	0	144
23:00	0	67	4	0	1	0	0	0	4	0	0	0	0	76
Day Total	199	7822	1223	53	169	110	29	82	142	12	7	3	16	9867
Percent	2.0%	79.3%	12.4%	0.5%	1.7%	1.1%	0.3%	0.8%	1.4%	0.1%	0.1%	0.0%	0.2%	
AM Peak	09:00	11:00	08:00	08:00	10:00	07:00	07:00	10:00	07:00	08:00	08:00	11:00	07:00	08:00
Vol.	21	474	113	5	19	19	3	10	16	3	3	1	2	632
PM Peak	16:00	17:00	17:00	17:00	14:00	12:00	13:00	16:00	12:00	18:00	12:00	14:00	12:00	17:00
Vol.	23	768	89	11	20	9	4	8	16	2	1	1	2	897

**All Traffic Data Services**  
www.alltrafficdata.net

Site Code: 5  
Station ID:  
US-160 W/O CR 232

EB

Start Time	Bikes	Cars & Trailers	2 Axle Long	Buses	2 Axle 6 Tire	3 Axle Single	4 Axle Single	<5 Axl Double	5 Axle Double	>6 Axl Double	<6 Axl Multi	6 Axle Multi	>6 Axl Multi	Total
09/28/18	0	27	2	0	1	0	0	0	1	0	0	0	0	31
01:00	0	17	1	0	0	0	0	0	0	0	0	0	0	18
02:00	1	21	2	0	0	0	0	0	3	0	0	0	0	27
03:00	0	15	3	0	1	0	0	0	4	0	0	0	0	23
04:00	0	51	3	0	0	1	0	0	4	0	0	0	0	59
05:00	0	98	11	0	2	2	0	0	3	0	0	0	0	116
06:00	5	160	45	1	11	6	1	3	11	0	0	0	1	244
07:00	5	323	77	7	<b>18</b>	12	2	2	15	0	1	0	0	462
08:00	9	452	<b>89</b>	4	13	7	2	1	8	0	0	0	1	586
09:00	17	440	77	<b>9</b>	12	11	1	4	11	0	<b>2</b>	0	1	585
10:00	10	493	71	7	12	13	<b>4</b>	<b>10</b>	<b>21</b>	<b>1</b>	0	<b>1</b>	1	644
11:00	<b>24</b>	<b>505</b>	73	7	12	<b>16</b>	2	6	4	1	0	0	1	<b>651</b>
12 PM	16	573	73	4	10	<b>12</b>	1	<b>11</b>	8	<b>1</b>	0	0	0	709
13:00	15	472	80	<b>9</b>	8	9	1	6	<b>12</b>	0	0	0	0	612
14:00	15	496	82	5	<b>14</b>	4	<b>3</b>	4	8	0	0	<b>2</b>	0	633
15:00	<b>17</b>	531	65	3	8	7	0	4	5	0	0	0	0	640
16:00	11	<b>635</b>	<b>88</b>	7	7	11	1	2	3	1	<b>1</b>	0	<b>1</b>	<b>768</b>
17:00	14	599	74	1	5	2	1	5	2	0	1	0	1	705
18:00	10	448	42	4	2	2	0	3	2	0	0	0	0	513
19:00	5	382	54	1	2	2	1	4	6	0	1	0	1	459
20:00	4	296	38	2	2	3	0	1	1	1	0	0	0	348
21:00	1	221	22	0	0	0	0	0	0	0	0	1	0	245
22:00	2	162	13	0	1	0	0	0	4	0	0	0	0	182
23:00	2	110	10	0	3	0	0	0	1	0	0	0	0	126
Day Total	183	7527	1095	71	144	120	20	66	137	5	6	4	8	9386
Percent	1.9%	80.2%	11.7%	0.8%	1.5%	1.3%	0.2%	0.7%	1.5%	0.1%	0.1%	0.0%	0.1%	
AM Peak	11:00	11:00	08:00	09:00	07:00	11:00	10:00	10:00	10:00	10:00	09:00	10:00	06:00	11:00
Vol.	24	505	89	9	18	16	4	10	21	1	2	1	1	651
PM Peak	15:00	16:00	16:00	13:00	14:00	12:00	14:00	12:00	13:00	12:00	16:00	14:00	16:00	16:00
Vol.	17	635	88	9	14	12	3	11	12	1	1	2	1	768



**All Traffic Data Services**  
www.alltrafficdata.net

Site Code: 5  
Station ID:  
US-160 W/O CR 232

**EB**

Start Time	Bikes	Cars & Trailers	2 Axle Long	Buses	2 Axle 6 Tire	3 Axle Single	4 Axle Single	<5 Axl Double	5 Axle Double	>6 Axl Double	<6 Axl Multi	6 Axle Multi	>6 Axl Multi	Total
09/29/18	0	43	3	1	0	0	0	0	1	0	0	0	0	48
01:00	0	24	5	0	0	0	0	0	1	0	0	0	0	30
02:00	1	32	7	0	1	0	0	1	1	0	0	0	0	43
03:00	1	20	3	0	1	0	0	0	2	0	0	0	0	27
04:00	0	50	7	0	1	0	0	0	2	0	0	0	0	60
05:00	0	51	6	0	0	1	0	0	0	0	0	0	0	58
06:00	3	103	16	1	3	0	0	0	0	0	0	0	0	126
07:00	3	139	27	3	2	2	0	1	0	0	0	1	0	178
08:00	12	271	31	2	4	3	1	0	7	0	1	0	2	334
09:00	6	309	42	4	5	5	2	5	3	0	0	0	0	381
10:00	16	373	62	1	8	2	1	5	2	0	0	0	0	470
11:00	8	444	42	4	9	4	0	4	1	1	0	0	0	517
12 PM	16	425	57	3	4	0	2	3	5	1	2	0	0	518
13:00	11	439	42	5	1	3	1	6	6	0	0	0	0	514
14:00	20	411	56	1	3	1	0	2	1	1	1	0	0	497
15:00	13	425	42	0	4	2	0	4	5	0	1	0	0	496
16:00	11	389	42	6	5	1	1	4	3	0	0	0	0	462
17:00	4	371	34	2	2	1	0	1	2	0	0	1	0	418
18:00	9	322	45	1	2	0	0	1	1	0	0	0	0	381
19:00	6	296	33	4	0	3	0	1	2	0	0	0	0	345
20:00	5	241	23	0	1	0	0	0	2	1	0	0	0	273
21:00	3	165	15	0	2	0	0	0	2	0	0	0	0	187
22:00	0	122	7	0	1	0	0	0	3	0	0	0	0	133
23:00	0	96	10	1	1	0	0	0	1	0	0	0	0	109
Day Total	148	5561	657	39	60	28	8	38	53	4	5	2	2	6605
Percent	2.2%	84.2%	9.9%	0.6%	0.9%	0.4%	0.1%	0.6%	0.8%	0.1%	0.1%	0.0%	0.0%	
AM Peak	10:00	11:00	10:00	09:00	11:00	09:00	09:00	09:00	08:00	11:00	08:00	07:00	08:00	11:00
Vol.	16	444	62	4	9	5	2	5	7	1	1	1	2	517
PM Peak	14:00	13:00	12:00	16:00	16:00	13:00	12:00	13:00	13:00	12:00	12:00	17:00		12:00
Vol.	20	439	57	6	5	3	2	6	6	1	2	1		518

**All Traffic Data Services**  
www.alltrafficdata.net

Site Code: 5  
Station ID:  
US-160 W/O CR 232

**EB**

Start Time	Bikes	Cars & Trailers	2 Axle Long	Buses	2 Axle 6 Tire	3 Axle Single	4 Axle Single	<5 Axl Double	5 Axle Double	>6 Axl Double	<6 Axl Multi	6 Axle Multi	>6 Axl Multi	Total
09/30/18	0	36	2	0	0	1	0	0	1	0	0	0	0	40
01:00	0	42	3	0	0	0	0	0	1	0	0	0	0	46
02:00	0	27	4	0	0	0	0	0	0	0	0	0	0	31
03:00	0	16	2	0	0	0	0	0	0	0	0	0	0	18
04:00	1	22	3	1	0	0	0	0	1	0	0	0	0	28
05:00	1	51	6	0	0	0	0	0	0	0	0	0	0	58
06:00	2	66	10	0	0	2	0	0	2	0	0	0	0	82
07:00	2	107	15	0	2	0	0	0	2	0	0	0	0	128
08:00	6	191	18	0	0	1	0	1	5	0	0	0	0	222
09:00	15	307	29	3	1	1	0	4	5	0	0	0	0	365
10:00	13	337	43	1	2	2	1	1	3	0	1	0	0	404
11:00	11	373	41	7	5	3	0	8	4	0	0	0	0	452
12 PM	4	412	34	2	3	1	0	1	2	0	0	1	1	461
13:00	10	396	38	2	5	3	0	3	2	1	0	0	0	460
14:00	7	387	37	4	4	0	1	7	2	0	0	0	0	449
15:00	11	363	51	0	2	1	0	1	2	0	0	0	0	431
16:00	14	366	50	0	1	1	0	1	0	1	0	0	0	434
17:00	10	346	53	2	3	1	0	1	1	0	1	0	0	418
18:00	9	293	36	3	0	3	0	1	5	0	0	1	0	351
19:00	2	214	33	1	3	1	1	1	3	0	0	0	0	259
20:00	3	198	28	0	1	0	0	0	1	0	0	0	0	231
21:00	5	101	15	0	0	0	0	1	2	0	0	0	0	124
22:00	1	62	8	0	0	0	0	0	2	0	0	0	0	73
23:00	0	53	2	0	0	0	0	0	1	0	0	0	0	56
Day Total	127	4766	561	26	32	21	3	31	47	2	2	2	1	5621
Percent	2.3%	84.8%	10.0%	0.5%	0.6%	0.4%	0.1%	0.6%	0.8%	0.0%	0.0%	0.0%	0.0%	
AM Peak	09:00	11:00	10:00	11:00	11:00	11:00	10:00	11:00	08:00		10:00			11:00
Vol.	15	373	43	7	5	3	1	8	5		1			452
PM Peak	16:00	12:00	17:00	14:00	13:00	13:00	14:00	14:00	18:00	13:00	17:00	12:00	12:00	12:00
Vol.	14	412	53	4	5	3	1	7	5	1	1	1	1	461

**All Traffic Data Services**  
www.alltrafficdata.net

Site Code: 5  
Station ID:  
US-160 W/O CR 232

**EB**

Start Time	Bikes	Cars & Trailers	2 Axle Long	Buses	2 Axle 6 Tire	3 Axle Single	4 Axle Single	<5 Axl Double	5 Axle Double	>6 Axl Double	<6 Axl Multi	6 Axle Multi	>6 Axl Multi	Total
10/01/18	0	19	1	0	3	0	0	0	1	0	0	0	0	24
01:00	0	13	0	0	0	0	0	0	0	0	0	0	0	13
02:00	0	5	0	0	0	0	0	0	0	0	0	0	0	5
03:00	0	15	2	0	1	0	0	0	2	0	0	0	0	20
04:00	0	44	2	0	0	0	0	0	3	0	0	0	0	49
05:00	0	68	10	0	2	2	0	0	0	0	0	0	0	82
06:00	2	188	31	0	6	3	1	1	8	0	0	0	0	240
07:00	2	274	47	2	13	12	1	4	<b>14</b>	<b>1</b>	<b>1</b>	0	0	371
08:00	4	348	<b>77</b>	2	6	10	<b>2</b>	<b>7</b>	8	0	0	0	0	464
09:00	<b>8</b>	351	58	<b>9</b>	14	9	1	6	8	0	0	0	0	464
10:00	7	382	66	2	9	10	0	4	11	1	1	0	<b>1</b>	494
11:00	2	<b>405</b>	58	5	<b>15</b>	<b>16</b>	2	5	6	1	1	0	0	<b>516</b>
12 PM	7	441	71	<b>8</b>	<b>15</b>	<b>13</b>	0	4	8	0	0	0	0	567
13:00	<b>19</b>	417	75	1	11	9	1	4	<b>10</b>	<b>2</b>	<b>2</b>	0	<b>1</b>	552
14:00	7	479	73	0	14	8	1	<b>5</b>	10	0	1	0	0	598
15:00	7	498	63	3	8	6	0	2	5	0	0	0	1	593
16:00	13	606	88	7	14	5	1	2	7	0	0	0	0	743
17:00	9	<b>620</b>	<b>110</b>	3	10	1	<b>2</b>	5	1	0	0	<b>1</b>	0	<b>762</b>
18:00	9	405	76	1	5	6	0	1	3	0	0	0	0	506
19:00	0	275	36	0	1	0	0	1	7	0	0	0	0	320
20:00	2	199	13	0	0	2	0	0	3	0	0	0	0	219
21:00	2	115	10	1	5	1	0	0	0	0	0	0	0	134
22:00	1	65	9	0	2	0	0	1	2	0	0	0	0	80
23:00	2	34	2	0	0	0	0	0	1	0	0	0	0	39
Day Total	103	6266	978	44	154	113	12	52	118	5	6	1	3	7855
Percent	1.3%	79.8%	12.5%	0.6%	2.0%	1.4%	0.2%	0.7%	1.5%	0.1%	0.1%	0.0%	0.0%	
AM Peak	09:00	11:00	08:00	09:00	11:00	11:00	08:00	08:00	07:00	07:00	07:00		10:00	11:00
Vol.	8	405	77	9	15	16	2	7	14	1	1		1	516
PM Peak	13:00	17:00	17:00	12:00	12:00	12:00	17:00	14:00	13:00	13:00	13:00	17:00	13:00	17:00
Vol.	19	620	110	8	15	13	2	5	10	2	2	1	1	762

**All Traffic Data Services**  
www.alltrafficdata.net

Site Code: 5  
Station ID:  
US-160 W/O CR 232

**EB**

Start Time	Bikes	Cars & Trailers	2 Axle Long	Buses	2 Axle 6 Tire	3 Axle Single	4 Axle Single	<5 Axl Double	5 Axle Double	>6 Axl Double	<6 Axl Multi	6 Axle Multi	>6 Axl Multi	Total
10/02/18	0	32	2	0	0	0	0	0	0	0	0	0	0	34
01:00	0	10	1	0	0	0	0	0	1	0	0	0	0	12
02:00	0	8	2	0	1	0	0	0	2	0	0	0	0	13
03:00	0	14	1	0	1	1	0	0	0	0	0	0	0	17
04:00	0	38	5	0	1	0	0	0	1	0	0	0	0	45
05:00	3	72	11	0	1	1	0	2	1	0	0	0	0	91
06:00	1	195	35	3	9	11	0	1	7	0	0	0	0	262
07:00	6	283	63	4	9	9	2	6	9	0	0	0	0	391
08:00	8	332	73	2	17	6	1	7	8	0	0	0	0	454
09:00	13	336	55	0	13	6	2	5	10	1	0	0	0	441
10:00	9	376	68	2	21	11	2	10	12	1	1	0	0	513
11:00	4	370	65	1	12	13	3	4	6	1	1	0	1	481
12 PM	6	402	71	0	6	12	1	2	7	0	0	0	1	508
13:00	5	381	69	2	11	17	1	2	9	0	0	0	1	498
14:00	7	444	56	1	17	8	0	4	7	1	0	0	1	546
15:00	8	473	59	3	13	8	1	0	6	0	1	0	0	572
16:00	7	537	85	4	5	5	0	2	7	1	0	0	0	653
17:00	5	671	93	4	5	2	1	4	2	0	0	0	0	787
18:00	13	550	76	7	7	3	2	4	6	0	0	0	0	668
19:00	5	454	59	3	6	2	1	3	6	0	0	0	1	540
20:00	2	331	38	2	2	1	0	2	2	0	0	1	0	381
21:00	1	187	26	0	1	0	0	2	1	0	0	0	0	218
22:00	1	113	10	0	0	0	0	0	3	0	0	0	1	128
23:00	1	60	4	0	0	0	0	0	2	0	0	0	0	67
Day Total	105	6669	1027	38	158	116	17	60	115	5	3	1	6	8320
Percent	1.3%	80.2%	12.3%	0.5%	1.9%	1.4%	0.2%	0.7%	1.4%	0.1%	0.0%	0.0%	0.1%	
AM Peak	09:00	10:00	08:00	07:00	10:00	11:00	11:00	10:00	10:00	09:00	10:00		11:00	10:00
Vol.	13	376	73	4	21	13	3	10	12	1	1		1	513
PM Peak	18:00	17:00	17:00	18:00	14:00	13:00	18:00	14:00	13:00	14:00	15:00	20:00	12:00	17:00
Vol.	13	671	93	7	17	17	2	4	9	1	1	1	1	787

**All Traffic Data Services**  
www.alltrafficdata.net

Site Code: 5  
Station ID:  
US-160 W/O CR 232

**EB**

Start Time	Bikes	Cars & Trailers	2 Axle Long	Buses	2 Axle 6 Tire	3 Axle Single	4 Axle Single	<5 Axl Double	5 Axle Double	>6 Axl Double	<6 Axl Multi	6 Axle Multi	>6 Axl Multi	Total
10/03/18	0	28	4	0	0	0	0	0	1	0	0	0	0	33
01:00	0	14	5	0	0	1	0	0	0	0	0	0	0	20
02:00	0	17	3	0	2	0	0	0	2	0	0	0	0	24
03:00	0	17	1	0	1	1	0	0	0	0	0	0	0	20
04:00	1	38	8	0	0	1	0	0	4	0	0	0	0	52
05:00	2	90	25	0	0	3	0	0	3	0	0	0	0	123
06:00	1	237	63	1	5	4	0	4	7	0	0	0	0	322
07:00	9	403	114	1	17	<b>19</b>	<b>3</b>	5	<b>16</b>	2	0	0	<b>2</b>	591
08:00	14	481	<b>119</b>	<b>5</b>	15	6	0	6	7	<b>3</b>	<b>3</b>	0	2	<b>661</b>
09:00	<b>21</b>	480	89	2	13	8	2	5	9	1	1	0	2	633
10:00	18	494	88	2	<b>20</b>	5	1	<b>10</b>	14	0	0	0	1	653
11:00	9	<b>497</b>	71	4	13	13	3	7	12	2	0	<b>1</b>	1	633
12 PM	<b>19</b>	549	81	8	13	9	<b>3</b>	2	<b>16</b>	0	1	0	<b>2</b>	703
13:00	13	529	74	4	13	6	3	<b>7</b>	5	0	0	0	2	656
14:00	12	538	65	5	16	<b>17</b>	1	7	13	0	<b>2</b>	1	1	678
15:00	11	560	69	7	<b>19</b>	12	2	4	10	0	0	0	2	696
16:00	18	<b>721</b>	89	10	10	9	3	5	10	<b>2</b>	0	<b>2</b>	0	<b>879</b>
17:00	7	716	<b>100</b>	<b>16</b>	10	8	0	6	6	2	1	0	2	874
18:00	6	510	77	2	8	2	1	5	2	2	0	0	0	615
19:00	8	483	72	4	7	5	3	4	5	1	1	0	1	594
20:00	5	302	29	1	3	0	0	2	3	0	0	0	1	346
21:00	2	214	19	0	0	0	0	2	0	0	0	0	0	237
22:00	3	135	10	0	1	0	0	0	0	0	0	0	0	149
23:00	0	70	4	0	1	0	0	0	4	0	0	0	0	79
Day Total	179	8123	1279	72	187	129	25	81	149	15	9	4	19	10271
Percent	1.7%	79.1%	12.5%	0.7%	1.8%	1.3%	0.2%	0.8%	1.5%	0.1%	0.1%	0.0%	0.2%	
AM Peak	09:00	11:00	08:00	08:00	10:00	07:00	07:00	10:00	07:00	08:00	08:00	11:00	07:00	08:00
Vol.	21	497	119	5	20	19	3	10	16	3	3	1	2	661
PM Peak	12:00	16:00	17:00	17:00	15:00	14:00	12:00	13:00	12:00	16:00	14:00	16:00	12:00	16:00
Vol.	19	721	100	16	19	17	3	7	16	2	2	2	2	879
Grand Total	1044	46734	6820	343	904	637	114	410	761	48	38	17	55	57925
Percent	1.8%	80.7%	11.8%	0.6%	1.6%	1.1%	0.2%	0.7%	1.3%	0.1%	0.1%	0.0%	0.1%	



**All Traffic Data Services**  
www.alltrafficdata.net

Site Code: 5  
Station ID:  
US-160 W/O CR 232

WB

Start Time	Bikes	Cars & Trailers	2 Axle Long	Buses	2 Axle 6 Tire	3 Axle Single	4 Axle Single	<5 Axl Double	5 Axle Double	>6 Axl Double	<6 Axl Multi	6 Axle Multi	>6 Axl Multi	Total
09/27/18	0	18	1	0	1	0	0	0	0	0	0	0	0	20
01:00	0	20	2	0	0	1	0	0	0	0	0	0	0	23
02:00	1	16	2	0	0	0	0	0	0	0	0	0	0	19
03:00	1	28	3	0	0	0	1	0	2	0	0	0	0	35
04:00	7	51	4	0	1	0	0	0	2	<b>1</b>	0	0	0	66
05:00	18	191	5	0	2	1	0	4	4	0	0	0	0	225
06:00	35	481	51	0	3	7	4	1	5	0	0	0	0	587
07:00	<b>48</b>	<b>1076</b>	111	3	8	19	<b>14</b>	8	13	1	1	0	4	<b>1306</b>
08:00	33	756	115	<b>6</b>	<b>15</b>	16	2	8	11	0	<b>2</b>	0	5	969
09:00	23	641	131	0	13	<b>20</b>	2	<b>12</b>	12	0	2	0	3	859
10:00	23	626	125	1	15	18	2	9	7	0	1	0	<b>6</b>	833
11:00	14	602	<b>140</b>	1	13	12	3	8	<b>16</b>	0	0	0	4	813
12 PM	<b>29</b>	602	140	<b>5</b>	14	11	1	9	<b>18</b>	0	0	0	3	832
13:00	18	548	<b>154</b>	4	<b>16</b>	<b>23</b>	2	2	11	0	1	0	0	779
14:00	13	539	127	2	13	14	0	<b>14</b>	6	0	<b>3</b>	0	1	732
15:00	22	630	135	4	12	19	1	7	13	0	1	0	<b>5</b>	849
16:00	19	<b>765</b>	125	5	16	16	0	12	12	0	1	0	2	<b>973</b>
17:00	22	667	119	0	11	5	<b>4</b>	12	6	0	1	<b>1</b>	0	848
18:00	8	428	75	0	3	3	1	5	10	0	1	0	0	534
19:00	8	264	38	0	4	2	1	4	3	0	0	0	0	324
20:00	2	195	14	0	0	0	0	1	6	0	0	0	1	219
21:00	1	163	10	0	0	0	0	0	8	0	0	0	0	182
22:00	1	77	5	0	0	1	0	0	0	0	0	0	0	84
23:00	1	32	1	0	0	2	0	1	1	0	0	0	0	38
Day Total	347	9416	1633	31	160	190	38	117	166	2	14	1	34	12149
Percent	2.9%	77.5%	13.4%	0.3%	1.3%	1.6%	0.3%	1.0%	1.4%	0.0%	0.1%	0.0%	0.3%	
AM Peak	07:00	07:00	11:00	08:00	08:00	09:00	07:00	09:00	11:00	04:00	08:00		10:00	07:00
Vol.	48	1076	140	6	15	20	14	12	16	1	2		6	1306
PM Peak	12:00	16:00	13:00	12:00	13:00	13:00	17:00	14:00	12:00		14:00	17:00	15:00	16:00
Vol.	29	765	154	5	16	23	4	14	18		3	1	5	973

**All Traffic Data Services**  
www.alltrafficdata.net

Site Code: 5  
Station ID:  
US-160 W/O CR 232

WB

Start Time	Bikes	Cars & Trailers	2 Axle Long	Buses	2 Axle 6 Tire	3 Axle Single	4 Axle Single	<5 Axl Double	5 Axle Double	>6 Axl Double	<6 Axl Multi	6 Axle Multi	>6 Axl Multi	Total
09/28/18	0	22	4	0	0	1	0	0	1	0	0	0	0	28
01:00	0	20	0	0	2	0	0	0	1	0	0	0	0	23
02:00	0	19	1	0	0	0	0	0	0	0	0	0	0	20
03:00	0	28	2	0	0	0	0	0	1	0	0	0	0	31
04:00	3	62	6	1	1	0	0	1	2	0	0	0	0	76
05:00	8	152	9	0	2	1	0	1	1	1	0	0	0	175
06:00	24	407	37	1	3	1	2	3	5	0	0	0	2	485
07:00	<b>56</b>	<b>974</b>	134	<b>4</b>	14	18	4	11	<b>14</b>	1	2	0	<b>4</b>	<b>1236</b>
08:00	29	665	144	4	9	12	<b>7</b>	11	8	1	<b>3</b>	0	3	896
09:00	19	683	119	2	11	19	4	4	14	0	0	0	2	877
10:00	18	651	135	1	<b>15</b>	18	3	10	7	0	3	0	4	865
11:00	21	596	<b>192</b>	2	13	<b>20</b>	4	<b>15</b>	11	0	2	0	4	880
12 PM	<b>22</b>	534	<b>156</b>	<b>6</b>	<b>24</b>	10	1	10	6	0	1	0	0	770
13:00	21	590	130	0	14	14	<b>4</b>	<b>13</b>	<b>11</b>	0	2	0	<b>3</b>	802
14:00	20	683	135	2	15	<b>18</b>	2	6	10	<b>1</b>	2	0	1	<b>895</b>
15:00	22	647	126	2	15	10	4	8	8	0	<b>4</b>	0	0	846
16:00	19	<b>694</b>	137	1	8	12	4	5	9	0	4	0	2	895
17:00	14	644	143	0	12	6	1	7	5	0	2	0	2	836
18:00	9	468	75	2	3	3	0	2	7	0	0	0	1	570
19:00	7	311	48	0	0	0	1	1	5	0	0	0	0	373
20:00	2	263	22	1	2	0	0	1	4	1	0	0	1	297
21:00	3	193	19	3	5	1	0	0	1	0	0	0	1	226
22:00	1	121	10	0	1	1	0	0	3	0	0	0	0	137
23:00	1	68	2	0	1	0	0	0	2	0	0	0	0	74
Day Total	319	9495	1786	32	170	165	41	109	136	5	25	0	30	12313
Percent	2.6%	77.1%	14.5%	0.3%	1.4%	1.3%	0.3%	0.9%	1.1%	0.0%	0.2%	0.0%	0.2%	
AM Peak	07:00	07:00	11:00	07:00	10:00	11:00	08:00	11:00	07:00	05:00	08:00		07:00	07:00
Vol.	56	974	192	4	15	20	7	15	14	1	3		4	1236
PM Peak	12:00	16:00	12:00	12:00	12:00	14:00	13:00	13:00	13:00	14:00	15:00		13:00	14:00
Vol.	22	694	156	6	24	18	4	13	11	1	4		3	895

**All Traffic Data Services**  
www.alltrafficdata.net

Site Code: 5  
Station ID:  
US-160 W/O CR 232

WB

Start Time	Bikes	Cars & Trailers	2 Axle Long	Buses	2 Axle 6 Tire	3 Axle Single	4 Axle Single	<5 Axl Double	5 Axle Double	>6 Axl Double	<6 Axl Multi	6 Axle Multi	>6 Axl Multi	Total
09/29/18	0	42	2	0	0	0	0	1	3	0	0	0	0	48
01:00	0	34	1	0	0	0	0	0	0	0	0	0	0	35
02:00	0	28	4	0	0	0	0	0	0	0	0	0	0	32
03:00	2	24	1	0	0	0	0	0	2	0	0	0	0	29
04:00	3	40	2	0	0	0	0	0	3	0	0	0	0	48
05:00	0	98	9	2	2	0	0	1	2	0	0	0	1	115
06:00	8	176	7	0	3	0	1	1	3	0	0	0	0	199
07:00	16	340	33	1	3	3	2	0	4	0	1	0	0	403
08:00	17	491	86	1	<b>9</b>	5	<b>3</b>	3	2	0	1	0	1	619
09:00	19	561	117	1	9	<b>7</b>	3	7	4	0	1	<b>1</b>	<b>4</b>	734
10:00	<b>27</b>	587	<b>138</b>	2	4	7	1	<b>10</b>	<b>8</b>	0	1	0	0	785
11:00	15	<b>639</b>	137	<b>3</b>	9	3	2	9	7	0	<b>2</b>	0	1	<b>827</b>
12 PM	15	<b>592</b>	118	1	8	1	0	2	4	<b>1</b>	1	0	<b>2</b>	<b>745</b>
13:00	<b>17</b>	516	<b>136</b>	0	9	0	3	<b>8</b>	5	1	<b>3</b>	0	1	699
14:00	14	490	103	0	<b>10</b>	<b>5</b>	3	7	1	0	0	0	0	633
15:00	13	486	86	1	5	1	1	8	2	0	1	0	1	605
16:00	12	508	90	0	2	2	2	3	5	0	1	0	0	625
17:00	7	467	88	0	2	2	<b>4</b>	2	4	0	1	0	0	577
18:00	4	338	61	1	2	3	0	2	<b>6</b>	0	3	0	0	420
19:00	10	287	36	0	0	3	1	3	3	0	0	0	0	343
20:00	4	213	26	<b>2</b>	0	0	0	0	2	0	0	0	1	248
21:00	2	173	19	0	2	2	1	2	0	0	0	0	0	201
22:00	4	103	8	0	0	1	0	1	2	0	0	0	0	119
23:00	1	59	8	0	2	0	0	1	1	0	0	0	0	72
Day Total	210	7292	1316	15	81	45	27	71	73	2	16	1	12	9161
Percent	2.3%	79.6%	14.4%	0.2%	0.9%	0.5%	0.3%	0.8%	0.8%	0.0%	0.2%	0.0%	0.1%	
AM Peak	10:00	11:00	10:00	11:00	08:00	09:00	08:00	10:00	10:00		11:00	09:00	09:00	11:00
Vol.	27	639	138	3	9	7	3	10	8		2	1	4	827
PM Peak	13:00	12:00	13:00	20:00	14:00	14:00	17:00	13:00	18:00	12:00	13:00		12:00	12:00
Vol.	17	592	136	2	10	5	4	8	6	1	3		2	745

**All Traffic Data Services**  
www.alltrafficdata.net

Site Code: 5  
Station ID:  
US-160 W/O CR 232

WB

Start Time	Bikes	Cars & Trailers	2 Axle Long	Buses	2 Axle 6 Tire	3 Axle Single	4 Axle Single	<5 Axl Double	5 Axle Double	>6 Axl Double	<6 Axl Multi	6 Axle Multi	>6 Axl Multi	Total
09/30/18	0	38	1	0	2	0	0	0	0	0	0	0	0	41
01:00	1	33	3	0	0	0	0	0	0	0	0	0	0	37
02:00	0	28	1	0	0	0	0	0	0	0	0	0	0	29
03:00	1	17	0	1	1	0	0	0	1	0	0	0	0	21
04:00	2	31	3	0	0	0	0	0	1	0	0	0	0	37
05:00	1	54	5	0	1	0	0	0	1	0	0	0	0	62
06:00	5	123	4	1	0	0	1	0	0	0	0	0	0	134
07:00	13	209	25	1	0	1	2	1	0	0	0	0	0	252
08:00	13	387	61	1	1	1	1	1	4	1	1	0	0	472
09:00	17	480	96	0	5	6	3	5	2	0	1	0	0	615
10:00	16	565	116	1	8	2	0	10	3	1	2	0	2	726
11:00	22	497	117	0	6	5	0	6	6	0	1	0	0	660
12 PM	7	520	104	1	4	3	2	5	5	0	1	0	1	653
13:00	21	488	96	0	6	1	3	6	2	0	0	0	1	624
14:00	14	469	87	0	3	1	1	5	4	1	4	0	0	589
15:00	15	478	76	0	3	2	4	3	2	0	2	0	0	585
16:00	8	422	72	0	7	7	0	4	0	0	1	0	1	522
17:00	13	404	81	2	4	0	1	6	4	0	0	0	0	515
18:00	13	335	57	0	2	1	0	1	3	0	0	0	0	412
19:00	8	224	42	0	1	0	0	4	4	0	0	0	0	283
20:00	2	175	27	0	0	0	0	1	3	0	0	0	1	209
21:00	3	136	14	0	1	1	1	1	6	0	0	0	0	163
22:00	5	65	8	1	1	0	0	0	2	0	0	0	0	82
23:00	0	39	2	2	2	2	0	0	0	0	0	0	0	47
Day Total	200	6217	1098	11	58	33	19	59	53	3	13	0	6	7770
Percent	2.6%	80.0%	14.1%	0.1%	0.7%	0.4%	0.2%	0.8%	0.7%	0.0%	0.2%	0.0%	0.1%	
AM Peak	11:00	10:00	11:00	03:00	10:00	09:00	09:00	10:00	11:00	08:00	10:00		10:00	10:00
Vol.	22	565	117	1	8	6	3	10	6	1	2		2	726
PM Peak	13:00	12:00	12:00	17:00	16:00	16:00	15:00	13:00	21:00	14:00	14:00		12:00	12:00
Vol.	21	520	104	2	7	7	4	6	6	1	4		1	653

**All Traffic Data Services**  
www.alltrafficdata.net

Site Code: 5  
Station ID:  
US-160 W/O CR 232

WB

Start Time	Bikes	Cars & Trailers	2 Axle Long	Buses	2 Axle 6 Tire	3 Axle Single	4 Axle Single	<5 Axl Double	5 Axle Double	>6 Axl Double	<6 Axl Multi	6 Axle Multi	>6 Axl Multi	Total
10/01/18	3	15	2	0	2	0	0	0	1	0	0	0	0	23
01:00	0	21	1	0	0	0	0	0	3	0	0	0	0	25
02:00	0	16	1	0	0	0	0	0	0	0	0	0	0	17
03:00	0	31	0	0	0	0	0	0	3	0	0	0	0	34
04:00	2	49	5	0	1	0	0	0	2	0	0	0	0	59
05:00	1	171	16	0	0	3	2	1	4	0	0	0	1	199
06:00	9	421	95	0	9	7	3	4	4	0	0	0	1	553
07:00	32	<b>930</b>	<b>169</b>	2	8	8	<b>10</b>	<b>14</b>	12	0	<b>1</b>	0	<b>4</b>	<b>1190</b>
08:00	<b>41</b>	814	143	2	7	13	6	11	8	<b>1</b>	1	0	1	1048
09:00	20	682	125	2	7	12	3	2	17	0	1	0	0	871
10:00	12	667	109	<b>3</b>	<b>14</b>	<b>16</b>	2	8	<b>18</b>	1	1	0	4	855
11:00	14	629	123	2	10	15	2	8	7	1	0	0	2	813
12 PM	20	635	116	<b>3</b>	12	15	1	11	16	0	<b>2</b>	0	<b>3</b>	834
13:00	<b>22</b>	582	113	2	<b>19</b>	<b>17</b>	<b>3</b>	6	<b>29</b>	0	2	0	2	797
14:00	17	581	<b>129</b>	2	15	12	2	4	15	0	1	0	0	778
15:00	12	623	121	3	15	12	2	<b>14</b>	13	0	1	1	2	819
16:00	14	<b>738</b>	104	1	6	9	3	7	10	0	0	0	2	<b>894</b>
17:00	11	688	102	0	10	9	2	3	9	<b>1</b>	2	<b>2</b>	1	840
18:00	7	373	48	0	1	8	1	3	4	0	0	0	0	445
19:00	2	206	22	0	0	2	0	3	5	0	0	0	0	240
20:00	3	142	15	0	2	1	0	2	5	0	0	0	0	170
21:00	3	147	6	3	4	1	0	0	6	0	0	0	0	170
22:00	1	65	2	0	0	0	0	0	3	0	0	0	0	71
23:00	0	34	1	0	0	0	0	0	0	0	0	0	0	35
Day Total	246	9260	1568	25	142	160	42	101	194	4	12	3	23	11780
Percent	2.1%	78.6%	13.3%	0.2%	1.2%	1.4%	0.4%	0.9%	1.6%	0.0%	0.1%	0.0%	0.2%	
AM Peak	08:00	07:00	07:00	10:00	10:00	10:00	07:00	07:00	10:00	08:00	07:00		07:00	07:00
Vol.	41	930	169	3	14	16	10	14	18	1	1		4	1190
PM Peak	13:00	16:00	14:00	12:00	13:00	13:00	13:00	15:00	13:00	17:00	12:00	17:00	12:00	16:00
Vol.	22	738	129	3	19	17	3	14	29	1	2	2	3	894



**All Traffic Data Services**  
www.alltrafficdata.net

Site Code: 5  
Station ID:  
US-160 W/O CR 232

WB

Start Time	Bikes	Cars & Trailers	2 Axle Long	Buses	2 Axle 6 Tire	3 Axle Single	4 Axle Single	<5 Axl Double	5 Axle Double	>6 Axl Double	<6 Axl Multi	6 Axle Multi	>6 Axl Multi	Total
10/02/18	0	22	2	0	0	0	0	0	1	0	0	0	0	25
01:00	0	11	1	0	0	0	0	0	1	0	0	0	0	13
02:00	0	16	2	0	0	0	0	0	2	0	0	0	0	20
03:00	0	38	1	0	0	3	0	1	0	0	0	0	0	43
04:00	2	47	6	0	0	0	0	0	3	0	0	0	0	58
05:00	2	179	19	0	2	3	0	2	4	0	0	0	0	211
06:00	17	468	86	0	3	6	3	1	6	0	0	0	2	592
07:00	<b>32</b>	<b>999</b>	138	2	7	14	<b>8</b>	6	11	<b>1</b>	0	0	1	<b>1219</b>
08:00	23	846	137	3	<b>17</b>	15	8	<b>10</b>	9	0	1	0	2	1071
09:00	20	670	121	0	13	<b>21</b>	5	7	<b>17</b>	0	1	0	1	876
10:00	17	658	122	0	9	15	2	6	16	0	<b>4</b>	<b>1</b>	1	851
11:00	16	611	<b>149</b>	<b>4</b>	14	18	1	7	10	0	2	0	<b>4</b>	836
12 PM	15	601	129	0	10	9	4	<b>13</b>	<b>17</b>	0	<b>3</b>	0	<b>3</b>	804
13:00	16	511	125	0	10	<b>19</b>	<b>6</b>	5	9	<b>2</b>	0	0	2	705
14:00	<b>17</b>	622	134	<b>2</b>	<b>18</b>	18	4	4	6	1	1	0	3	830
15:00	13	628	134	0	17	11	6	8	8	0	2	0	0	827
16:00	16	<b>677</b>	<b>149</b>	1	13	7	1	8	13	0	2	0	1	<b>888</b>
17:00	11	666	116	1	9	6	3	8	9	0	0	0	2	831
18:00	3	354	41	2	6	1	2	1	5	0	0	0	0	415
19:00	6	251	21	0	2	3	0	2	3	0	0	0	0	288
20:00	4	172	18	0	1	0	0	1	5	0	0	0	0	201
21:00	3	129	12	0	1	3	0	1	5	0	0	0	0	154
22:00	2	69	3	0	1	1	0	1	4	0	0	0	0	81
23:00	0	37	1	0	0	0	0	1	1	0	0	0	0	40
Day Total	235	9282	1667	15	153	173	53	93	165	4	16	1	22	11879
Percent	2.0%	78.1%	14.0%	0.1%	1.3%	1.5%	0.4%	0.8%	1.4%	0.0%	0.1%	0.0%	0.2%	
AM Peak	07:00	07:00	11:00	11:00	08:00	09:00	07:00	08:00	09:00	07:00	10:00	10:00	11:00	07:00
Vol.	32	999	149	4	17	21	8	10	17	1	4	1	4	1219
PM Peak	14:00	16:00	16:00	14:00	14:00	13:00	13:00	12:00	12:00	13:00	12:00		12:00	16:00
Vol.	17	677	149	2	18	19	6	13	17	2	3		3	888

**All Traffic Data Services**  
www.alltrafficdata.net

Site Code: 5  
Station ID:  
US-160 W/O CR 232

WB	Start Time	Bikes	Cars & Trailers	2 Axle Long	Buses	2 Axle 6 Tire	3 Axle Single	4 Axle Single	<5 Axl Double	5 Axle Double	>6 Axl Double	<6 Axl Multi	6 Axle Multi	>6 Axl Multi	Total
	10/03/18	0	20	1	1	2	0	0	0	1	0	0	0	0	25
	01:00	1	19	1	0	1	0	0	0	1	0	0	0	0	23
	02:00	0	16	2	0	0	0	0	0	0	0	0	0	0	18
	03:00	2	27	4	0	0	0	0	0	1	0	0	0	0	34
	04:00	1	49	4	0	0	0	0	1	1	0	0	0	0	56
	05:00	2	174	17	0	3	0	0	2	0	0	0	0	0	198
	06:00	5	491	91	0	3	5	1	3	4	0	2	0	1	606
	07:00	<b>33</b>	<b>1044</b>	147	<b>4</b>	3	14	<b>6</b>	<b>14</b>	13	<b>1</b>	0	0	<b>6</b>	<b>1285</b>
	08:00	27	730	<b>154</b>	3	15	<b>18</b>	6	10	12	1	2	0	2	980
	09:00	19	688	126	2	14	11	6	5	16	0	2	0	5	894
	10:00	21	613	114	1	<b>17</b>	9	4	1	<b>21</b>	0	2	0	2	805
	11:00	18	655	153	2	14	14	3	9	6	1	<b>3</b>	0	4	882
	12 PM	<b>21</b>	602	160	<b>2</b>	16	12	1	5	13	<b>1</b>	<b>2</b>	0	2	837
	13:00	18	565	128	2	15	18	2	<b>9</b>	<b>17</b>	1	1	0	0	776
	14:00	16	568	157	2	<b>22</b>	13	1	9	7	0	2	0	1	798
	15:00	17	632	<b>169</b>	2	17	<b>19</b>	1	9	6	1	1	0	2	876
	16:00	18	<b>693</b>	166	2	12	11	<b>6</b>	5	5	0	0	0	<b>5</b>	<b>923</b>
	17:00	9	659	130	1	10	11	2	5	7	0	0	0	1	835
	18:00	16	442	67	0	7	2	1	4	2	0	2	0	2	545
	19:00	1	239	22	0	3	3	1	3	3	0	0	0	0	275
	20:00	2	154	17	1	1	2	1	2	9	0	0	0	0	189
	21:00	3	176	13	0	0	1	1	0	3	0	0	0	0	197
	22:00	3	66	5	0	1	0	0	1	4	0	0	0	0	80
	23:00	1	50	2	0	0	1	0	0	4	0	0	0	0	58
	Day Total	254	9372	1850	25	176	164	43	97	156	6	19	0	33	12195
	Percent	2.1%	76.9%	15.2%	0.2%	1.4%	1.3%	0.4%	0.8%	1.3%	0.0%	0.2%	0.0%	0.3%	
	AM Peak	07:00	07:00	08:00	07:00	10:00	08:00	07:00	07:00	10:00	07:00	11:00		07:00	07:00
	Vol.	33	1044	154	4	17	18	6	14	21	1	3		6	1285
	PM Peak	12:00	16:00	15:00	12:00	14:00	15:00	16:00	13:00	13:00	12:00	12:00		16:00	16:00
	Vol.	21	693	169	2	22	19	6	9	17	1	2		5	923
	Grand Total	1811	60334	10918	154	940	930	263	647	943	26	115	6	160	77247
	Percent	2.3%	78.1%	14.1%	0.2%	1.2%	1.2%	0.3%	0.8%	1.2%	0.0%	0.1%	0.0%	0.2%	

**All Traffic Data Services**  
www.alltrafficdata.net

Site Code: 6  
Station ID:  
US-550 S/O US-160

NB

Start Time	Bikes	Cars & Trailers	2 Axle Long	Buses	2 Axle 6 Tire	3 Axle Single	4 Axle Single	<5 Axl Double	5 Axle Double	>6 Axl Double	<6 Axl Multi	6 Axle Multi	>6 Axl Multi	Total
09/27/18	0	8	2	0	1	0	0	0	1	0	0	0	0	12
01:00	0	2	0	0	0	1	0	0	2	0	0	0	0	5
02:00	0	6	1	0	0	0	0	0	2	0	0	0	0	9
03:00	0	16	3	0	0	0	0	1	2	0	0	0	0	22
04:00	1	14	4	0	0	0	0	0	2	0	0	0	0	21
05:00	0	74	17	0	0	0	0	1	6	0	0	0	0	98
06:00	2	199	76	1	3	3	0	2	6	0	0	0	0	292
07:00	7	<b>345</b>	<b>87</b>	1	6	3	0	3	<b>9</b>	<b>2</b>	0	0	0	<b>463</b>
08:00	3	309	57	1	1	6	0	4	4	0	0	0	0	385
09:00	<b>8</b>	231	61	0	<b>17</b>	3	0	2	2	0	0	0	0	324
10:00	5	227	57	1	6	<b>7</b>	0	3	6	1	0	0	<b>1</b>	314
11:00	8	189	49	0	7	7	<b>1</b>	1	3	0	<b>1</b>	0	0	266
12 PM	3	204	44	1	4	<b>7</b>	0	2	4	0	0	0	0	269
13:00	8	232	49	1	5	4	0	2	<b>8</b>	0	0	0	0	309
14:00	<b>9</b>	<b>245</b>	48	<b>2</b>	1	5	0	1	3	0	0	0	<b>1</b>	<b>315</b>
15:00	7	222	<b>54</b>	0	<b>11</b>	3	0	<b>3</b>	3	0	0	0	0	303
16:00	7	238	52	0	4	3	0	1	3	0	0	0	0	308
17:00	8	172	33	1	2	3	0	0	1	0	<b>1</b>	0	1	222
18:00	5	174	26	1	0	1	0	0	2	0	0	0	0	209
19:00	1	104	25	1	0	1	0	1	3	0	0	0	0	136
20:00	2	94	12	0	2	0	0	0	1	0	0	0	0	111
21:00	0	49	13	0	0	0	0	2	3	0	0	0	0	67
22:00	0	23	3	0	0	0	0	0	0	0	0	0	0	26
23:00	1	18	2	0	1	0	0	0	1	0	0	0	0	23
Day Total	85	3395	775	11	71	57	1	29	77	3	2	0	3	4509
Percent	1.9%	75.3%	17.2%	0.2%	1.6%	1.3%	0.0%	0.6%	1.7%	0.1%	0.0%	0.0%	0.1%	
AM Peak	09:00	07:00	07:00	06:00	09:00	10:00	11:00	08:00	07:00	07:00	11:00		10:00	07:00
Vol.	8	345	87	1	17	7	1	4	9	2	1		1	463
PM Peak	14:00	14:00	15:00	14:00	15:00	12:00		15:00	13:00		17:00		14:00	14:00
Vol.	9	245	54	2	11	7		3	8		1		1	315

**All Traffic Data Services**  
www.alltrafficdata.net

Site Code: 6  
Station ID:  
US-550 S/O US-160

NB

Start Time	Bikes	Cars & Trailers	2 Axle Long	Buses	2 Axle 6 Tire	3 Axle Single	4 Axle Single	<5 Axl Double	5 Axle Double	>6 Axl Double	<6 Axl Multi	6 Axle Multi	>6 Axl Multi	Total
09/28/18	0	6	1	0	0	0	0	0	1	0	0	0	0	8
01:00	0	8	1	0	0	0	0	0	2	0	0	0	0	11
02:00	1	8	1	0	0	0	0	0	1	0	0	0	0	11
03:00	0	14	1	0	2	0	0	1	4	0	0	0	0	22
04:00	0	12	7	0	0	0	0	0	3	0	0	0	0	22
05:00	0	69	14	0	0	0	0	4	8	0	0	0	0	95
06:00	2	195	32	1	4	2	0	<b>9</b>	5	0	0	0	1	251
07:00	8	<b>377</b>	<b>67</b>	0	4	3	0	4	5	0	0	0	<b>2</b>	<b>470</b>
08:00	10	310	54	1	<b>8</b>	<b>5</b>	0	1	7	0	0	0	0	396
09:00	7	263	51	0	6	1	0	3	5	0	0	0	0	336
10:00	7	251	52	<b>3</b>	5	2	0	5	<b>9</b>	0	0	0	0	334
11:00	<b>15</b>	228	65	0	4	4	0	2	4	0	0	0	1	323
12 PM	7	254	51	0	2	<b>7</b>	<b>1</b>	1	<b>6</b>	<b>1</b>	0	0	<b>2</b>	332
13:00	7	262	45	0	1	6	0	1	4	0	0	0	0	326
14:00	<b>15</b>	262	61	<b>1</b>	2	3	0	1	3	0	0	0	1	<b>349</b>
15:00	7	235	52	0	<b>5</b>	6	0	2	1	0	0	0	0	308
16:00	12	<b>271</b>	49	0	1	5	0	2	4	0	0	0	0	344
17:00	9	242	<b>63</b>	1	4	0	0	<b>3</b>	0	0	0	0	0	322
18:00	2	219	35	0	4	0	0	0	0	0	0	0	0	260
19:00	5	132	18	1	0	0	0	0	2	0	0	0	0	158
20:00	0	120	6	0	0	0	0	0	2	0	0	0	0	128
21:00	1	94	10	0	1	0	0	1	1	0	0	0	0	108
22:00	0	56	2	0	1	0	0	0	1	0	0	0	0	60
23:00	0	26	1	0	1	0	0	1	0	0	0	0	0	29
Day Total	115	3914	739	8	55	44	1	41	78	1	0	0	7	5003
Percent	2.3%	78.2%	14.8%	0.2%	1.1%	0.9%	0.0%	0.8%	1.6%	0.0%	0.0%	0.0%	0.1%	
AM Peak	11:00	07:00	07:00	10:00	08:00	08:00		06:00	10:00				07:00	07:00
Vol.	15	377	67	3	8	5		9	9				2	470
PM Peak	14:00	16:00	17:00	14:00	15:00	12:00	12:00	17:00	12:00	12:00			12:00	14:00
Vol.	15	271	63	1	5	7	1	3	6	1			2	349

**All Traffic Data Services**  
www.alltrafficdata.net

Site Code: 6  
Station ID:  
US-550 S/O US-160

NB

Start Time	Bikes	Cars & Trailers	2 Axle Long	Buses	2 Axle 6 Tire	3 Axle Single	4 Axle Single	<5 Axl Double	5 Axle Double	>6 Axl Double	<6 Axl Multi	6 Axle Multi	>6 Axl Multi	Total
09/29/18	0	13	1	0	0	0	0	0	0	0	0	0	0	14
01:00	0	6	4	0	1	0	0	0	2	0	0	0	0	13
02:00	0	6	0	0	0	0	0	0	2	0	0	0	0	8
03:00	0	11	0	0	0	1	0	0	2	0	0	0	0	14
04:00	0	25	1	0	1	0	0	0	1	0	0	0	0	28
05:00	0	34	3	0	0	0	0	0	3	0	0	0	0	40
06:00	2	78	11	1	1	1	0	1	4	0	0	0	0	99
07:00	4	170	27	0	0	0	0	1	1	0	0	0	1	204
08:00	10	265	49	0	0	1	0	0	0	0	0	0	0	325
09:00	7	264	29	0	2	1	0	2	0	0	0	0	0	305
10:00	12	284	39	1	3	2	0	0	1	0	0	0	0	342
11:00	15	277	40	0	1	3	0	2	0	0	0	0	0	338
12 PM	14	279	34	0	3	1	0	2	3	0	0	0	0	336
13:00	13	257	37	0	3	2	0	1	4	0	0	0	0	317
14:00	13	275	29	0	1	0	0	0	1	0	0	0	0	319
15:00	13	307	33	0	1	0	0	3	3	0	0	0	0	360
16:00	13	244	34	0	3	0	0	1	2	0	0	0	0	297
17:00	6	235	18	0	0	1	0	0	2	0	0	0	0	262
18:00	6	205	21	0	0	1	0	0	0	0	0	0	1	234
19:00	0	146	12	0	1	0	0	0	3	0	0	0	0	162
20:00	0	118	10	0	0	0	0	0	2	0	0	0	0	130
21:00	0	88	8	0	0	0	0	0	1	0	0	0	0	97
22:00	0	48	1	0	0	0	0	0	0	0	0	0	0	49
23:00	1	31	5	0	0	0	0	0	1	0	0	0	0	38
Day Total	129	3666	446	2	21	14	0	13	38	0	0	0	2	4331
Percent	3.0%	84.6%	10.3%	0.0%	0.5%	0.3%	0.0%	0.3%	0.9%	0.0%	0.0%	0.0%	0.0%	
AM Peak	11:00	10:00	08:00	06:00	10:00	11:00		09:00	06:00				07:00	10:00
Vol.	15	284	49	1	3	3		2	4				1	342
PM Peak	12:00	15:00	13:00		12:00	13:00		15:00	13:00				18:00	15:00
Vol.	14	307	37		3	2		3	4				1	360

**All Traffic Data Services**  
www.alltrafficdata.net

Site Code: 6  
Station ID:  
US-550 S/O US-160

NB

Start Time	Bikes	Cars & Trailers	2 Axle Long	Buses	2 Axle 6 Tire	3 Axle Single	4 Axle Single	<5 Axl Double	5 Axle Double	>6 Axl Double	<6 Axl Multi	6 Axle Multi	>6 Axl Multi	Total
09/30/18	1	18	1	0	0	0	0	0	1	0	0	0	0	21
01:00	0	6	0	0	0	0	0	0	3	0	0	0	0	9
02:00	0	5	0	0	0	0	0	0	0	0	0	0	0	5
03:00	0	8	0	0	0	0	0	0	2	0	0	0	0	10
04:00	0	10	0	0	0	0	1	0	2	0	0	0	0	13
05:00	0	26	2	0	0	0	0	0	3	0	0	0	0	31
06:00	0	45	6	0	0	1	0	0	3	0	0	0	0	55
07:00	1	85	5	1	1	0	0	1	2	0	0	0	0	96
08:00	6	163	25	0	1	0	0	2	4	0	0	0	0	201
09:00	6	192	23	1	0	1	0	0	1	0	0	0	0	224
10:00	12	243	36	0	0	0	0	2	2	0	0	0	0	295
11:00	10	<b>266</b>	<b>42</b>	1	0	1	0	3	1	0	0	0	0	<b>324</b>
12 PM	<b>18</b>	222	17	0	3	0	0	3	3	0	0	0	1	267
13:00	15	246	<b>23</b>	1	2	2	0	0	1	0	0	0	0	<b>290</b>
14:00	4	215	20	0	0	1	0	3	3	0	0	0	0	246
15:00	11	<b>248</b>	21	2	3	0	0	2	1	0	0	0	0	288
16:00	2	207	22	0	0	0	0	0	1	0	0	0	1	233
17:00	2	184	21	0	0	0	0	1	2	0	0	0	0	210
18:00	0	143	13	2	1	1	0	3	2	0	0	0	0	165
19:00	5	140	6	0	0	0	0	0	1	0	0	0	0	152
20:00	0	100	8	0	0	0	0	0	0	0	0	0	0	108
21:00	0	53	3	0	0	0	0	1	0	0	0	0	0	57
22:00	1	30	5	0	0	0	0	1	1	0	0	0	0	38
23:00	1	14	1	0	0	0	0	0	0	0	0	0	0	16
Day Total	95	2869	300	8	11	7	1	22	39	0	0	0	2	3354
Percent	2.8%	85.5%	8.9%	0.2%	0.3%	0.2%	0.0%	0.7%	1.2%	0.0%	0.0%	0.0%	0.1%	
AM Peak	10:00	11:00	11:00	07:00	07:00	06:00	04:00	11:00	08:00					11:00
Vol.	12	266	42	1	1	1	1	3	4					324
PM Peak	12:00	15:00	13:00	15:00	12:00	13:00		12:00	12:00				12:00	13:00
Vol.	18	248	23	2	3	2		3	3				1	290



**All Traffic Data Services**  
www.alltrafficdata.net

Site Code: 6  
Station ID:  
US-550 S/O US-160

**NB**

Start Time	Bikes	Cars & Trailers	2 Axle Long	Buses	2 Axle 6 Tire	3 Axle Single	4 Axle Single	<5 Axl Double	5 Axle Double	>6 Axl Double	<6 Axl Multi	6 Axle Multi	>6 Axl Multi	Total
10/01/18	0	10	0	0	0	0	0	0	1	0	0	0	0	11
01:00	0	10	0	0	1	0	0	0	3	0	0	0	0	14
02:00	0	8	0	0	0	0	0	1	2	0	0	0	0	11
03:00	0	19	3	0	0	0	0	0	3	0	0	0	0	25
04:00	0	15	2	0	0	0	0	0	4	0	0	0	0	21
05:00	1	75	7	0	0	2	0	1	3	0	0	0	0	89
06:00	4	217	43	0	0	4	0	5	4	0	0	0	0	277
07:00	6	<b>351</b>	43	2	1	4	0	<b>6</b>	8	0	0	0	0	<b>421</b>
08:00	5	318	<b>51</b>	1	<b>6</b>	<b>9</b>	0	2	6	0	0	0	0	398
09:00	<b>7</b>	234	34	0	3	2	0	3	<b>9</b>	0	0	0	0	292
10:00	6	226	40	<b>3</b>	3	4	0	6	8	0	0	0	0	296
11:00	7	214	29	2	4	2	0	3	3	0	0	0	0	264
12 PM	6	224	<b>52</b>	0	6	<b>6</b>	0	1	2	0	0	0	0	297
13:00	5	207	33	0	1	4	0	0	<b>8</b>	0	0	0	<b>1</b>	259
14:00	4	<b>243</b>	27	<b>2</b>	<b>10</b>	4	0	<b>5</b>	1	0	<b>1</b>	0	<b>1</b>	<b>298</b>
15:00	<b>7</b>	242	28	0	4	4	0	3	4	0	0	0	0	292
16:00	4	203	47	0	3	4	0	2	2	0	0	0	0	265
17:00	5	219	36	0	0	1	0	0	2	0	0	0	0	263
18:00	1	130	14	0	1	0	<b>1</b>	1	5	0	0	0	0	153
19:00	1	86	12	0	0	1	0	0	3	0	0	0	0	103
20:00	0	57	6	0	0	2	0	0	1	0	0	0	0	66
21:00	0	44	6	0	0	0	0	1	0	0	0	0	0	51
22:00	1	12	1	0	1	0	0	0	1	0	0	0	0	16
23:00	0	13	2	0	0	0	0	0	0	0	0	0	0	15
Day Total	70	3377	516	10	44	53	1	40	83	0	1	0	2	4197
Percent	1.7%	80.5%	12.3%	0.2%	1.0%	1.3%	0.0%	1.0%	2.0%	0.0%	0.0%	0.0%	0.0%	
AM Peak	09:00	07:00	08:00	10:00	08:00	08:00		07:00	09:00					07:00
Vol.	7	351	51	3	6	9		6	9					421
PM Peak	15:00	14:00	12:00	14:00	14:00	12:00	18:00	14:00	13:00		14:00		13:00	14:00
Vol.	7	243	52	2	10	6	1	5	8		1		1	298

**All Traffic Data Services**  
www.alltrafficdata.net

Site Code: 6  
Station ID:  
US-550 S/O US-160

NB

Start Time	Bikes	Cars & Trailers	2 Axle Long	Buses	2 Axle 6 Tire	3 Axle Single	4 Axle Single	<5 Axl Double	5 Axle Double	>6 Axl Double	<6 Axl Multi	6 Axle Multi	>6 Axl Multi	Total
10/02/18	0	7	1	0	0	0	0	0	2	0	0	0	0	10
01:00	0	6	0	0	0	0	0	0	2	0	0	0	0	8
02:00	0	5	0	0	0	0	0	0	2	0	0	0	0	7
03:00	0	13	4	0	0	0	0	0	1	0	0	0	0	18
04:00	0	21	7	0	1	0	0	0	1	0	0	0	0	30
05:00	0	62	18	0	1	0	0	2	<b>9</b>	0	0	0	0	92
06:00	3	199	67	1	1	6	0	0	4	0	0	0	0	281
07:00	<b>12</b>	<b>333</b>	<b>97</b>	<b>7</b>	8	2	0	<b>9</b>	3	0	0	0	<b>3</b>	<b>474</b>
08:00	4	285	61	1	7	<b>8</b>	<b>1</b>	2	4	0	0	<b>1</b>	1	375
09:00	4	214	59	2	4	8	0	2	3	0	0	0	0	296
10:00	2	196	69	1	<b>10</b>	0	0	2	6	0	0	0	1	287
11:00	8	189	48	2	7	5	0	1	4	0	0	0	0	264
12 PM	2	166	58	0	5	7	0	<b>2</b>	3	0	0	0	0	243
13:00	5	187	<b>63</b>	0	4	<b>9</b>	<b>1</b>	1	5	0	0	0	0	275
14:00	3	199	56	0	8	4	0	2	6	0	<b>1</b>	0	0	<b>279</b>
15:00	4	179	51	<b>2</b>	<b>12</b>	2	0	2	<b>7</b>	0	0	0	0	259
16:00	<b>6</b>	<b>213</b>	42	0	6	1	0	1	3	0	1	0	0	273
17:00	2	191	50	0	2	4	0	0	3	0	0	0	0	252
18:00	2	134	22	1	0	1	0	0	3	0	0	0	0	163
19:00	0	92	10	0	0	0	0	0	1	0	0	0	0	103
20:00	0	55	8	0	0	0	0	1	2	0	0	0	0	66
21:00	0	38	4	0	0	0	0	2	1	0	0	0	0	45
22:00	0	24	2	0	0	1	0	0	2	0	0	0	0	29
23:00	0	19	2	0	0	0	0	1	1	0	0	0	0	23
Day Total	57	3027	799	17	76	58	2	30	78	0	2	1	5	4152
Percent	1.4%	72.9%	19.2%	0.4%	1.8%	1.4%	0.0%	0.7%	1.9%	0.0%	0.0%	0.0%	0.1%	
AM Peak	07:00	07:00	07:00	07:00	10:00	08:00	08:00	07:00	05:00			08:00	07:00	07:00
Vol.	12	333	97	7	10	8	1	9	9			1	3	474
PM Peak	16:00	16:00	13:00	15:00	15:00	13:00	13:00	12:00	15:00		14:00			14:00
Vol.	6	213	63	2	12	9	1	2	7		1			279

**All Traffic Data Services**  
www.alltrafficdata.net

Site Code: 6  
Station ID:  
US-550 S/O US-160

**NB**

Start Time	Bikes	Cars & Trailers	2 Axle Long	Buses	2 Axle 6 Tire	3 Axle Single	4 Axle Single	<5 Axl Double	5 Axle Double	>6 Axl Double	<6 Axl Multi	6 Axle Multi	>6 Axl Multi	Total
10/03/18	0	12	2	0	0	1	0	0	0	0	0	0	0	15
01:00	0	5	0	0	1	0	0	0	3	0	0	0	0	9
02:00	0	5	0	0	1	0	0	2	0	0	0	0	0	8
03:00	0	10	2	0	0	0	0	0	3	0	0	0	0	15
04:00	0	22	9	0	1	0	0	0	3	0	0	0	0	35
05:00	1	80	4	0	1	1	0	0	4	0	1	0	0	92
06:00	2	222	62	1	2	2	0	4	7	0	0	0	0	302
07:00	5	<b>327</b>	82	<b>8</b>	6	5	0	<b>8</b>	6	<b>1</b>	0	0	0	<b>448</b>
08:00	<b>7</b>	260	<b>90</b>	6	<b>13</b>	<b>8</b>	<b>2</b>	2	6	0	0	0	0	394
09:00	2	217	61	2	11	6	1	2	<b>9</b>	0	0	0	0	311
10:00	5	230	61	0	9	5	0	4	8	0	0	0	0	322
11:00	5	207	46	2	1	8	0	0	3	0	0	0	0	272
12 PM	4	198	31	<b>1</b>	4	3	0	1	<b>7</b>	0	0	0	0	249
13:00	5	211	40	1	2	3	0	2	3	<b>1</b>	0	0	0	268
14:00	5	207	44	0	4	1	0	<b>4</b>	4	0	0	0	<b>2</b>	271
15:00	7	201	<b>60</b>	0	<b>7</b>	<b>6</b>	0	4	4	0	0	<b>1</b>	0	<b>290</b>
16:00	<b>10</b>	200	46	0	3	3	0	2	7	0	0	0	0	271
17:00	8	<b>220</b>	53	0	5	1	0	1	1	0	0	0	1	290
18:00	1	151	30	0	1	0	0	1	1	0	0	0	0	185
19:00	1	114	22	0	2	0	0	0	0	0	0	0	0	139
20:00	3	66	9	0	2	0	0	0	0	0	0	0	0	80
21:00	1	39	12	1	1	0	0	1	1	0	0	0	0	56
22:00	0	23	5	0	0	0	0	0	2	0	0	0	0	30
23:00	0	13	3	0	0	0	0	1	1	0	0	0	0	18
Day Total	72	3240	774	22	77	53	3	39	83	2	1	1	3	4370
Percent	1.6%	74.1%	17.7%	0.5%	1.8%	1.2%	0.1%	0.9%	1.9%	0.0%	0.0%	0.0%	0.1%	
AM Peak	08:00	07:00	08:00	07:00	08:00	08:00	08:00	07:00	09:00	07:00	05:00			07:00
Vol.	7	327	90	8	13	8	2	8	9	1	1			448
PM Peak	16:00	17:00	15:00	12:00	15:00	15:00		14:00	12:00	13:00		15:00	14:00	15:00
Vol.	10	220	60	1	7	6		4	7	1		1	2	290
Grand Total	623	23488	4349	78	355	286	9	214	476	6	6	2	24	29916
Percent	2.1%	78.5%	14.5%	0.3%	1.2%	1.0%	0.0%	0.7%	1.6%	0.0%	0.0%	0.0%	0.1%	

**All Traffic Data Services**  
www.alltrafficdata.net

Site Code: 6  
Station ID:  
US-550 S/O US-160

SB

Start Time	Bikes	Cars & Trailers	2 Axle Long	Buses	2 Axle 6 Tire	3 Axle Single	4 Axle Single	<5 Axl Double	5 Axle Double	>6 Axl Double	<6 Axl Multi	6 Axle Multi	>6 Axl Multi	Total
09/27/18	0	10	1	<b>1</b>	2	0	0	0	0	0	0	0	0	14
01:00	1	7	0	0	0	1	0	0	0	0	0	0	0	9
02:00	0	4	1	0	0	0	0	0	0	0	0	0	0	5
03:00	1	5	1	0	0	1	0	1	2	0	0	0	0	11
04:00	1	17	2	0	1	1	0	1	2	0	0	0	0	25
05:00	3	34	2	0	0	2	0	1	3	0	0	0	0	45
06:00	1	98	17	0	2	0	0	1	3	0	0	0	0	122
07:00	6	145	18	1	2	2	0	1	2	0	0	0	0	177
08:00	7	203	27	0	4	<b>7</b>	0	0	4	0	0	0	0	252
09:00	<b>9</b>	168	<b>37</b>	0	<b>7</b>	6	0	<b>6</b>	5	0	0	0	0	238
10:00	3	189	28	0	3	5	0	4	3	0	0	0	0	235
11:00	3	<b>224</b>	26	0	2	6	0	2	<b>6</b>	0	0	0	0	<b>269</b>
12 PM	10	218	35	0	4	5	0	2	4	0	0	0	0	278
13:00	9	242	46	0	<b>6</b>	<b>8</b>	0	<b>4</b>	<b>5</b>	0	0	0	0	320
14:00	<b>11</b>	277	31	0	5	5	<b>1</b>	0	3	0	0	0	0	333
15:00	10	326	41	0	3	4	0	1	2	0	0	0	<b>1</b>	388
16:00	8	431	<b>59</b>	0	4	1	0	2	2	0	0	0	0	507
17:00	5	<b>452</b>	54	0	0	1	0	0	5	0	0	0	0	<b>517</b>
18:00	11	288	44	0	0	4	0	1	2	0	0	0	0	350
19:00	1	198	24	0	0	0	0	1	1	0	0	0	0	225
20:00	2	147	10	0	0	2	0	1	1	0	0	0	0	163
21:00	3	81	7	0	0	2	0	0	3	0	0	0	0	96
22:00	0	39	6	0	0	0	0	0	0	0	0	0	0	45
23:00	0	29	2	0	0	0	0	0	0	0	0	0	0	31
Day Total	105	3832	519	2	45	63	1	29	58	0	0	0	1	4655
Percent	2.3%	82.3%	11.1%	0.0%	1.0%	1.4%	0.0%	0.6%	1.2%	0.0%	0.0%	0.0%	0.0%	
AM Peak	09:00	11:00	09:00	00:00	09:00	08:00		09:00	11:00					11:00
Vol.	9	224	37	1	7	7		6	6					269
PM Peak	14:00	17:00	16:00		13:00	13:00	14:00	13:00	13:00				15:00	17:00
Vol.	11	452	59		6	8	1	4	5				1	517

**All Traffic Data Services**  
www.alltrafficdata.net

Site Code: 6  
Station ID:  
US-550 S/O US-160

SB

Start Time	Bikes	Cars & Trailers	2 Axle Long	Buses	2 Axle 6 Tire	3 Axle Single	4 Axle Single	<5 Axl Double	5 Axle Double	>6 Axl Double	<6 Axl Multi	6 Axle Multi	>6 Axl Multi	Total
09/28/18	0	18	2	0	1	1	0	0	0	0	0	0	0	22
01:00	1	11	1	0	0	1	0	0	2	0	0	0	0	16
02:00	0	7	2	0	0	0	0	0	0	0	0	0	0	9
03:00	1	5	3	0	0	1	0	0	1	0	0	0	0	11
04:00	0	12	1	0	1	0	0	0	3	0	0	0	0	17
05:00	1	25	7	0	0	1	0	2	<b>5</b>	0	0	0	0	41
06:00	3	86	11	0	4	1	0	2	0	0	0	0	0	107
07:00	<b>13</b>	147	10	0	5	3	0	2	3	0	0	0	0	183
08:00	5	141	35	1	3	2	0	2	4	0	0	0	0	193
09:00	3	171	34	<b>2</b>	6	2	0	2	5	0	0	0	0	225
10:00	9	204	<b>48</b>	0	<b>9</b>	6	0	<b>4</b>	4	0	0	0	0	284
11:00	9	<b>254</b>	39	0	2	<b>9</b>	0	2	5	0	0	0	0	<b>320</b>
12 PM	4	244	39	0	5	5	0	4	<b>5</b>	0	0	0	0	306
13:00	8	283	43	0	1	5	0	1	2	0	0	0	0	343
14:00	5	282	30	0	4	4	0	4	5	0	0	0	0	334
15:00	6	367	55	0	<b>8</b>	<b>9</b>	0	2	2	0	0	0	0	449
16:00	<b>10</b>	381	50	0	3	4	0	<b>5</b>	2	0	0	0	0	455
17:00	7	<b>403</b>	<b>65</b>	0	1	4	0	1	2	0	0	0	0	<b>483</b>
18:00	8	318	42	0	2	3	0	1	1	0	0	0	0	375
19:00	3	232	30	0	1	0	0	0	1	0	0	0	0	267
20:00	3	147	16	0	0	0	0	1	0	0	0	0	0	167
21:00	2	112	5	0	1	0	0	0	1	0	0	0	0	121
22:00	1	87	10	0	0	1	0	0	1	0	0	0	0	100
23:00	0	45	2	0	0	1	0	0	1	0	0	0	0	49
Day Total	102	3982	580	3	57	63	0	35	55	0	0	0	0	4877
Percent	2.1%	81.6%	11.9%	0.1%	1.2%	1.3%	0.0%	0.7%	1.1%	0.0%	0.0%	0.0%	0.0%	
AM Peak	07:00	11:00	10:00	09:00	10:00	11:00		10:00	05:00					11:00
Vol.	13	254	48	2	9	9		4	5					320
PM Peak	16:00	17:00	17:00		15:00	15:00		16:00	12:00					17:00
Vol.	10	403	65		8	9		5	5					483

**All Traffic Data Services**  
www.alltrafficdata.net

Site Code: 6  
Station ID:  
US-550 S/O US-160

SB

Start Time	Bikes	Cars & Trailers	2 Axle Long	Buses	2 Axle 6 Tire	3 Axle Single	4 Axle Single	<5 Axl Double	5 Axle Double	>6 Axl Double	<6 Axl Multi	6 Axle Multi	>6 Axl Multi	Total
09/29/18	1	29	2	0	0	1	0	0	1	0	0	0	0	34
01:00	0	16	0	0	0	0	0	1	0	0	0	0	0	17
02:00	0	17	3	0	0	0	0	0	0	0	0	0	0	20
03:00	1	10	3	0	0	1	0	0	0	0	0	0	0	15
04:00	2	13	2	0	0	2	0	0	3	0	0	0	0	22
05:00	4	27	2	0	1	2	0	0	0	0	0	0	0	36
06:00	2	62	4	0	0	1	0	2	2	0	0	0	0	73
07:00	1	99	9	0	3	1	0	0	0	0	0	0	0	113
08:00	7	152	14	0	2	2	0	1	2	0	0	0	0	180
09:00	6	192	24	0	1	0	0	3	1	0	0	0	0	227
10:00	12	225	42	1	5	0	0	2	3	0	0	0	0	290
11:00	10	261	31	0	1	1	0	2	3	0	0	0	0	309
12 PM	8	270	21	0	2	1	0	1	5	0	0	0	2	310
13:00	6	255	27	0	1	2	0	2	1	0	1	0	0	295
14:00	7	302	32	0	1	0	0	0	3	0	0	0	0	345
15:00	16	292	30	0	1	0	0	2	3	0	0	0	0	344
16:00	18	362	37	0	1	0	0	2	2	0	0	0	0	422
17:00	13	316	33	0	0	0	0	1	2	0	0	0	0	365
18:00	15	321	35	0	0	2	0	0	1	0	0	0	0	374
19:00	11	223	21	0	0	1	0	2	0	0	0	0	0	258
20:00	4	198	24	0	0	0	0	0	0	0	0	0	0	226
21:00	0	108	7	0	0	0	0	0	1	0	0	0	0	116
22:00	2	68	0	0	0	1	0	1	1	0	0	0	0	73
23:00	1	47	4	0	0	0	0	1	0	0	0	0	0	53
Day Total	147	3865	407	1	19	18	0	23	34	0	1	0	2	4517
Percent	3.3%	85.6%	9.0%	0.0%	0.4%	0.4%	0.0%	0.5%	0.8%	0.0%	0.0%	0.0%	0.0%	
AM Peak	10:00	11:00	10:00	10:00	10:00	04:00		09:00	04:00					11:00
Vol.	12	261	42	1	5	2		3	3					309
PM Peak	16:00	16:00	16:00		12:00	13:00		13:00	12:00		13:00		12:00	16:00
Vol.	18	362	37		2	2		2	5		1		2	422



**All Traffic Data Services**  
www.alltrafficdata.net

Site Code: 6  
Station ID:  
US-550 S/O US-160

SB

Start Time	Bikes	Cars & Trailers	2 Axle Long	Buses	2 Axle 6 Tire	3 Axle Single	4 Axle Single	<5 Axl Double	5 Axle Double	>6 Axl Double	<6 Axl Multi	6 Axle Multi	>6 Axl Multi	Total
09/30/18	0	27	2	0	0	0	0	0	0	0	0	0	0	29
01:00	0	21	4	0	0	0	0	0	0	0	0	0	0	25
02:00	1	28	1	0	0	0	0	0	0	0	0	0	0	30
03:00	1	10	2	0	0	1	0	0	0	0	0	0	0	14
04:00	0	12	1	0	0	0	0	0	2	0	0	0	0	15
05:00	0	17	3	0	0	0	0	0	0	0	0	0	0	20
06:00	3	27	2	1	0	1	0	0	1	0	0	0	0	35
07:00	0	60	6	0	0	1	0	0	1	0	0	0	0	68
08:00	3	122	15	0	2	2	0	1	2	0	0	0	0	147
09:00	5	157	15	0	0	0	0	3	6	0	0	0	0	186
10:00	7	188	16	1	1	2	0	5	3	0	0	0	0	223
11:00	2	<b>283</b>	<b>26</b>	0	1	1	0	0	0	0	0	0	0	<b>313</b>
12 PM	10	251	31	1	0	1	0	1	1	0	0	0	0	296
13:00	10	268	26	0	1	2	0	1	5	0	0	0	0	313
14:00	10	<b>315</b>	32	0	0	1	0	3	2	0	0	0	0	363
15:00	<b>19</b>	307	<b>37</b>	0	0	1	1	1	1	0	0	0	0	<b>367</b>
16:00	19	288	36	0	0	1	0	2	0	0	0	0	0	346
17:00	10	278	28	0	1	2	0	0	1	0	0	0	0	320
18:00	6	291	26	0	2	1	0	0	2	0	0	0	0	328
19:00	5	197	25	0	1	0	0	0	1	0	0	0	0	229
20:00	2	105	18	0	0	1	0	2	1	0	0	0	0	129
21:00	0	69	8	0	0	0	0	1	4	0	0	0	0	82
22:00	0	39	2	0	0	1	0	0	2	0	0	0	0	44
23:00	0	19	0	0	0	1	0	0	0	0	0	0	0	20
Day Total	113	3379	362	3	9	20	1	20	35	0	0	0	0	3942
Percent	2.9%	85.7%	9.2%	0.1%	0.2%	0.5%	0.0%	0.5%	0.9%	0.0%	0.0%	0.0%	0.0%	
AM Peak	10:00	11:00	11:00	06:00	08:00	08:00		10:00	09:00					11:00
Vol.	7	283	26	1	2	2		5	6					313
PM Peak	15:00	14:00	15:00	12:00	18:00	13:00	15:00	14:00	13:00					15:00
Vol.	19	315	37	1	2	2	1	3	5					367

**All Traffic Data Services**  
www.alltrafficdata.net

Site Code: 6  
Station ID:  
US-550 S/O US-160

SB

Start Time	Bikes	Cars & Trailers	2 Axle Long	Buses	2 Axle 6 Tire	3 Axle Single	4 Axle Single	<5 Axl Double	5 Axle Double	>6 Axl Double	<6 Axl Multi	6 Axle Multi	>6 Axl Multi	Total
10/01/18	0	8	0	0	0	0	0	0	1	0	0	0	0	9
01:00	0	6	1	0	0	0	0	0	1	0	0	0	0	8
02:00	2	6	1	0	0	0	0	0	0	0	0	0	0	9
03:00	2	8	2	0	0	0	0	0	0	0	0	0	0	12
04:00	0	13	3	0	1	0	0	0	3	0	0	0	0	20
05:00	1	30	6	1	1	1	0	0	3	0	0	0	0	43
06:00	1	109	9	0	2	0	0	1	1	0	0	0	0	123
07:00	2	133	10	0	1	1	0	1	1	0	0	0	0	149
08:00	2	157	15	0	4	3	0	5	3	0	0	0	0	189
09:00	<b>10</b>	190	33	0	4	5	0	0	4	0	0	0	0	246
10:00	7	<b>220</b>	31	<b>2</b>	<b>5</b>	<b>6</b>	0	<b>7</b>	4	0	<b>1</b>	0	0	<b>283</b>
11:00	2	214	<b>34</b>	0	5	4	0	3	<b>5</b>	0	0	0	0	267
12 PM	3	232	37	0	5	5	0	0	<b>12</b>	0	0	0	0	294
13:00	8	257	29	1	<b>6</b>	4	0	1	3	0	0	0	0	309
14:00	2	273	40	0	3	4	0	1	6	0	0	0	0	329
15:00	2	354	45	<b>2</b>	6	4	0	<b>4</b>	6	0	0	0	0	423
16:00	7	406	50	0	3	3	0	3	4	0	0	0	0	476
17:00	<b>9</b>	<b>450</b>	<b>55</b>	0	3	2	0	2	4	0	0	0	0	<b>525</b>
18:00	2	256	38	0	0	<b>6</b>	0	0	2	0	0	0	0	304
19:00	0	149	22	0	1	1	0	0	1	0	0	0	0	174
20:00	1	98	16	0	0	1	0	0	3	0	0	0	0	119
21:00	3	82	6	0	0	2	0	0	1	0	0	0	0	94
22:00	2	32	2	0	0	2	0	0	0	0	0	0	0	38
23:00	0	22	2	0	0	0	0	0	0	0	0	0	0	24
Day Total	68	3705	487	6	50	54	0	28	68	0	1	0	0	4467
Percent	1.5%	82.9%	10.9%	0.1%	1.1%	1.2%	0.0%	0.6%	1.5%	0.0%	0.0%	0.0%	0.0%	
AM Peak	09:00	10:00	11:00	10:00	10:00	10:00		10:00	11:00		10:00			10:00
Vol.	10	220	34	2	5	6		7	5		1			283
PM Peak	17:00	17:00	17:00	15:00	13:00	18:00		15:00	12:00					17:00
Vol.	9	450	55	2	6	6		4	12					525

**All Traffic Data Services**  
www.alltrafficdata.net

Site Code: 6  
Station ID:  
US-550 S/O US-160

SB

Start Time	Bikes	Cars & Trailers	2 Axle Long	Buses	2 Axle 6 Tire	3 Axle Single	4 Axle Single	<5 Axl Double	5 Axle Double	>6 Axl Double	<6 Axl Multi	6 Axle Multi	>6 Axl Multi	Total
10/02/18	0	11	0	0	0	0	0	0	1	0	0	0	0	12
01:00	0	7	1	0	2	0	0	0	0	0	0	0	0	10
02:00	1	6	3	0	0	1	0	0	1	0	0	0	0	12
03:00	0	5	1	0	0	0	0	0	2	0	0	0	0	8
04:00	1	9	2	0	1	1	0	0	4	0	0	0	0	18
05:00	1	21	8	0	1	1	0	2	5	0	0	0	0	39
06:00	3	96	13	0	2	1	0	0	2	0	0	0	0	117
07:00	5	132	15	0	4	5	0	1	1	0	0	0	0	163
08:00	6	167	37	<b>3</b>	4	<b>6</b>	0	2	3	0	0	0	0	228
09:00	4	153	43	0	4	5	0	2	<b>6</b>	0	0	0	0	217
10:00	3	185	45	0	<b>11</b>	5	0	<b>3</b>	3	0	0	0	0	255
11:00	<b>8</b>	<b>199</b>	<b>51</b>	0	2	3	<b>1</b>	0	6	0	0	0	0	<b>270</b>
12 PM	6	240	43	0	4	<b>6</b>	0	2	<b>5</b>	0	0	0	0	306
13:00	4	235	36	0	6	5	<b>1</b>	2	4	0	0	0	0	293
14:00	3	236	56	0	2	3	0	<b>4</b>	2	0	0	0	0	306
15:00	3	297	53	0	<b>7</b>	1	0	2	4	0	0	0	0	367
16:00	3	367	52	0	4	2	0	1	5	0	0	0	0	434
17:00	<b>8</b>	<b>487</b>	<b>68</b>	0	3	3	0	4	4	0	0	0	0	<b>577</b>
18:00	6	272	25	<b>1</b>	0	0	0	0	4	0	0	0	0	308
19:00	3	163	23	0	0	2	0	1	4	0	0	0	0	196
20:00	1	114	13	0	1	1	0	1	2	0	0	0	0	133
21:00	0	78	7	0	0	1	0	1	3	0	0	0	0	90
22:00	0	46	3	0	1	0	0	0	2	0	0	0	0	52
23:00	0	32	1	0	0	0	0	0	0	0	0	0	0	33
Day Total	69	3558	599	4	59	52	2	28	73	0	0	0	0	4444
Percent	1.6%	80.1%	13.5%	0.1%	1.3%	1.2%	0.0%	0.6%	1.6%	0.0%	0.0%	0.0%	0.0%	
AM Peak	11:00	11:00	11:00	08:00	10:00	08:00	11:00	10:00	09:00					11:00
Vol.	8	199	51	3	11	6	1	3	6					270
PM Peak	17:00	17:00	17:00	18:00	15:00	12:00	13:00	14:00	12:00					17:00
Vol.	8	487	68	1	7	6	1	4	5					577

**All Traffic Data Services**  
www.alltrafficdata.net

Site Code: 6  
Station ID:  
US-550 S/O US-160

SB

Start Time	Bikes	Cars & Trailers	2 Axle Long	Buses	2 Axle 6 Tire	3 Axle Single	4 Axle Single	<5 Axl Double	5 Axle Double	>6 Axl Double	<6 Axl Multi	6 Axle Multi	>6 Axl Multi	Total
10/03/18	1	7	2	0	0	1	0	0	0	0	0	0	0	11
01:00	0	10	2	0	0	1	0	0	1	0	0	0	0	14
02:00	0	8	2	0	0	0	0	1	1	0	0	0	0	12
03:00	1	9	2	0	0	1	0	0	2	0	0	0	0	15
04:00	0	8	0	0	1	0	0	0	1	0	0	0	0	10
05:00	1	24	6	0	0	0	0	2	1	0	0	0	0	34
06:00	2	91	14	0	3	2	0	2	3	0	0	0	0	117
07:00	4	128	17	0	0	3	0	1	5	0	0	0	0	158
08:00	2	131	33	2	8	2	0	2	7	0	0	0	0	187
09:00	5	148	37	1	7	7	0	6	7	0	0	0	0	218
10:00	3	176	43	1	11	6	1	3	5	0	0	0	0	249
11:00	4	225	38	0	3	4	1	1	4	0	0	0	0	280
12 PM	8	234	35	0	2	3	1	0	8	0	0	0	0	291
13:00	9	219	25	0	3	11	1	0	3	0	0	0	0	271
14:00	4	278	26	0	2	4	0	1	5	0	0	0	0	320
15:00	10	344	45	0	6	1	0	5	9	0	0	0	0	420
16:00	7	394	44	0	7	4	0	4	5	0	0	0	0	465
17:00	5	448	58	0	0	4	0	2	1	0	0	0	0	518
18:00	8	290	33	0	3	3	0	1	3	0	0	0	0	341
19:00	0	194	23	0	1	2	0	0	2	0	0	0	0	222
20:00	4	148	16	0	1	4	0	1	5	0	0	0	0	179
21:00	1	79	6	0	0	2	0	0	2	0	0	0	0	90
22:00	0	56	3	0	0	0	0	0	0	0	0	0	0	59
23:00	0	31	3	0	0	0	0	0	2	0	0	0	0	36
Day Total	79	3680	513	4	58	65	4	32	82	0	0	0	0	4517
Percent	1.7%	81.5%	11.4%	0.1%	1.3%	1.4%	0.1%	0.7%	1.8%	0.0%	0.0%	0.0%	0.0%	
AM Peak	09:00	11:00	10:00	08:00	10:00	09:00	10:00	09:00	08:00					11:00
Vol.	5	225	43	2	11	7	1	6	7					280
PM Peak	15:00	17:00	17:00		16:00	13:00	12:00	15:00	15:00					17:00
Vol.	10	448	58		7	11	1	5	9					518
Grand Total	683	26001	3467	23	297	335	8	195	405	0	2	0	3	31419
Percent	2.2%	82.8%	11.0%	0.1%	0.9%	1.1%	0.0%	0.6%	1.3%	0.0%	0.0%	0.0%	0.0%	

**All Traffic Data Services**  
www.alltrafficdata.net

Site Code: 7  
Station ID:  
CR 220 E/O US-550

EB

Start Time	Bikes	Cars & Trailers	2 Axle Long	Buses	2 Axle 6 Tire	3 Axle Single	4 Axle Single	<5 Axl Double	5 Axle Double	>6 Axl Double	<6 Axl Multi	6 Axle Multi	>6 Axl Multi	Total
09/27/18	0	3	0	0	0	0	0	0	0	0	0	0	0	3
01:00	0	0	0	0	0	0	0	0	0	0	0	0	0	0
02:00	0	0	0	0	0	0	0	0	0	0	0	0	0	0
03:00	0	1	0	0	0	0	0	0	0	0	0	0	0	1
04:00	0	1	0	0	0	0	0	0	0	0	0	0	0	1
05:00	1	3	0	0	0	0	0	0	0	0	0	0	0	4
06:00	<b>2</b>	8	0	0	0	0	0	0	0	0	0	0	0	10
07:00	0	17	<b>2</b>	0	0	0	0	0	0	0	0	0	0	19
08:00	1	<b>34</b>	1	0	0	<b>2</b>	0	0	0	0	0	0	0	<b>38</b>
09:00	1	24	2	0	0	1	0	0	0	0	0	0	0	28
10:00	1	27	2	0	0	0	0	0	0	0	0	0	0	30
11:00	0	30	2	0	0	0	0	0	0	0	0	0	0	32
12 PM	1	44	0	0	0	0	0	0	0	0	0	0	0	45
13:00	1	47	2	0	0	0	0	0	0	0	0	0	0	50
14:00	4	40	0	0	<b>1</b>	0	0	0	0	0	0	0	0	45
15:00	<b>5</b>	56	2	0	1	0	0	0	0	0	0	0	0	64
16:00	0	<b>82</b>	<b>3</b>	0	1	0	0	<b>1</b>	0	0	0	0	0	<b>87</b>
17:00	1	80	2	0	0	0	0	0	0	0	0	0	0	83
18:00	2	52	1	0	0	0	0	0	0	0	0	0	0	55
19:00	3	38	1	0	0	0	0	0	0	0	0	0	0	42
20:00	2	28	2	0	0	0	0	0	0	0	0	0	0	32
21:00	1	18	0	0	0	0	0	0	0	0	0	0	0	19
22:00	0	4	0	0	0	0	0	0	0	0	0	0	0	4
23:00	0	2	0	0	0	0	0	0	0	0	0	0	0	2
Day Total	26	639	22	0	3	3	0	1	0	0	0	0	0	694
Percent	3.7%	92.1%	3.2%	0.0%	0.4%	0.4%	0.0%	0.1%	0.0%	0.0%	0.0%	0.0%	0.0%	
AM Peak	06:00	08:00	07:00			08:00								08:00
Vol.	2	34	2			2								38
PM Peak	15:00	16:00	16:00		14:00			16:00						16:00
Vol.	5	82	3		1			1						87

**All Traffic Data Services**  
www.alltrafficdata.net

Site Code: 7  
Station ID:  
CR 220 E/O US-550

EB

Start Time	Bikes	Cars & Trailers	2 Axle Long	Buses	2 Axle 6 Tire	3 Axle Single	4 Axle Single	<5 Axl Double	5 Axle Double	>6 Axl Double	<6 Axl Multi	6 Axle Multi	>6 Axl Multi	Total
09/28/18	0	4	0	0	0	0	0	0	0	0	0	0	0	4
01:00	0	0	0	0	0	0	0	0	0	0	0	0	0	0
02:00	0	1	0	0	0	0	0	0	0	0	0	0	0	1
03:00	0	1	0	0	0	0	0	0	0	0	0	0	0	1
04:00	0	1	0	0	0	0	0	0	0	0	0	0	0	1
05:00	0	1	0	0	0	0	0	0	0	0	0	0	0	1
06:00	<b>2</b>	1	0	0	0	0	0	0	0	0	0	0	0	3
07:00	0	17	0	0	0	0	0	0	0	0	0	0	0	17
08:00	1	26	<b>1</b>	0	0	0	0	0	0	0	0	0	0	28
09:00	1	16	0	0	0	0	0	0	0	0	0	0	0	17
10:00	1	36	0	0	0	0	0	0	0	0	0	0	0	37
11:00	1	<b>54</b>	1	0	0	0	0	0	0	0	0	0	0	<b>56</b>
12 PM	1	45	<b>3</b>	0	0	0	0	0	0	0	0	0	0	49
13:00	<b>4</b>	53	1	0	<b>1</b>	0	0	0	0	0	0	0	0	59
14:00	3	59	0	0	0	0	0	0	0	0	0	0	0	62
15:00	4	77	3	0	1	0	0	0	0	0	0	0	0	85
16:00	2	73	1	0	1	0	0	0	0	0	0	0	0	77
17:00	2	<b>81</b>	3	0	0	0	0	0	<b>1</b>	0	0	0	0	<b>87</b>
18:00	0	47	1	0	0	0	0	0	0	0	0	0	0	48
19:00	1	42	0	0	0	0	0	0	0	0	0	0	0	43
20:00	2	23	1	0	0	0	0	0	0	0	0	0	0	26
21:00	3	14	0	0	0	0	0	0	0	0	0	0	0	17
22:00	2	16	0	0	0	0	0	0	0	0	0	0	0	18
23:00	1	5	0	0	0	0	0	0	0	0	0	0	0	6
Day Total	31	693	15	0	3	0	0	0	1	0	0	0	0	743
Percent	4.2%	93.3%	2.0%	0.0%	0.4%	0.0%	0.0%	0.0%	0.1%	0.0%	0.0%	0.0%	0.0%	
AM Peak	06:00	11:00	08:00											11:00
Vol.	2	54	1											56
PM Peak	13:00	17:00	12:00		13:00				17:00					17:00
Vol.	4	81	3		1				1					87





























## Appendix B: Analysis Results

	→	↘	↙	←	↖	↗		
Movement	EBT	EBR	WBL	WBT	NBL	NBR		
Lane Configurations	↑↑	↑	↘	↑↑	↘	↗		
Traffic Volume (veh/h)	895	190	28	1555	560	102		
Future Volume (veh/h)	895	190	28	1555	560	102		
Number	6	16	5	2	3	18		
Initial Q (Qb), veh	0	0	0	0	0	0		
Ped-Bike Adj(A_pbT)		1.00	1.00		1.00	1.00		
Parking Bus, Adj	1.00	1.00	1.00	1.00	1.00	1.00		
Adj Sat Flow, veh/h/ln	1863	1863	1863	1863	1863	1863		
Adj Flow Rate, veh/h	1091	0	34	1896	683	124		
Adj No. of Lanes	2	1	1	2	1	1		
Peak Hour Factor	0.82	0.82	0.82	0.82	0.82	0.82		
Percent Heavy Veh, %	2	2	2	2	2	2		
Cap, veh/h	1143	511	42	0	712	673		
Arrive On Green	0.32	0.00	0.02	0.00	0.40	0.40		
Sat Flow, veh/h	3632	1583	1774	34	1774	1583		
Grp Volume(v), veh/h	1091	0	34	67.2	683	124		
Grp Sat Flow(s),veh/h/ln	1770	1583	1774	E	1774	1583		
Q Serve(g_s), s	30.2	0.0	1.9		37.5	2.5		
Cycle Q Clear(g_c), s	30.2	0.0	1.9		37.5	2.5		
Prop In Lane		1.00	1.00		1.00	1.00		
Lane Grp Cap(c), veh/h	1143	511	42		712	673		
V/C Ratio(X)	0.95	0.00	0.80		0.96	0.18		
Avail Cap(c_a), veh/h	1143	511	165		745	703		
HCM Platoon Ratio	1.00	1.00	1.00		1.00	1.00		
Upstream Filter(I)	1.00	0.00	1.00		1.00	1.00		
Uniform Delay (d), s/veh	33.1	0.0	48.6		29.2	17.9		
Incr Delay (d2), s/veh	17.7	0.0	18.6		22.8	0.1		
Initial Q Delay(d3),s/veh	0.0	0.0	0.0		0.0	0.0		
%ile BackOfQ(50%),veh/ln	17.5	0.0	1.2		22.7	1.1		
LnGrp Delay(d),s/veh	50.8	0.0	67.2		52.0	18.0		
LnGrp LOS	D		E		D	B		
Approach Vol, veh/h	1091				807			
Approach Delay, s/veh	50.8				46.7			
Approach LOS	D				D			
<b>Timer</b>	1	2	3	4	5	6	7	8
Assigned Phs					5	6		8
Phs Duration (G+Y+Rc), s					8.1	38.0		45.1
Change Period (Y+Rc), s					5.7	5.7		5.0
Max Green Setting (Gmax), s					9.3	32.3		42.0
Max Q Clear Time (g_c+I1), s					3.9	32.2		39.5
Green Ext Time (p_c), s					0.0	0.1		0.6
<b>Intersection Summary</b>								
HCM 2010 Ctrl Delay			49.4					
HCM 2010 LOS			D					



Intersection						
Int Delay, s/veh	1.6					
Movement	WBL	WBR	NBT	NBR	SBL	SBT
Lane Configurations	↔		↔			↑
Traffic Vol, veh/h	0	79	546	0	28	183
Future Vol, veh/h	0	79	546	0	28	183
Conflicting Peds, #/hr	0	0	0	0	0	0
Sign Control	Stop	Stop	Free	Free	Free	Free
RT Channelized	-	None	-	None	-	None
Storage Length	0	-	-	-	-	-
Veh in Median Storage, #	0	-	0	-	-	0
Grade, %	0	-	0	-	-	0
Peak Hour Factor	88	88	88	88	88	88
Heavy Vehicles, %	2	2	2	2	2	2
Mvmt Flow	0	90	620	0	32	208

Major/Minor	Minor1	Major1	Major2			
Conflicting Flow All	892	620	0	0	620	0
Stage 1	620	-	-	-	-	-
Stage 2	272	-	-	-	-	-
Critical Hdwy	6.42	6.22	-	-	4.12	-
Critical Hdwy Stg 1	5.42	-	-	-	-	-
Critical Hdwy Stg 2	5.42	-	-	-	-	-
Follow-up Hdwy	3.518	3.318	-	-	2.218	-
Pot Cap-1 Maneuver	312	488	-	-	960	-
Stage 1	536	-	-	-	-	-
Stage 2	774	-	-	-	-	-
Platoon blocked, %			-	-		-
Mov Cap-1 Maneuver	300	488	-	-	960	-
Mov Cap-2 Maneuver	300	-	-	-	-	-
Stage 1	536	-	-	-	-	-
Stage 2	745	-	-	-	-	-

Approach	WB	NB	SB
HCM Control Delay, s	14	0	1.2
HCM LOS	B		

Minor Lane/Major Mvmt	NBT	NBRWBLn1	SBL	SBT
Capacity (veh/h)	-	-	488	960
HCM Lane V/C Ratio	-	-	0.184	0.033
HCM Control Delay (s)	-	-	14	8.9
HCM Lane LOS	-	-	B	A
HCM 95th %tile Q(veh)	-	-	0.7	0.1

# MOVEMENT SUMMARY

 Site: 101 [Wilson Gulch Dr & US 160 Ramps AM]

Roundabout

Movement Performance - Vehicles												
Mov ID	OD Mov	Demand Total veh/h	Flows HV %	Deg. Satn v/c	Average Delay sec	Level of Service	95% Back of Queue Vehicles veh	Distance ft	Prop. Queued	Effective Stop Rate per veh	Average Speed mph	
South: Wilson Gulch Dr												
3u	U	1	3.0	0.004	3.7	LOS A	0.0	0.4	0.40	0.21	35.0	
3	L2	1	3.0	0.004	3.7	LOS A	0.0	0.4	0.40	0.21	34.2	
8	T1	1	3.0	0.004	3.7	LOS A	0.0	0.4	0.40	0.21	34.1	
18	R2	1	3.0	0.004	3.7	LOS A	0.0	0.4	0.40	0.21	33.1	
Approach		4	3.0	0.004	3.7	LOS A	0.0	0.4	0.40	0.21	34.1	
East: US 160 WB Ramps												
1u	U	1	3.0	0.006	3.7	LOS A	0.0	0.6	0.40	0.22	35.3	
1	L2	1	3.0	0.006	3.7	LOS A	0.0	0.6	0.40	0.22	34.5	
6	T1	1	3.0	0.006	3.7	LOS A	0.0	0.6	0.40	0.22	34.4	
16	R2	2	3.0	0.006	3.7	LOS A	0.0	0.6	0.40	0.22	33.4	
Approach		5	3.0	0.006	3.7	LOS A	0.0	0.6	0.40	0.22	34.2	
North: Wilson Gulch Dr												
7u	U	66	3.0	0.071	3.3	LOS A	0.3	7.9	0.07	0.01	34.1	
7	L2	1	3.0	0.071	3.3	LOS A	0.3	7.9	0.07	0.01	33.3	
4	T1	25	3.0	0.071	3.3	LOS A	0.3	7.9	0.07	0.01	33.3	
14	R2	1	3.0	0.071	3.3	LOS A	0.3	7.9	0.07	0.01	32.4	
Approach		93	3.0	0.071	3.3	LOS A	0.3	7.9	0.07	0.01	33.8	
West: US 160 EB Off Ramp												
5u	U	7	3.0	0.183	4.4	LOS A	0.8	20.7	0.24	0.12	33.5	
5	L2	223	3.0	0.183	4.4	LOS A	0.8	20.7	0.24	0.12	32.8	
2	T1	1	3.0	0.183	4.4	LOS A	0.8	20.7	0.24	0.12	32.7	
12	R2	11	3.0	0.008	2.7	LOS A	0.0	0.8	0.10	0.02	35.3	
Approach		241	3.0	0.183	4.3	LOS A	0.8	20.7	0.23	0.11	32.9	
All Vehicles		345	3.0	0.183	4.0	LOS A	0.8	20.7	0.19	0.09	33.2	

Site Level of Service (LOS) Method: Delay & v/c (HCM 6). Site LOS Method is specified in the Parameter Settings dialog (Site tab).

Roundabout LOS Method: Same as Sign Control.

Vehicle movement LOS values are based on average delay and v/c ratio (degree of saturation) per movement.

LOS F will result if v/c > 1 irrespective of movement delay value (does not apply for approaches and intersection).

Intersection and Approach LOS values are based on average delay for all movements (v/c not used as specified in HCM 6).

Roundabout Capacity Model: US HCM 6.





























HCM Delay Formula option is used. Control Delay does not include Geometric Delay since Exclude Geometric Delay option applies.

























Gap-Acceptance Capacity: Traditional M1.

HV (%) values are calculated for All Movement Classes of All Heavy Vehicle Model Designation.

HCM 2010 Signalized Intersection Summary  
4: Three Springs Road & US 160

Existing Conditions Summer AM  
01/08/2019

												
Movement	EBL	EBT	EBR	WBL	WBT	WBR	NBL	NBT	NBR	SBL	SBT	SBR
Lane Configurations	 	 			 					 		
Traffic Volume (veh/h)	420	499	2	28	1520	268	30	9	12	60	3	151
Future Volume (veh/h)	420	499	2	28	1520	268	30	9	12	60	3	151
Number	1	6	16	5	2	12	3	8	18	7	4	14
Initial Q (Qb), veh	0	0	0	0	0	0	0	0	0	0	0	0
Ped-Bike Adj(A_pbT)	1.00		1.00	1.00		1.00	1.00		1.00	1.00		1.00
Parking Bus, Adj	1.00	1.00	1.00	1.00	1.00	1.00	1.00	1.00	1.00	1.00	1.00	1.00
Adj Sat Flow, veh/h/ln	1740	1707	1740	1740	1707	1740	1740	1740	1740	1740	1740	1740
Adj Flow Rate, veh/h	488	580	0	36	1974	0	43	13	0	78	4	0
Adj No. of Lanes	2	2	1	1	2	1	1	1	1	2	1	1
Peak Hour Factor	0.86	0.86	0.86	0.77	0.77	0.77	0.69	0.69	0.69	0.77	0.77	0.77
Percent Heavy Veh, %	2	4	2	2	4	2	2	2	2	2	2	2
Cap, veh/h	563	2324	1031	52	1858	818	181	74	48	357	82	55
Arrive On Green	0.17	0.72	0.00	0.03	0.57	0.00	0.03	0.04	0.00	0.04	0.05	0.00
Sat Flow, veh/h	3215	3243	1479	1657	3243	1479	1657	1740	1479	3215	1740	1479
Grp Volume(v), veh/h	488	580	0	36	1974	0	43	13	0	78	4	0
Grp Sat Flow(s),veh/h/ln	1608	1621	1479	1657	1621	1479	1657	1740	1479	1608	1740	1479
Q Serve(g_s), s	14.8	6.2	0.0	2.2	57.3	0.0	0.0	0.7	0.0	0.0	0.2	0.0
Cycle Q Clear(g_c), s	14.8	6.2	0.0	2.2	57.3	0.0	0.0	0.7	0.0	0.0	0.2	0.0
Prop In Lane	1.00		1.00	1.00		1.00	1.00		1.00	1.00		1.00
Lane Grp Cap(c), veh/h	563	2324	1031	52	1858	818	181	74	48	357	82	55
V/C Ratio(X)	0.87	0.25	0.00	0.69	1.06	0.00	0.24	0.18	0.00	0.22	0.05	0.00
Avail Cap(c_a), veh/h	563	2324	1031	96	1858	818	241	118	86	458	118	86
HCM Platoon Ratio	1.00	1.00	1.00	1.00	1.00	1.00	1.00	1.00	1.00	1.00	1.00	1.00
Upstream Filter(I)	1.00	1.00	0.00	1.00	1.00	0.00	1.00	1.00	0.00	1.00	1.00	0.00
Uniform Delay (d), s/veh	40.1	4.9	0.0	48.0	21.4	0.0	44.4	46.2	0.0	44.4	45.5	0.0
Incr Delay (d2), s/veh	13.2	0.3	0.0	9.8	39.7	0.0	0.4	0.7	0.0	0.2	0.1	0.0
Initial Q Delay(d3),s/veh	0.0	0.0	0.0	0.0	0.0	0.0	0.0	0.0	0.0	0.0	0.0	0.0
%ile BackOfQ(50%),veh/ln	7.6	2.8	0.0	1.1	35.5	0.0	1.2	0.4	0.0	1.0	0.1	0.0
LnGrp Delay(d),s/veh	53.3	5.1	0.0	57.7	61.1	0.0	44.8	46.9	0.0	44.5	45.6	0.0
LnGrp LOS	D	A		E	F		D	D		D	D	
Approach Vol, veh/h		1068			2010			56			82	
Approach Delay, s/veh		27.2			61.0			45.3			44.6	
Approach LOS		C			E			D			D	
Timer	1	2	3	4	5	6	7	8				
Assigned Phs	1	2	3	4	5	6	7	8				
Phs Duration (G+Y+Rc), s	22.7	61.0	7.4	8.9	8.3	75.4	7.9	8.4				
Change Period (Y+Rc), s	5.7	5.7	* 5.2	* 5.2	5.7	5.7	* 5.2	* 5.2				
Max Green Setting (Gmax), s	11.3	55.3	* 5.8	* 5.8	5.3	61.3	* 5.8	* 5.8				
Max Q Clear Time (g_c+1), s	16.8	59.3	2.0	2.2	4.2	8.2	2.0	2.7				
Green Ext Time (p_c), s	0.0	0.0	0.1	0.0	0.0	4.2	0.1	0.0				
<b>Intersection Summary</b>												
HCM 2010 Ctrl Delay			49.1									
HCM 2010 LOS			D									
<b>Notes</b>												

												
Movement	EBL	EBT	EBR	WBL	WBT	WBR	NBL	NBT	NBR	SBL	SBT	SBR
Lane Configurations												
Traffic Volume (veh/h)	39	251	251	83	997	18	570	41	39	21	60	217
Future Volume (veh/h)	39	251	251	83	997	18	570	41	39	21	60	217
Number	1	6	16	5	2	12	3	8	18	7	4	14
Initial Q (Qb), veh	0	0	0	0	0	0	0	0	0	0	0	0
Ped-Bike Adj(A_pbT)	1.00		1.00	1.00		1.00	1.00		1.00	1.00		1.00
Parking Bus, Adj	1.00	1.00	1.00	1.00	1.00	1.00	1.00	1.00	1.00	1.00	1.00	1.00
Adj Sat Flow, veh/h/ln	1740	1690	1740	1740	1690	1740	1740	1740	1740	1740	1740	1740
Adj Flow Rate, veh/h	41	264	0	109	1312	0	809	0	0	27	76	0
Adj No. of Lanes	1	2	1	1	2	1	2	0	1	1	1	1
Peak Hour Factor	0.95	0.95	0.95	0.76	0.76	0.76	0.74	0.74	0.74	0.79	0.79	0.79
Percent Heavy Veh, %	2	5	2	2	5	2	2	2	2	2	2	2
Cap, veh/h	58	1538	708	629	1606	740	729	0	311	116	121	88
Arrive On Green	0.04	0.48	0.00	0.06	0.50	0.00	0.22	0.00	0.00	0.07	0.07	0.00
Sat Flow, veh/h	1657	3212	1479	1657	3212	1479	3315	0	1479	1657	1740	1479
Grp Volume(v), veh/h	41	264	0	109	1312	0	809	0	0	27	76	0
Grp Sat Flow(s),veh/h/ln	1657	1606	1479	1657	1606	1479	1657	0	1479	1657	1740	1479
Q Serve(g_s), s	2.4	4.7	0.0	3.4	34.5	0.0	22.0	0.0	0.0	1.5	4.2	0.0
Cycle Q Clear(g_c), s	2.4	4.7	0.0	3.4	34.5	0.0	22.0	0.0	0.0	1.5	4.2	0.0
Prop In Lane	1.00		1.00	1.00		1.00	1.00		1.00	1.00		1.00
Lane Grp Cap(c), veh/h	58	1538	708	629	1606	740	729	0	311	116	121	88
V/C Ratio(X)	0.70	0.17	0.00	0.17	0.82	0.00	1.11	0.00	0.00	0.23	0.63	0.00
Avail Cap(c_a), veh/h	108	1538	708	643	1606	740	729	0	311	232	244	192
HCM Platoon Ratio	1.00	1.00	1.00	1.00	1.00	1.00	1.00	1.00	1.00	1.00	1.00	1.00
Upstream Filter(I)	1.00	1.00	0.00	1.00	1.00	0.00	1.00	0.00	0.00	1.00	1.00	0.00
Uniform Delay (d), s/veh	47.7	14.8	0.0	12.4	21.1	0.0	39.0	0.0	0.0	44.0	45.2	0.0
Incr Delay (d2), s/veh	9.0	0.2	0.0	0.1	4.7	0.0	67.5	0.0	0.0	0.6	3.2	0.0
Initial Q Delay(d3),s/veh	0.0	0.0	0.0	0.0	0.0	0.0	0.0	0.0	0.0	0.0	0.0	0.0
%ile BackOfQ(50%),veh/ln	1.3	2.1	0.0	1.5	16.4	0.0	16.9	0.0	0.0	0.7	2.2	0.0
LnGrp Delay(d),s/veh	56.7	15.0	0.0	12.6	25.9	0.0	106.5	0.0	0.0	44.6	48.5	0.0
LnGrp LOS	E	B		B	C		F			D	D	
Approach Vol, veh/h		305			1421			809			103	
Approach Delay, s/veh		20.6			24.8			106.5			47.5	
Approach LOS		C			C			F			D	
Timer	1	2	3	4	5	6	7	8				
Assigned Phs	1	2		4	5	6		8				
Phs Duration (G+Y+Rc), s	9.0	54.0		11.0	11.1	51.9		26.0				
Change Period (Y+Rc), s	6.0	6.0		5.0	6.0	6.0		5.0				
Max Green Setting (Gmax), s	6.0	38.0		13.0	6.0	38.0		21.0				
Max Q Clear Time (g_c+1), s	4.4	36.5		6.2	5.4	6.7		24.0				
Green Ext Time (p_c), s	0.0	1.4		0.1	0.0	27.6		0.0				
<b>Intersection Summary</b>												
HCM 2010 Ctrl Delay			50.3									
HCM 2010 LOS			D									
<b>Notes</b>												

**Intersection**

Int Delay, s/veh 2.2

Movement	EBL	EBT	EBR	WBL	WBT	WBR	NBL	NBT	NBR	SBL	SBT	SBR
Lane Configurations		↑	↗		↕		↘	↑	↗	↘	↑	↗
Traffic Vol, veh/h	43	5	12	3	5	68	20	451	2	20	276	23
Future Vol, veh/h	43	5	12	3	5	68	20	451	2	20	276	23
Conflicting Peds, #/hr	0	0	0	0	0	0	0	0	0	0	0	0
Sign Control	Stop	Stop	Stop	Stop	Stop	Stop	Free	Free	Free	Free	Free	Free
RT Channelized	-	-	Stop	-	-	None	-	-	None	-	-	None
Storage Length	-	-	170	-	-	-	140	-	280	540	-	430
Veh in Median Storage, #	-	0	-	-	0	-	-	0	-	-	0	-
Grade, %	-	0	-	-	0	-	-	0	-	-	0	-
Peak Hour Factor	94	94	94	94	94	94	94	94	94	94	94	94
Heavy Vehicles, %	2	2	2	2	2	2	2	2	2	2	2	2
Mvmt Flow	46	5	13	3	5	72	21	480	2	21	294	24

Major/Minor	Minor2		Minor1		Major1		Major2					
Conflicting Flow All	897	858	294	861	858	480	294	0	0	480	0	0
Stage 1	336	336	-	522	522	-	-	-	-	-	-	-
Stage 2	561	522	-	339	336	-	-	-	-	-	-	-
Critical Hdwy	7.12	6.52	6.22	7.12	6.52	6.22	4.12	-	-	4.12	-	-
Critical Hdwy Stg 1	6.12	5.52	-	6.12	5.52	-	-	-	-	-	-	-
Critical Hdwy Stg 2	6.12	5.52	-	6.12	5.52	-	-	-	-	-	-	-
Follow-up Hdwy	3.518	4.018	3.318	3.518	4.018	3.318	2.218	-	-	2.218	-	-
Pot Cap-1 Maneuver	261	294	745	276	294	586	1268	-	-	1082	-	-
Stage 1	678	642	-	538	531	-	-	-	-	-	-	-
Stage 2	512	531	-	676	642	-	-	-	-	-	-	-
Platoon blocked, %								-	-	-	-	-
Mov Cap-1 Maneuver	219	284	745	260	284	586	1268	-	-	1082	-	-
Mov Cap-2 Maneuver	219	284	-	260	284	-	-	-	-	-	-	-
Stage 1	667	630	-	529	522	-	-	-	-	-	-	-
Stage 2	437	522	-	646	630	-	-	-	-	-	-	-

Approach	EB	WB	NB	SB
HCM Control Delay, s	12.3	13.1	0.3	0.5
HCM LOS	B	B		

Minor Lane/Major Mvmt	NBL	NBT	NBR	EBLn1	EBLn2	WBLn1	SBL	SBT	SBR
Capacity (veh/h)	1268	-	-	284	745	523	1082	-	-
HCM Lane V/C Ratio	0.017	-	-	0.019	0.017	0.155	0.02	-	-
HCM Control Delay (s)	7.9	-	-	17.9	9.9	13.1	8.4	-	-
HCM Lane LOS	A	-	-	C	A	B	A	-	-
HCM 95th %tile Q(veh)	0.1	-	-	0.1	0.1	0.5	0.1	-	-



Movement	EBT	EBR	WBL	WBT	NBL	NBR		
Lane Configurations	↑↑	↑	↑	↑↑	↑	↑		
Traffic Volume (veh/h)	1457	503	85	1203	242	62		
Future Volume (veh/h)	1457	503	85	1203	242	62		
Number	6	16	5	2	3	18		
Initial Q (Qb), veh	0	0	0	0	0	0		
Ped-Bike Adj(A_pbT)		1.00	1.00		1.00	1.00		
Parking Bus, Adj	1.00	1.00	1.00	1.00	1.00	1.00		
Adj Sat Flow, veh/h/ln	1863	1863	1863	1863	1863	1863		
Adj Flow Rate, veh/h	1777	0	104	1467	295	0		
Adj No. of Lanes	2	1	1	2	1	1		
Peak Hour Factor	0.82	0.82	0.82	0.82	0.82	0.82		
Percent Heavy Veh, %	2	2	2	2	2	2		
Cap, veh/h	1886	844	131	0	328	409		
Arrive On Green	0.53	0.00	0.07	0.00	0.18	0.00		
Sat Flow, veh/h	3632	1583	1774	104	1774	1583		
Grp Volume(v), veh/h	1777	0	104	55.9	295	0		
Grp Sat Flow(s),veh/h/ln	1770	1583	1774	E	1774	1583		
Q Serve(g_s), s	47.1	0.0	5.8		16.3	0.0		
Cycle Q Clear(g_c), s	47.1	0.0	5.8		16.3	0.0		
Prop In Lane		1.00	1.00		1.00	1.00		
Lane Grp Cap(c), veh/h	1886	844	131		328	409		
V/C Ratio(X)	0.94	0.00	0.80		0.90	0.00		
Avail Cap(c_a), veh/h	1886	844	190		385	460		
HCM Platoon Ratio	1.00	1.00	1.00		1.00	1.00		
Upstream Filter(I)	1.00	0.00	1.00		1.00	0.00		
Uniform Delay (d), s/veh	21.9	0.0	45.6		39.9	0.0		
Incr Delay (d2), s/veh	10.9	0.0	10.3		20.3	0.0		
Initial Q Delay(d3),s/veh	0.0	0.0	0.0		0.0	0.0		
%ile BackOfQ(50%),veh/ln	25.6	0.0	3.2		9.8	0.0		
LnGrp Delay(d),s/veh	32.8	0.0	55.9		60.2	0.0		
LnGrp LOS	C		E		E			
Approach Vol, veh/h	1777				295			
Approach Delay, s/veh	32.8				60.2			
Approach LOS	C				E			
Timer	1	2	3	4	5	6	7	8
Assigned Phs					5	6		8
Phs Duration (G+Y+Rc), s					11.7	59.0		22.8
Change Period (Y+Rc), s					4.3	* 5.7		4.3
Max Green Setting (Gmax), s					10.7	* 53		21.7
Max Q Clear Time (g_c+I1), s					7.8	49.1		18.3
Green Ext Time (p_c), s					0.0	3.7		0.2
<b>Intersection Summary</b>								
HCM 2010 Ctrl Delay			37.6					
HCM 2010 LOS			D					
<b>Notes</b>								

Intersection						
Int Delay, s/veh	1.4					
Movement	WBL	WBR	NBT	NBR	SBL	SBT
Lane Configurations	↔		↔			↑
Traffic Vol, veh/h	0	43	255	0	99	503
Future Vol, veh/h	0	43	255	0	99	503
Conflicting Peds, #/hr	0	0	0	0	0	0
Sign Control	Stop	Stop	Free	Free	Free	Free
RT Channelized	-	None	-	None	-	None
Storage Length	0	-	-	-	-	-
Veh in Median Storage, #	0	-	0	-	-	0
Grade, %	0	-	0	-	-	0
Peak Hour Factor	88	88	88	88	88	88
Heavy Vehicles, %	2	2	2	2	2	2
Mvmt Flow	0	49	290	0	113	572

Major/Minor	Minor1	Major1	Major2		
Conflicting Flow All	1087	290	0	0	290
Stage 1	290	-	-	-	-
Stage 2	797	-	-	-	-
Critical Hdwy	6.42	6.22	-	-	4.12
Critical Hdwy Stg 1	5.42	-	-	-	-
Critical Hdwy Stg 2	5.42	-	-	-	-
Follow-up Hdwy	3.518	3.318	-	-	2.218
Pot Cap-1 Maneuver	239	749	-	-	1272
Stage 1	759	-	-	-	-
Stage 2	444	-	-	-	-
Platoon blocked, %			-	-	-
Mov Cap-1 Maneuver	208	749	-	-	1272
Mov Cap-2 Maneuver	208	-	-	-	-
Stage 1	759	-	-	-	-
Stage 2	386	-	-	-	-

Approach	WB	NB	SB
HCM Control Delay, s	10.1	0	1.3
HCM LOS	B		

Minor Lane/Major Mvmt	NBT	NBRWBLn1	SBL	SBT
Capacity (veh/h)	-	-	749	1272
HCM Lane V/C Ratio	-	-	0.065	0.088
HCM Control Delay (s)	-	-	10.1	8.1
HCM Lane LOS	-	-	B	A
HCM 95th %tile Q(veh)	-	-	0.2	0.3



# MOVEMENT SUMMARY

 Site: 101 [Wilson Gulch Dr & US 160 Ramps PM]

Roundabout

Movement Performance - Vehicles												
Mov ID	OD Mov	Demand Total veh/h	Flows HV %	Deg. Satn v/c	Average Delay sec	Level of Service	95% Back of Queue Vehicles veh	Distance ft	Prop. Queued	Effective Stop Rate per veh	Average Speed mph	
South: Wilson Gulch Dr												
3u	U	1	3.0	0.004	3.5	LOS A	0.0	0.4	0.36	0.17	35.1	
3	L2	1	3.0	0.004	3.5	LOS A	0.0	0.4	0.36	0.17	34.3	
8	T1	1	3.0	0.004	3.5	LOS A	0.0	0.4	0.36	0.17	34.2	
18	R2	1	3.0	0.004	3.5	LOS A	0.0	0.4	0.36	0.17	33.3	
Approach		4	3.0	0.004	3.5	LOS A	0.0	0.4	0.36	0.17	34.2	
East: US 160 WB Ramps												
1u	U	1	3.0	0.004	3.5	LOS A	0.0	0.4	0.36	0.17	35.1	
1	L2	1	3.0	0.004	3.5	LOS A	0.0	0.4	0.36	0.17	34.3	
6	T1	1	3.0	0.004	3.5	LOS A	0.0	0.4	0.36	0.17	34.2	
16	R2	1	3.0	0.004	3.5	LOS A	0.0	0.4	0.36	0.17	33.3	
Approach		4	3.0	0.004	3.5	LOS A	0.0	0.4	0.36	0.17	34.2	
North: Wilson Gulch Dr												
7u	U	147	3.0	0.152	4.0	LOS A	0.7	18.4	0.10	0.03	33.6	
7	L2	1	3.0	0.152	4.0	LOS A	0.7	18.4	0.10	0.03	32.9	
4	T1	50	3.0	0.152	4.0	LOS A	0.7	18.4	0.10	0.03	32.9	
14	R2	1	3.0	0.152	4.0	LOS A	0.7	18.4	0.10	0.03	32.0	
Approach		199	3.0	0.152	4.0	LOS A	0.7	18.4	0.10	0.03	33.4	
West: US 160 EB Off Ramp												
5u	U	14	3.0	0.081	3.8	LOS A	0.3	8.1	0.32	0.19	33.7	
5	L2	77	3.0	0.081	3.8	LOS A	0.3	8.1	0.32	0.19	32.9	
2	T1	1	3.0	0.081	3.8	LOS A	0.3	8.1	0.32	0.19	32.9	
12	R2	13	3.0	0.010	2.8	LOS A	0.0	1.0	0.14	0.04	35.3	
Approach		105	3.0	0.081	3.7	LOS A	0.3	8.1	0.30	0.17	33.3	
All Vehicles		313	3.0	0.152	3.9	LOS A	0.7	18.4	0.17	0.08	33.4	

Site Level of Service (LOS) Method: Delay & v/c (HCM 6). Site LOS Method is specified in the Parameter Settings dialog (Site tab).

Roundabout LOS Method: Same as Sign Control.

Vehicle movement LOS values are based on average delay and v/c ratio (degree of saturation) per movement.

LOS F will result if v/c > 1 irrespective of movement delay value (does not apply for approaches and intersection).

Intersection and Approach LOS values are based on average delay for all movements (v/c not used as specified in HCM 6).

Roundabout Capacity Model: US HCM 6.

























HCM Delay Formula option is used. Control Delay does not include Geometric Delay since Exclude Geometric Delay option applies.

Gap-Acceptance Capacity: Traditional M1.

HV (%) values are calculated for All Movement Classes of All Heavy Vehicle Model Designation.

























HCM 2010 Signalized Intersection Summary  
4: Three Springs Road & US 160

Existing Conditions Summer PM  
01/08/2019

												
Movement	EBL	EBT	EBR	WBL	WBT	WBR	NBL	NBT	NBR	SBL	SBT	SBR
Lane Configurations												
Traffic Volume (veh/h)	196	1379	7	18	693	66	13	10	18	199	8	414
Future Volume (veh/h)	196	1379	7	18	693	66	13	10	18	199	8	414
Number	1	6	16	5	2	12	3	8	18	7	4	14
Initial Q (Qb), veh	0	0	0	0	0	0	0	0	0	0	0	0
Ped-Bike Adj(A_pbT)	1.00		1.00	1.00		1.00	1.00		1.00	1.00		1.00
Parking Bus, Adj	1.00	1.00	1.00	1.00	1.00	1.00	1.00	1.00	1.00	1.00	1.00	1.00
Adj Sat Flow, veh/h/ln	1740	1707	1740	1740	1707	1740	1740	1740	1740	1740	1740	1740
Adj Flow Rate, veh/h	231	1622	0	19	729	0	23	18	0	243	10	0
Adj No. of Lanes	2	2	1	1	2	1	1	1	1	2	1	1
Peak Hour Factor	0.85	0.85	0.85	0.95	0.95	0.95	0.56	0.56	0.56	0.82	0.82	0.82
Percent Heavy Veh, %	2	4	2	2	4	2	2	2	2	2	2	2
Cap, veh/h	436	2273	1007	30	1891	833	169	70	45	363	87	59
Arrive On Green	0.14	0.70	0.00	0.02	0.58	0.00	0.06	0.04	0.00	0.07	0.05	0.00
Sat Flow, veh/h	3215	3243	1479	1657	3243	1479	1657	1740	1479	3215	1740	1479
Grp Volume(v), veh/h	231	1622	0	19	729	0	23	18	0	243	10	0
Grp Sat Flow(s),veh/h/ln	1608	1621	1479	1657	1621	1479	1657	1740	1479	1608	1740	1479
Q Serve(g_s), s	6.7	29.9	0.0	1.1	12.1	0.0	0.0	1.0	0.0	6.8	0.5	0.0
Cycle Q Clear(g_c), s	6.7	29.9	0.0	1.1	12.1	0.0	0.0	1.0	0.0	6.8	0.5	0.0
Prop In Lane	1.00		1.00	1.00		1.00	1.00		1.00	1.00		1.00
Lane Grp Cap(c), veh/h	436	2273	1007	30	1891	833	169	70	45	363	87	59
V/C Ratio(X)	0.53	0.71	0.00	0.64	0.39	0.00	0.14	0.26	0.00	0.67	0.11	0.00
Avail Cap(c_a), veh/h	436	2273	1007	96	1891	833	185	118	86	363	118	86
HCM Platoon Ratio	1.00	1.00	1.00	1.00	1.00	1.00	1.00	1.00	1.00	1.00	1.00	1.00
Upstream Filter(I)	1.00	1.00	0.00	1.00	1.00	0.00	1.00	1.00	0.00	1.00	1.00	0.00
Uniform Delay (d), s/veh	40.2	9.0	0.0	48.8	11.2	0.0	44.3	46.5	0.0	46.9	45.4	0.0
Incr Delay (d2), s/veh	0.8	1.9	0.0	13.2	0.6	0.0	0.2	1.2	0.0	4.2	0.4	0.0
Initial Q Delay(d3),s/veh	0.0	0.0	0.0	0.0	0.0	0.0	0.0	0.0	0.0	0.0	0.0	0.0
%ile BackOfQ(50%),veh/ln	3.0	13.9	0.0	0.6	5.5	0.0	0.6	0.5	0.0	0.5	0.3	0.0
LnGrp Delay(d),s/veh	41.1	10.9	0.0	62.0	11.8	0.0	44.6	47.7	0.0	51.0	45.7	0.0
LnGrp LOS	D	B		E	B		D	D		D	D	
Approach Vol, veh/h		1853			748			41			253	
Approach Delay, s/veh		14.7			13.1			45.9			50.8	
Approach LOS		B			B			D			D	
Timer	1	2	3	4	5	6	7	8				
Assigned Phs	1	2	3	4	5	6	7	8				
Phs Duration (G+Y+Rc), s	18.8	62.0	10.0	9.2	7.0	73.8	11.0	8.2				
Change Period (Y+Rc), s	5.7	5.7	* 5.2	* 5.2	5.7	5.7	* 5.2	* 5.2				
Max Green Setting (Gmax), s	10.3	56.3	* 5.8	* 5.8	5.3	61.3	* 5.8	* 5.8				
Max Q Clear Time (g_c+1), s	8.7	14.1	2.0	2.5	3.1	31.9	8.8	3.0				
Green Ext Time (p_c), s	0.1	3.5	0.0	0.0	0.0	11.4	0.0	0.0				
<b>Intersection Summary</b>												
HCM 2010 Ctrl Delay				17.9								
HCM 2010 LOS				B								
<b>Notes</b>												

HCM 2010 Signalized Intersection Summary  
5: SH 172/CR 234 & US 160

Existing Conditions Summer PM  
01/08/2019







												
Movement	EBL	EBT	EBR	WBL	WBT	WBR	NBL	NBT	NBR	SBL	SBT	SBR
Lane Configurations												
Traffic Volume (veh/h)	221	906	486	41	313	35	330	69	63	52	53	82
Future Volume (veh/h)	221	906	486	41	313	35	330	69	63	52	53	82
Number	1	6	16	5	2	12	3	8	18	7	4	14
Initial Q (Qb), veh	0	0	0	0	0	0	0	0	0	0	0	0
Ped-Bike Adj(A_pbT)	1.00		1.00	1.00		1.00	1.00		1.00	1.00		1.00
Parking Bus, Adj	1.00	1.00	1.00	1.00	1.00	1.00	1.00	1.00	1.00	1.00	1.00	1.00
Adj Sat Flow, veh/h/ln	1740	1690	1740	1740	1690	1740	1740	1740	1740	1740	1740	1740
Adj Flow Rate, veh/h	235	964	0	48	368	0	422	0	0	59	60	0
Adj No. of Lanes	1	2	1	1	2	1	2	0	1	1	1	1
Peak Hour Factor	0.94	0.94	0.94	0.85	0.85	0.85	0.90	0.90	0.90	0.88	0.88	0.88
Percent Heavy Veh, %	2	5	2	2	5	2	2	2	2	2	2	2
Cap, veh/h	656	1800	829	68	1658	763	533	0	223	105	110	78
Arrive On Green	0.09	0.56	0.00	0.04	0.52	0.00	0.16	0.00	0.00	0.06	0.06	0.00
Sat Flow, veh/h	1657	3212	1479	1657	3212	1479	3315	0	1479	1657	1740	1479
Grp Volume(v), veh/h	235	964	0	48	368	0	422	0	0	59	60	0
Grp Sat Flow(s),veh/h/ln	1657	1606	1479	1657	1606	1479	1657	0	1479	1657	1740	1479
Q Serve(g_s), s	6.7	18.9	0.0	2.9	6.3	0.0	12.2	0.0	0.0	3.5	3.3	0.0
Cycle Q Clear(g_c), s	6.7	18.9	0.0	2.9	6.3	0.0	12.2	0.0	0.0	3.5	3.3	0.0
Prop In Lane	1.00		1.00	1.00		1.00	1.00		1.00	1.00		1.00
Lane Grp Cap(c), veh/h	656	1800	829	68	1658	763	533	0	223	105	110	78
V/C Ratio(X)	0.36	0.54	0.00	0.71	0.22	0.00	0.79	0.00	0.00	0.56	0.55	0.00
Avail Cap(c_a), veh/h	656	1800	829	141	1658	763	762	0	325	149	157	118
HCM Platoon Ratio	1.00	1.00	1.00	1.00	1.00	1.00	1.00	1.00	1.00	1.00	1.00	1.00
Upstream Filter(I)	1.00	1.00	0.00	1.00	1.00	0.00	1.00	0.00	0.00	1.00	1.00	0.00
Uniform Delay (d), s/veh	9.9	13.8	0.0	47.4	13.2	0.0	40.4	0.0	0.0	45.5	45.5	0.0
Incr Delay (d2), s/veh	0.2	1.1	0.0	8.0	0.3	0.0	2.8	0.0	0.0	2.9	2.6	0.0
Initial Q Delay(d3),s/veh	0.0	0.0	0.0	0.0	0.0	0.0	0.0	0.0	0.0	0.0	0.0	0.0
%ile BackOfQ(50%),veh/ln	3.0	8.6	0.0	1.5	2.8	0.0	5.8	0.0	0.0	1.7	1.7	0.0
LnGrp Delay(d),s/veh	10.1	15.0	0.0	55.4	13.5	0.0	43.2	0.0	0.0	48.4	48.0	0.0
LnGrp LOS	B	B		E	B		D			D	D	
Approach Vol, veh/h		1199			416			422			119	
Approach Delay, s/veh		14.0			18.4			43.2			48.2	
Approach LOS		B			B			D			D	
Timer	1	2	3	4	5	6	7	8				
Assigned Phs	1	2		4	5	6		8				
Phs Duration (G+Y+Rc), s	14.0	55.6		10.3	9.6	60.0		20.1				
Change Period (Y+Rc), s	6.0	6.0		5.0	6.0	6.0		5.0				
Max Green Setting (Gmax), s	8.0	40.0		8.0	8.0	40.0		22.0				
Max Q Clear Time (g_c+I1), s	8.7	8.3		5.5	4.9	20.9		14.2				
Green Ext Time (p_c), s	0.0	24.5		0.0	0.0	16.0		0.8				
<b>Intersection Summary</b>												
HCM 2010 Ctrl Delay				22.4								
HCM 2010 LOS				C								
<b>Notes</b>												

Intersection												
Int Delay, s/veh	1.8											
Movement	EBL	EBT	EBR	WBL	WBT	WBR	NBL	NBT	NBR	SBL	SBT	SBR
Lane Configurations		↑	↗		↕		↖	↑	↗	↖	↑	↗
Traffic Vol, veh/h	21	2	43	5	5	28	20	331	5	38	407	36
Future Vol, veh/h	21	2	43	5	5	28	20	331	5	38	407	36
Conflicting Peds, #/hr	0	0	0	0	0	0	0	0	0	0	0	0
Sign Control	Stop	Stop	Stop	Stop	Stop	Stop	Free	Free	Free	Free	Free	Free
RT Channelized	-	-	Stop	-	-	None	-	-	None	-	-	None
Storage Length	-	-	170	-	-	-	140	-	280	540	-	430
Veh in Median Storage, #	-	0	-	-	0	-	-	0	-	-	0	-
Grade, %	-	0	-	-	0	-	-	0	-	-	0	-
Peak Hour Factor	94	94	94	94	94	94	94	94	94	94	94	94
Heavy Vehicles, %	2	2	2	2	2	2	2	2	2	2	2	2
Mvmt Flow	22	2	46	5	5	30	21	352	5	40	433	38

Major/Minor	Minor2		Minor1		Major1		Major2					
Conflicting Flow All	926	909	433	910	909	352	433	0	0	352	0	0
Stage 1	514	514	-	395	395	-	-	-	-	-	-	-
Stage 2	412	395	-	515	514	-	-	-	-	-	-	-
Critical Hdwy	7.12	6.52	6.22	7.12	6.52	6.22	4.12	-	-	4.12	-	-
Critical Hdwy Stg 1	6.12	5.52	-	6.12	5.52	-	-	-	-	-	-	-
Critical Hdwy Stg 2	6.12	5.52	-	6.12	5.52	-	-	-	-	-	-	-
Follow-up Hdwy	3.518	4.018	3.318	3.518	4.018	3.318	2.218	-	-	2.218	-	-
Pot Cap-1 Maneuver	249	275	623	255	275	692	1127	-	-	1207	-	-
Stage 1	543	535	-	630	605	-	-	-	-	-	-	-
Stage 2	617	605	-	543	535	-	-	-	-	-	-	-
Platoon blocked, %								-	-	-	-	-
Mov Cap-1 Maneuver	225	261	623	226	261	692	1127	-	-	1207	-	-
Mov Cap-2 Maneuver	225	261	-	226	261	-	-	-	-	-	-	-
Stage 1	533	517	-	618	594	-	-	-	-	-	-	-
Stage 2	574	594	-	484	517	-	-	-	-	-	-	-

Approach	EB		WB		NB		SB	
HCM Control Delay, s	11.5		13.5		0.5		0.6	
HCM LOS	B		B					

Minor Lane/Major Mvmt	NBL	NBT	NBR	EBLn1	EBLn2	WBLn1	SBL	SBT	SBR
Capacity (veh/h)	1127	-	-	261	623	465	1207	-	-
HCM Lane V/C Ratio	0.019	-	-	0.008	0.073	0.087	0.033	-	-
HCM Control Delay (s)	8.3	-	-	18.9	11.2	13.5	8.1	-	-
HCM Lane LOS	A	-	-	C	B	B	A	-	-
HCM 95th %tile Q(veh)	0.1	-	-	0	0.2	0.3	0.1	-	-

								
Movement	EBT	EBR	WBL	WBT	NBL	NBR		
Lane Configurations	↑↑	↑	↑	↑↑	↑	↑		
Traffic Volume (veh/h)	779	165	24	1353	487	89		
Future Volume (veh/h)	779	165	24	1353	487	89		
Number	6	16	5	2	3	18		
Initial Q (Qb), veh	0	0	0	0	0	0		
Ped-Bike Adj(A_pbT)		1.00	1.00		1.00	1.00		
Parking Bus, Adj	1.00	1.00	1.00	1.00	1.00	1.00		
Adj Sat Flow, veh/h/ln	1863	1863	1863	1863	1863	1863		
Adj Flow Rate, veh/h	950	0	29	1650	594	109		
Adj No. of Lanes	2	1	1	2	1	1		
Peak Hour Factor	0.82	0.82	0.82	0.82	0.82	0.82		
Percent Heavy Veh, %	2	2	2	2	2	2		
Cap, veh/h	1143	511	36	0	631	595		
Arrive On Green	0.32	0.00	0.02	0.00	0.36	0.36		
Sat Flow, veh/h	3632	1583	1774	29	1774	1583		
Grp Volume(v), veh/h	950	0	29	71.5	594	109		
Grp Sat Flow(s),veh/h/ln	1770	1583	1774	E	1774	1583		
Q Serve(g_s), s	24.8	0.0	1.6		32.4	2.6		
Cycle Q Clear(g_c), s	24.8	0.0	1.6		32.4	2.6		
Prop In Lane		1.00	1.00		1.00	1.00		
Lane Grp Cap(c), veh/h	1143	511	36		631	595		
V/C Ratio(X)	0.83	0.00	0.81		0.94	0.18		
Avail Cap(c_a), veh/h	1143	511	165		745	697		
HCM Platoon Ratio	1.00	1.00	1.00		1.00	1.00		
Upstream Filter(I)	1.00	0.00	1.00		1.00	1.00		
Uniform Delay (d), s/veh	31.3	0.0	48.8		31.2	20.9		
Incr Delay (d2), s/veh	7.1	0.0	22.7		17.8	0.1		
Initial Q Delay(d3),s/veh	0.0	0.0	0.0		0.0	0.0		
%ile BackOfQ(50%),veh/ln	13.3	0.0	1.0		19.0	1.1		
LnGrp Delay(d),s/veh	38.4	0.0	71.5		49.1	21.0		
LnGrp LOS	D		E		D	C		
Approach Vol, veh/h	950				703			
Approach Delay, s/veh	38.4				44.7			
Approach LOS	D				D			
Timer	1	2	3	4	5	6	7	8
Assigned Phs					5	6		8
Phs Duration (G+Y+Rc), s					7.7	38.0		40.5
Change Period (Y+Rc), s					5.7	5.7		5.0
Max Green Setting (Gmax), s					9.3	32.3		42.0
Max Q Clear Time (g_c+I1), s					3.6	26.8		34.4
Green Ext Time (p_c), s					0.0	3.1		1.1
<b>Intersection Summary</b>								
HCM 2010 Ctrl Delay			41.6					
HCM 2010 LOS			D					

Intersection						
Int Delay, s/veh	1.5					
Movement	WBL	WBR	NBT	NBR	SBL	SBT
Lane Configurations	↔		↔			↑
Traffic Vol, veh/h	0	69	475	0	24	159
Future Vol, veh/h	0	69	475	0	24	159
Conflicting Peds, #/hr	0	0	0	0	0	0
Sign Control	Stop	Stop	Free	Free	Free	Free
RT Channelized	-	None	-	None	-	None
Storage Length	0	-	-	-	-	-
Veh in Median Storage, #	0	-	0	-	-	0
Grade, %	0	-	0	-	-	0
Peak Hour Factor	88	88	88	88	88	88
Heavy Vehicles, %	2	2	2	2	2	2
Mvmt Flow	0	78	540	0	27	181

Major/Minor	Minor1	Major1	Major2			
Conflicting Flow All	775	540	0	0	540	0
Stage 1	540	-	-	-	-	-
Stage 2	235	-	-	-	-	-
Critical Hdwy	6.42	6.22	-	-	4.12	-
Critical Hdwy Stg 1	5.42	-	-	-	-	-
Critical Hdwy Stg 2	5.42	-	-	-	-	-
Follow-up Hdwy	3.518	3.318	-	-	2.218	-
Pot Cap-1 Maneuver	366	542	-	-	1028	-
Stage 1	584	-	-	-	-	-
Stage 2	804	-	-	-	-	-
Platoon blocked, %			-	-		-
Mov Cap-1 Maneuver	355	542	-	-	1028	-
Mov Cap-2 Maneuver	355	-	-	-	-	-
Stage 1	584	-	-	-	-	-
Stage 2	781	-	-	-	-	-

Approach	WB	NB	SB
HCM Control Delay, s	12.8	0	1.1
HCM LOS	B		

Minor Lane/Major Mvmt	NBT	NBRWBLn1	SBL	SBT
Capacity (veh/h)	-	-	542	1028
HCM Lane V/C Ratio	-	-	0.145	0.027
HCM Control Delay (s)	-	-	12.8	8.6
HCM Lane LOS	-	-	B	A
HCM 95th %tile Q(veh)	-	-	0.5	0.1

# MOVEMENT SUMMARY

 Site: 101 [Wilson Gulch Dr & US 160 Ramps AM]

Roundabout

Movement Performance - Vehicles												
Mov ID	OD Mov	Demand Total veh/h	Flows HV %	Deg. Satn v/c	Average Delay sec	Level of Service	95% Back of Queue Vehicles veh	Distance ft	Prop. Queued	Effective Stop Rate per veh	Average Speed mph	
South: Wilson Gulch Dr												
3u	U	1	3.0	0.004	3.6	LOS A	0.0	0.4	0.37	0.19	35.1	
3	L2	1	3.0	0.004	3.6	LOS A	0.0	0.4	0.37	0.19	34.2	
8	T1	1	3.0	0.004	3.6	LOS A	0.0	0.4	0.37	0.19	34.2	
18	R2	1	3.0	0.004	3.6	LOS A	0.0	0.4	0.37	0.19	33.2	
Approach		4	3.0	0.004	3.6	LOS A	0.0	0.4	0.37	0.19	34.2	
East: US 160 WB Ramps												
1u	U	1	3.0	0.005	3.6	LOS A	0.0	0.5	0.37	0.19	35.4	
1	L2	1	3.0	0.005	3.6	LOS A	0.0	0.5	0.37	0.19	34.6	
6	T1	1	3.0	0.005	3.6	LOS A	0.0	0.5	0.37	0.19	34.5	
16	R2	2	3.0	0.005	3.6	LOS A	0.0	0.5	0.37	0.19	33.5	
Approach		5	3.0	0.005	3.6	LOS A	0.0	0.5	0.37	0.19	34.3	
North: Wilson Gulch Dr												
7u	U	58	3.0	0.062	3.2	LOS A	0.3	6.8	0.06	0.01	34.1	
7	L2	1	3.0	0.062	3.2	LOS A	0.3	6.8	0.06	0.01	33.4	
4	T1	22	3.0	0.062	3.2	LOS A	0.3	6.8	0.06	0.01	33.3	
14	R2	1	3.0	0.062	3.2	LOS A	0.3	6.8	0.06	0.01	32.4	
Approach		82	3.0	0.062	3.2	LOS A	0.3	6.8	0.06	0.01	33.9	
West: US 160 EB Off Ramp												
5u	U	5	3.0	0.157	4.1	LOS A	0.7	17.3	0.21	0.10	33.6	
5	L2	193	3.0	0.157	4.1	LOS A	0.7	17.3	0.21	0.10	32.9	
2	T1	1	3.0	0.157	4.1	LOS A	0.7	17.3	0.21	0.10	32.8	
12	R2	10	3.0	0.007	2.7	LOS A	0.0	0.7	0.09	0.02	35.4	
Approach		210	3.0	0.157	4.1	LOS A	0.7	17.3	0.21	0.09	33.0	
All Vehicles		301	3.0	0.157	3.8	LOS A	0.7	17.3	0.17	0.08	33.3	

Site Level of Service (LOS) Method: Delay & v/c (HCM 6). Site LOS Method is specified in the Parameter Settings dialog (Site tab).

Roundabout LOS Method: Same as Sign Control.

Vehicle movement LOS values are based on average delay and v/c ratio (degree of saturation) per movement.

LOS F will result if v/c > 1 irrespective of movement delay value (does not apply for approaches and intersection).

Intersection and Approach LOS values are based on average delay for all movements (v/c not used as specified in HCM 6).

Roundabout Capacity Model: US HCM 6.

HCM Delay Formula option is used. Control Delay does not include Geometric Delay since Exclude Geometric Delay option applies.

























Gap-Acceptance Capacity: Traditional M1.

























HV (%) values are calculated for All Movement Classes of All Heavy Vehicle Model Designation.



HCM 2010 Signalized Intersection Summary  
4: Three Springs Road & US 160

Existing Conditions Winter AM  
01/08/2019

												
Movement	EBL	EBT	EBR	WBL	WBT	WBR	NBL	NBT	NBR	SBL	SBT	SBR
Lane Configurations												
Traffic Volume (veh/h)	364	434	2	24	1321	233	26	8	10	52	3	130
Future Volume (veh/h)	364	434	2	24	1321	233	26	8	10	52	3	130
Number	1	6	16	5	2	12	3	8	18	7	4	14
Initial Q (Qb), veh	0	0	0	0	0	0	0	0	0	0	0	0
Ped-Bike Adj(A_pbT)	1.00		1.00	1.00		1.00	1.00		1.00	1.00		1.00
Parking Bus, Adj	1.00	1.00	1.00	1.00	1.00	1.00	1.00	1.00	1.00	1.00	1.00	1.00
Adj Sat Flow, veh/h/ln	1740	1707	1740	1740	1707	1740	1740	1740	1740	1740	1740	1740
Adj Flow Rate, veh/h	423	505	0	31	1716	0	38	12	0	68	4	0
Adj No. of Lanes	2	2	1	1	2	1	1	1	1	2	1	1
Peak Hour Factor	0.86	0.86	0.86	0.77	0.77	0.77	0.69	0.69	0.69	0.77	0.77	0.77
Percent Heavy Veh, %	2	4	2	2	4	2	2	2	2	2	2	2
Cap, veh/h	571	2345	1040	45	1858	818	177	71	46	351	80	53
Arrive On Green	0.18	0.72	0.00	0.03	0.57	0.00	0.03	0.04	0.00	0.04	0.05	0.00
Sat Flow, veh/h	3215	3243	1479	1657	3243	1479	1657	1740	1479	3215	1740	1479
Grp Volume(v), veh/h	423	505	0	31	1716	0	38	12	0	68	4	0
Grp Sat Flow(s),veh/h/ln	1608	1621	1479	1657	1621	1479	1657	1740	1479	1608	1740	1479
Q Serve(g_s), s	12.5	5.1	0.0	1.9	48.0	0.0	0.0	0.7	0.0	0.0	0.2	0.0
Cycle Q Clear(g_c), s	12.5	5.1	0.0	1.9	48.0	0.0	0.0	0.7	0.0	0.0	0.2	0.0
Prop In Lane	1.00		1.00	1.00		1.00	1.00		1.00	1.00		1.00
Lane Grp Cap(c), veh/h	571	2345	1040	45	1858	818	177	71	46	351	80	53
V/C Ratio(X)	0.74	0.22	0.00	0.69	0.92	0.00	0.21	0.17	0.00	0.19	0.05	0.00
Avail Cap(c_a), veh/h	571	2345	1040	96	1858	818	239	118	86	456	118	86
HCM Platoon Ratio	1.00	1.00	1.00	1.00	1.00	1.00	1.00	1.00	1.00	1.00	1.00	1.00
Upstream Filter(I)	1.00	1.00	0.00	1.00	1.00	0.00	1.00	1.00	0.00	1.00	1.00	0.00
Uniform Delay (d), s/veh	39.0	4.5	0.0	48.2	19.4	0.0	44.5	46.3	0.0	44.4	45.6	0.0
Incr Delay (d2), s/veh	4.8	0.2	0.0	10.7	9.2	0.0	0.4	0.7	0.0	0.2	0.2	0.0
Initial Q Delay(d3),s/veh	0.0	0.0	0.0	0.0	0.0	0.0	0.0	0.0	0.0	0.0	0.0	0.0
%ile BackOfQ(50%),veh/ln	5.9	2.3	0.0	1.0	23.6	0.0	1.0	0.3	0.0	0.9	0.1	0.0
LnGrp Delay(d),s/veh	43.7	4.7	0.0	58.9	28.6	0.0	44.9	47.0	0.0	44.5	45.8	0.0
LnGrp LOS	D	A		E	C		D	D		D	D	
Approach Vol, veh/h		928			1747			50			72	
Approach Delay, s/veh		22.5			29.1			45.4			44.6	
Approach LOS		C			C			D			D	
Timer	1	2	3	4	5	6	7	8				
Assigned Phs	1	2	3	4	5	6	7	8				
Phs Duration (G+Y+Rc), s	22.9	61.0	7.2	8.8	7.9	76.0	7.7	8.3				
Change Period (Y+Rc), s	5.7	5.7	* 5.2	* 5.2	5.7	5.7	* 5.2	* 5.2				
Max Green Setting (Gmax), s	11.3	55.3	* 5.8	* 5.8	5.3	61.3	* 5.8	* 5.8				
Max Q Clear Time (g_c+I1), s	14.5	50.0	2.0	2.2	3.9	7.1	2.0	2.7				
Green Ext Time (p_c), s	0.0	3.8	0.1	0.0	0.0	3.5	0.1	0.0				
<b>Intersection Summary</b>												
HCM 2010 Ctrl Delay			27.6									
HCM 2010 LOS			C									
<b>Notes</b>												







												
Movement	EBL	EBT	EBR	WBL	WBT	WBR	NBL	NBT	NBR	SBL	SBT	SBR
Lane Configurations												
Traffic Volume (veh/h)	34	217	218	72	866	16	496	36	34	18	52	189
Future Volume (veh/h)	34	217	218	72	866	16	496	36	34	18	52	189
Number	1	6	16	5	2	12	3	8	18	7	4	14
Initial Q (Qb), veh	0	0	0	0	0	0	0	0	0	0	0	0
Ped-Bike Adj(A_pbT)	1.00		1.00	1.00		1.00	1.00		1.00	1.00		1.00
Parking Bus, Adj	1.00	1.00	1.00	1.00	1.00	1.00	1.00	1.00	1.00	1.00	1.00	1.00
Adj Sat Flow, veh/h/ln	1740	1690	1740	1740	1690	1740	1740	1740	1740	1740	1740	1740
Adj Flow Rate, veh/h	36	228	0	95	1139	0	705	0	0	23	66	0
Adj No. of Lanes	1	2	1	1	2	1	2	0	1	1	1	1
Peak Hour Factor	0.95	0.95	0.95	0.76	0.76	0.76	0.74	0.74	0.74	0.79	0.79	0.79
Percent Heavy Veh, %	2	5	2	2	5	2	2	2	2	2	2	2
Cap, veh/h	52	1579	727	658	1641	756	729	0	311	104	109	78
Arrive On Green	0.03	0.49	0.00	0.05	0.51	0.00	0.22	0.00	0.00	0.06	0.06	0.00
Sat Flow, veh/h	1657	3212	1479	1657	3212	1479	3315	0	1479	1657	1740	1479
Grp Volume(v), veh/h	36	228	0	95	1139	0	705	0	0	23	66	0
Grp Sat Flow(s),veh/h/ln	1657	1606	1479	1657	1606	1479	1657	0	1479	1657	1740	1479
Q Serve(g_s), s	2.2	3.9	0.0	2.9	26.9	0.0	21.1	0.0	0.0	1.3	3.7	0.0
Cycle Q Clear(g_c), s	2.2	3.9	0.0	2.9	26.9	0.0	21.1	0.0	0.0	1.3	3.7	0.0
Prop In Lane	1.00		1.00	1.00		1.00	1.00		1.00	1.00		1.00
Lane Grp Cap(c), veh/h	52	1579	727	658	1641	756	729	0	311	104	109	78
V/C Ratio(X)	0.69	0.14	0.00	0.14	0.69	0.00	0.97	0.00	0.00	0.22	0.60	0.00
Avail Cap(c_a), veh/h	108	1579	727	682	1641	756	729	0	311	232	244	192
HCM Platoon Ratio	1.00	1.00	1.00	1.00	1.00	1.00	1.00	1.00	1.00	1.00	1.00	1.00
Upstream Filter(I)	1.00	1.00	0.00	1.00	1.00	0.00	1.00	0.00	0.00	1.00	1.00	0.00
Uniform Delay (d), s/veh	48.0	13.9	0.0	11.9	18.5	0.0	38.6	0.0	0.0	44.5	45.6	0.0
Incr Delay (d2), s/veh	9.7	0.2	0.0	0.1	2.4	0.0	25.2	0.0	0.0	0.6	3.2	0.0
Initial Q Delay(d3),s/veh	0.0	0.0	0.0	0.0	0.0	0.0	0.0	0.0	0.0	0.0	0.0	0.0
%ile BackOfQ(50%),veh/ln	1.1	1.8	0.0	1.3	12.4	0.0	12.1	0.0	0.0	0.6	1.9	0.0
LnGrp Delay(d),s/veh	57.7	14.1	0.0	12.0	21.0	0.0	63.8	0.0	0.0	45.2	48.9	0.0
LnGrp LOS	E	B		B	C		E			D	D	
Approach Vol, veh/h		264			1234			705			89	
Approach Delay, s/veh		20.0			20.3			63.8			47.9	
Approach LOS		C			C			E			D	
Timer	1	2	3	4	5	6	7	8				
Assigned Phs	1	2		4	5	6		8				
Phs Duration (G+Y+Rc), s	8.6	55.1		10.3	10.5	53.2		26.0				
Change Period (Y+Rc), s	6.0	6.0		5.0	6.0	6.0		5.0				
Max Green Setting (Gmax), s	6.0	38.0		13.0	6.0	38.0		21.0				
Max Q Clear Time (g_c+I1), s	4.2	28.9		5.7	4.9	5.9		23.1				
Green Ext Time (p_c), s	0.0	8.3		0.1	0.0	26.1		0.0				
<b>Intersection Summary</b>												
HCM 2010 Ctrl Delay				34.7								
HCM 2010 LOS				C								
<b>Notes</b>												

Intersection												
Int Delay, s/veh	2.2											
Movement	EBL	EBT	EBR	WBL	WBT	WBR	NBL	NBT	NBR	SBL	SBT	SBR
Lane Configurations		↑	↗		↕		↖	↑	↗	↖	↑	↗
Traffic Vol, veh/h	37	4	10	3	4	59	17	392	2	17	240	20
Future Vol, veh/h	37	4	10	3	4	59	17	392	2	17	240	20
Conflicting Peds, #/hr	0	0	0	0	0	0	0	0	0	0	0	0
Sign Control	Stop	Stop	Stop	Stop	Stop	Stop	Free	Free	Free	Free	Free	Free
RT Channelized	-	-	Stop	-	-	None	-	-	None	-	-	None
Storage Length	-	-	170	-	-	-	140	-	280	540	-	430
Veh in Median Storage, #	-	0	-	-	0	-	-	0	-	-	0	-
Grade, %	-	0	-	-	0	-	-	0	-	-	0	-
Peak Hour Factor	81	81	81	81	81	81	81	81	81	81	81	81
Heavy Vehicles, %	2	2	2	2	2	2	2	2	2	2	2	2
Mvmt Flow	46	5	12	4	5	73	21	484	2	21	296	25

Major/Minor	Minor2		Minor1		Major1		Major2					
Conflicting Flow All	903	864	296	867	864	484	296	0	0	484	0	0
Stage 1	338	338	-	526	526	-	-	-	-	-	-	-
Stage 2	565	526	-	341	338	-	-	-	-	-	-	-
Critical Hdwy	7.12	6.52	6.22	7.12	6.52	6.22	4.12	-	-	4.12	-	-
Critical Hdwy Stg 1	6.12	5.52	-	6.12	5.52	-	-	-	-	-	-	-
Critical Hdwy Stg 2	6.12	5.52	-	6.12	5.52	-	-	-	-	-	-	-
Follow-up Hdwy	3.518	4.018	3.318	3.518	4.018	3.318	2.218	-	-	2.218	-	-
Pot Cap-1 Maneuver	258	292	743	273	292	583	1265	-	-	1079	-	-
Stage 1	676	641	-	535	529	-	-	-	-	-	-	-
Stage 2	510	529	-	674	641	-	-	-	-	-	-	-
Platoon blocked, %								-	-	-	-	-
Mov Cap-1 Maneuver	217	282	743	258	282	583	1265	-	-	1079	-	-
Mov Cap-2 Maneuver	217	282	-	258	282	-	-	-	-	-	-	-
Stage 1	665	629	-	526	520	-	-	-	-	-	-	-
Stage 2	435	520	-	645	629	-	-	-	-	-	-	-

Approach	EB	WB	NB	SB
HCM Control Delay, s	12.2	13.2	0.3	0.5
HCM LOS	B	B		

Minor Lane/Major Mvmt	NBL	NBT	NBR	EBLn1	EBLn2	WBLn1	SBL	SBT	SBR
Capacity (veh/h)	1265	-	-	282	743	520	1079	-	-
HCM Lane V/C Ratio	0.017	-	-	0.018	0.017	0.157	0.019	-	-
HCM Control Delay (s)	7.9	-	-	18	9.9	13.2	8.4	-	-
HCM Lane LOS	A	-	-	C	A	B	A	-	-
HCM 95th %tile Q(veh)	0.1	-	-	0.1	0.1	0.6	0.1	-	-

								
Movement	EBT	EBR	WBL	WBT	NBL	NBR		
Lane Configurations	↑↑	↑	↑	↑↑	↑	↑		
Traffic Volume (veh/h)	1268	438	74	1047	211	54		
Future Volume (veh/h)	1268	438	74	1047	211	54		
Number	6	16	5	2	3	18		
Initial Q (Qb), veh	0	0	0	0	0	0		
Ped-Bike Adj(A_pbT)		1.00	1.00		1.00	1.00		
Parking Bus, Adj	1.00	1.00	1.00	1.00	1.00	1.00		
Adj Sat Flow, veh/h/ln	1863	1863	1863	1863	1863	1863		
Adj Flow Rate, veh/h	1546	0	90	1277	257	0		
Adj No. of Lanes	2	1	1	2	1	1		
Peak Hour Factor	0.82	0.82	0.82	0.82	0.82	0.82		
Percent Heavy Veh, %	2	2	2	2	2	2		
Cap, veh/h	1886	844	115	0	291	362		
Arrive On Green	0.53	0.00	0.06	0.00	0.16	0.00		
Sat Flow, veh/h	3632	1583	1774	90	1774	1583		
Grp Volume(v), veh/h	1546	0	90	53.2	257	0		
Grp Sat Flow(s),veh/h/ln	1770	1583	1774	D	1774	1583		
Q Serve(g_s), s	36.2	0.0	5.0		14.2	0.0		
Cycle Q Clear(g_c), s	36.2	0.0	5.0		14.2	0.0		
Prop In Lane		1.00	1.00		1.00	1.00		
Lane Grp Cap(c), veh/h	1886	844	115		291	362		
V/C Ratio(X)	0.82	0.00	0.79		0.88	0.00		
Avail Cap(c_a), veh/h	1886	844	190		385	446		
HCM Platoon Ratio	1.00	1.00	1.00		1.00	1.00		
Upstream Filter(I)	1.00	0.00	1.00		1.00	0.00		
Uniform Delay (d), s/veh	19.4	0.0	46.1		40.9	0.0		
Incr Delay (d2), s/veh	4.1	0.0	7.1		15.3	0.0		
Initial Q Delay(d3),s/veh	0.0	0.0	0.0		0.0	0.0		
%ile BackOfQ(50%),veh/ln	18.7	0.0	2.7		8.2	0.0		
LnGrp Delay(d),s/veh	23.5	0.0	53.2		56.2	0.0		
LnGrp LOS	C		D		E			
Approach Vol, veh/h	1546				257			
Approach Delay, s/veh	23.5				56.2			
Approach LOS	C				E			
Timer	1	2	3	4	5	6	7	8
Assigned Phs					5	6		8
Phs Duration (G+Y+Rc), s					10.8	59.0		20.7
Change Period (Y+Rc), s					4.3	* 5.7		4.3
Max Green Setting (Gmax), s					10.7	* 53		21.7
Max Q Clear Time (g_c+I1), s					7.0	38.2		16.2
Green Ext Time (p_c), s					0.0	10.5		0.2
<b>Intersection Summary</b>								
HCM 2010 Ctrl Delay			29.3					
HCM 2010 LOS			C					
<b>Notes</b>								

Intersection						
Int Delay, s/veh	1.3					
Movement	WBL	WBR	NBT	NBR	SBL	SBT
Lane Configurations	↔		↔			↑
Traffic Vol, veh/h	0	37	222	0	86	438
Future Vol, veh/h	0	37	222	0	86	438
Conflicting Peds, #/hr	0	0	0	0	0	0
Sign Control	Stop	Stop	Free	Free	Free	Free
RT Channelized	-	None	-	None	-	None
Storage Length	0	-	-	-	-	-
Veh in Median Storage, #	0	-	0	-	-	0
Grade, %	0	-	0	-	-	0
Peak Hour Factor	88	88	88	88	88	88
Heavy Vehicles, %	2	2	2	2	2	2
Mvmt Flow	0	42	252	0	98	498

Major/Minor	Minor1	Major1	Major2			
Conflicting Flow All	945	252	0	0	252	0
Stage 1	252	-	-	-	-	-
Stage 2	693	-	-	-	-	-
Critical Hdwy	6.42	6.22	-	-	4.12	-
Critical Hdwy Stg 1	5.42	-	-	-	-	-
Critical Hdwy Stg 2	5.42	-	-	-	-	-
Follow-up Hdwy	3.518	3.318	-	-	2.218	-
Pot Cap-1 Maneuver	291	787	-	-	1313	-
Stage 1	790	-	-	-	-	-
Stage 2	496	-	-	-	-	-
Platoon blocked, %			-	-		-
Mov Cap-1 Maneuver	261	787	-	-	1313	-
Mov Cap-2 Maneuver	261	-	-	-	-	-
Stage 1	790	-	-	-	-	-
Stage 2	445	-	-	-	-	-

Approach	WB	NB	SB
HCM Control Delay, s	9.8	0	1.3
HCM LOS	A		

Minor Lane/Major Mvmt	NBT	NBRWBLn1	SBL	SBT
Capacity (veh/h)	-	-	787	1313
HCM Lane V/C Ratio	-	-	0.053	0.074
HCM Control Delay (s)	-	-	9.8	8
HCM Lane LOS	-	-	A	A
HCM 95th %tile Q(veh)	-	-	0.2	0.2

# MOVEMENT SUMMARY

 Site: 101 [Wilson Gulch Dr & US 160 Ramps PM]

Roundabout

Movement Performance - Vehicles												
Mov ID	OD Mov	Demand Total veh/h	Flows HV %	Deg. Satn v/c	Average Delay sec	Level of Service	95% Back of Queue Vehicles veh	of Queue Distance ft	Prop. Queued	Effective Stop Rate per veh	Average Speed mph	
South: Wilson Gulch Dr												
3u	U	1	3.0	0.004	3.4	LOS A	0.0	0.4	0.33	0.15	35.2	
3	L2	1	3.0	0.004	3.4	LOS A	0.0	0.4	0.33	0.15	34.3	
8	T1	1	3.0	0.004	3.4	LOS A	0.0	0.4	0.33	0.15	34.3	
18	R2	1	3.0	0.004	3.4	LOS A	0.0	0.4	0.33	0.15	33.3	
Approach		4	3.0	0.004	3.4	LOS A	0.0	0.4	0.33	0.15	34.3	
East: US 160 WB Ramps												
1u	U	1	3.0	0.004	3.4	LOS A	0.0	0.4	0.33	0.15	35.2	
1	L2	1	3.0	0.004	3.4	LOS A	0.0	0.4	0.33	0.15	34.3	
6	T1	1	3.0	0.004	3.4	LOS A	0.0	0.4	0.33	0.15	34.3	
16	R2	1	3.0	0.004	3.4	LOS A	0.0	0.4	0.33	0.15	33.3	
Approach		4	3.0	0.004	3.4	LOS A	0.0	0.4	0.33	0.15	34.3	
North: Wilson Gulch Dr												
7u	U	127	3.0	0.131	3.8	LOS A	0.6	15.6	0.09	0.02	33.7	
7	L2	1	3.0	0.131	3.8	LOS A	0.6	15.6	0.09	0.02	33.0	
4	T1	43	3.0	0.131	3.8	LOS A	0.6	15.6	0.09	0.02	32.9	
14	R2	1	3.0	0.131	3.8	LOS A	0.6	15.6	0.09	0.02	32.1	
Approach		173	3.0	0.131	3.8	LOS A	0.6	15.6	0.09	0.02	33.5	
West: US 160 EB Off Ramp												
5u	U	12	3.0	0.069	3.6	LOS A	0.3	6.8	0.29	0.16	33.8	
5	L2	67	3.0	0.069	3.6	LOS A	0.3	6.8	0.29	0.16	33.0	
2	T1	1	3.0	0.069	3.6	LOS A	0.3	6.8	0.29	0.16	33.0	
12	R2	11	3.0	0.008	2.8	LOS A	0.0	0.8	0.13	0.04	35.3	
Approach		91	3.0	0.069	3.5	LOS A	0.3	6.8	0.27	0.15	33.4	
All Vehicles		273	3.0	0.131	3.7	LOS A	0.6	15.6	0.16	0.07	33.5	

Site Level of Service (LOS) Method: Delay & v/c (HCM 6). Site LOS Method is specified in the Parameter Settings dialog (Site tab).

Roundabout LOS Method: Same as Sign Control.

Vehicle movement LOS values are based on average delay and v/c ratio (degree of saturation) per movement.

LOS F will result if v/c > 1 irrespective of movement delay value (does not apply for approaches and intersection).

Intersection and Approach LOS values are based on average delay for all movements (v/c not used as specified in HCM 6).

Roundabout Capacity Model: US HCM 6.





























HCM Delay Formula option is used. Control Delay does not include Geometric Delay since Exclude Geometric Delay option applies.

Gap-Acceptance Capacity: Traditional M1.

























HV (%) values are calculated for All Movement Classes of All Heavy Vehicle Model Designation.

HCM 2010 Signalized Intersection Summary  
4: Three Springs Road & US 160

Existing Conditions Winter PM  
01/08/2019

												
Movement	EBL	EBT	EBR	WBL	WBT	WBR	NBL	NBT	NBR	SBL	SBT	SBR
Lane Configurations	 	 			 					 		
Traffic Volume (veh/h)	170	1199	6	16	603	57	11	9	16	173	7	360
Future Volume (veh/h)	170	1199	6	16	603	57	11	9	16	173	7	360
Number	1	6	16	5	2	12	3	8	18	7	4	14
Initial Q (Qb), veh	0	0	0	0	0	0	0	0	0	0	0	0
Ped-Bike Adj(A_pbT)	1.00		1.00	1.00		1.00	1.00		1.00	1.00		1.00
Parking Bus, Adj	1.00	1.00	1.00	1.00	1.00	1.00	1.00	1.00	1.00	1.00	1.00	1.00
Adj Sat Flow, veh/h/ln	1740	1707	1740	1740	1707	1740	1740	1740	1740	1740	1740	1740
Adj Flow Rate, veh/h	200	1411	0	17	635	0	20	16	0	211	9	0
Adj No. of Lanes	2	2	1	1	2	1	1	1	1	2	1	1
Peak Hour Factor	0.85	0.85	0.85	0.95	0.95	0.95	0.56	0.56	0.56	0.82	0.82	0.82
Percent Heavy Veh, %	2	4	2	2	4	2	2	2	2	2	2	2
Cap, veh/h	442	2283	1012	27	1891	833	166	67	42	363	87	59
Arrive On Green	0.14	0.70	0.00	0.02	0.58	0.00	0.06	0.04	0.00	0.07	0.05	0.00
Sat Flow, veh/h	3215	3243	1479	1657	3243	1479	1657	1740	1479	3215	1740	1479
Grp Volume(v), veh/h	200	1411	0	17	635	0	20	16	0	211	9	0
Grp Sat Flow(s),veh/h/ln	1608	1621	1479	1657	1621	1479	1657	1740	1479	1608	1740	1479
Q Serve(g_s), s	5.7	22.8	0.0	1.0	10.2	0.0	0.0	0.9	0.0	6.5	0.5	0.0
Cycle Q Clear(g_c), s	5.7	22.8	0.0	1.0	10.2	0.0	0.0	0.9	0.0	6.5	0.5	0.0
Prop In Lane	1.00		1.00	1.00		1.00	1.00		1.00	1.00		1.00
Lane Grp Cap(c), veh/h	442	2283	1012	27	1891	833	166	67	42	363	87	59
V/C Ratio(X)	0.45	0.62	0.00	0.63	0.34	0.00	0.12	0.24	0.00	0.58	0.10	0.00
Avail Cap(c_a), veh/h	442	2283	1012	96	1891	833	185	118	86	363	118	86
HCM Platoon Ratio	1.00	1.00	1.00	1.00	1.00	1.00	1.00	1.00	1.00	1.00	1.00	1.00
Upstream Filter(I)	1.00	1.00	0.00	1.00	1.00	0.00	1.00	1.00	0.00	1.00	1.00	0.00
Uniform Delay (d), s/veh	39.7	7.8	0.0	48.9	10.8	0.0	44.5	46.6	0.0	46.4	45.4	0.0
Incr Delay (d2), s/veh	0.4	1.3	0.0	13.6	0.5	0.0	0.2	1.1	0.0	1.9	0.3	0.0
Initial Q Delay(d3),s/veh	0.0	0.0	0.0	0.0	0.0	0.0	0.0	0.0	0.0	0.0	0.0	0.0
%ile BackOfQ(50%),veh/ln	2.6	10.4	0.0	0.6	4.6	0.0	0.5	0.5	0.0	3.0	0.2	0.0
LnGrp Delay(d),s/veh	40.1	9.0	0.0	62.5	11.3	0.0	44.7	47.8	0.0	48.3	45.7	0.0
LnGrp LOS	D	A		E	B		D	D		D	D	
Approach Vol, veh/h		1611			652			36			220	
Approach Delay, s/veh		12.9			12.6			46.1			48.2	
Approach LOS		B			B			D			D	
Timer	1	2	3	4	5	6	7	8				
Assigned Phs	1	2	3	4	5	6	7	8				
Phs Duration (G+Y+Rc), s	18.9	62.0	9.9	9.2	6.8	74.1	11.0	8.1				
Change Period (Y+Rc), s	5.7	5.7	* 5.2	* 5.2	5.7	5.7	* 5.2	* 5.2				
Max Green Setting (Gmax), s	10.3	56.3	* 5.8	* 5.8	5.3	61.3	* 5.8	* 5.8				
Max Q Clear Time (g_c+I1), s	7.7	12.2	2.0	2.5	3.0	24.8	8.5	2.9				
Green Ext Time (p_c), s	0.2	3.0	0.0	0.0	0.0	9.6	0.0	0.0				
<b>Intersection Summary</b>												
HCM 2010 Ctrl Delay			16.4									
HCM 2010 LOS			B									
<b>Notes</b>												



												
Movement	EBL	EBT	EBR	WBL	WBT	WBR	NBL	NBT	NBR	SBL	SBT	SBR
Lane Configurations												
Traffic Volume (veh/h)	192	788	423	36	272	30	287	60	55	45	46	71
Future Volume (veh/h)	192	788	423	36	272	30	287	60	55	45	46	71
Number	1	6	16	5	2	12	3	8	18	7	4	14
Initial Q (Qb), veh	0	0	0	0	0	0	0	0	0	0	0	0
Ped-Bike Adj(A_pbT)	1.00		1.00	1.00		1.00	1.00		1.00	1.00		1.00
Parking Bus, Adj	1.00	1.00	1.00	1.00	1.00	1.00	1.00	1.00	1.00	1.00	1.00	1.00
Adj Sat Flow, veh/h/ln	1740	1690	1740	1740	1690	1740	1740	1740	1740	1740	1740	1740
Adj Flow Rate, veh/h	204	838	0	42	320	0	367	0	0	51	52	0
Adj No. of Lanes	1	2	1	1	2	1	2	0	1	1	1	1
Peak Hour Factor	0.94	0.94	0.94	0.85	0.85	0.85	0.90	0.90	0.90	0.88	0.88	0.88
Percent Heavy Veh, %	2	5	2	2	5	2	2	2	2	2	2	2
Cap, veh/h	708	1886	868	60	1748	805	478	0	199	95	100	70
Arrive On Green	0.08	0.59	0.00	0.04	0.54	0.00	0.14	0.00	0.00	0.06	0.06	0.00
Sat Flow, veh/h	1657	3212	1479	1657	3212	1479	3315	0	1479	1657	1740	1479
Grp Volume(v), veh/h	204	838	0	42	320	0	367	0	0	51	52	0
Grp Sat Flow(s),veh/h/ln	1657	1606	1479	1657	1606	1479	1657	0	1479	1657	1740	1479
Q Serve(g_s), s	5.4	14.6	0.0	2.5	5.0	0.0	10.7	0.0	0.0	3.0	2.9	0.0
Cycle Q Clear(g_c), s	5.4	14.6	0.0	2.5	5.0	0.0	10.7	0.0	0.0	3.0	2.9	0.0
Prop In Lane	1.00		1.00	1.00		1.00	1.00		1.00	1.00		1.00
Lane Grp Cap(c), veh/h	708	1886	868	60	1748	805	478	0	199	95	100	70
V/C Ratio(X)	0.29	0.44	0.00	0.70	0.18	0.00	0.77	0.00	0.00	0.54	0.52	0.00
Avail Cap(c_a), veh/h	718	1886	868	141	1748	805	762	0	325	149	157	118
HCM Platoon Ratio	1.00	1.00	1.00	1.00	1.00	1.00	1.00	1.00	1.00	1.00	1.00	1.00
Upstream Filter(I)	1.00	1.00	0.00	1.00	1.00	0.00	1.00	0.00	0.00	1.00	1.00	0.00
Uniform Delay (d), s/veh	8.6	11.5	0.0	47.7	11.5	0.0	41.2	0.0	0.0	45.8	45.8	0.0
Incr Delay (d2), s/veh	0.1	0.8	0.0	8.8	0.2	0.0	1.6	0.0	0.0	2.8	2.5	0.0
Initial Q Delay(d3),s/veh	0.0	0.0	0.0	0.0	0.0	0.0	0.0	0.0	0.0	0.0	0.0	0.0
%ile BackOfQ(50%),veh/ln	2.5	6.6	0.0	1.3	2.3	0.0	5.0	0.0	0.0	1.4	1.5	0.0
LnGrp Delay(d),s/veh	8.8	12.3	0.0	56.4	11.8	0.0	42.8	0.0	0.0	48.7	48.3	0.0
LnGrp LOS	A	B		E	B		D			D	D	
Approach Vol, veh/h		1042			362			367			103	
Approach Delay, s/veh		11.6			16.9			42.8			48.5	
Approach LOS		B			B			D			D	
Timer	1	2	3	4	5	6	7	8				
Assigned Phs	1	2		4	5	6		8				
Phs Duration (G+Y+Rc), s	13.4	58.4		9.7	9.1	62.7		18.4				
Change Period (Y+Rc), s	6.0	6.0		5.0	6.0	6.0		5.0				
Max Green Setting (Gmax), s	8.0	40.0		8.0	8.0	40.0		22.0				
Max Q Clear Time (g_c+1), s	7.4	7.0		5.0	4.5	16.6		12.7				
Green Ext Time (p_c), s	0.0	22.5		0.0	0.0	17.4		0.8				
<b>Intersection Summary</b>												
HCM 2010 Ctrl Delay			20.8									
HCM 2010 LOS			C									
<b>Notes</b>												

Intersection												
Int Delay, s/veh	1.7											
Movement	EBL	EBT	EBR	WBL	WBT	WBR	NBL	NBT	NBR	SBL	SBT	SBR
Lane Configurations		↑	↗		↕		↖	↑	↗	↖	↑	↗
Traffic Vol, veh/h	18	2	37	4	4	24	17	288	4	33	354	31
Future Vol, veh/h	18	2	37	4	4	24	17	288	4	33	354	31
Conflicting Peds, #/hr	0	0	0	0	0	0	0	0	0	0	0	0
Sign Control	Stop	Stop	Stop	Stop	Stop	Stop	Free	Free	Free	Free	Free	Free
RT Channelized	-	-	Stop	-	-	None	-	-	None	-	-	None
Storage Length	-	-	170	-	-	-	140	-	280	540	-	430
Veh in Median Storage, #	-	0	-	-	0	-	-	0	-	-	0	-
Grade, %	-	0	-	-	0	-	-	0	-	-	0	-
Peak Hour Factor	94	94	94	94	94	94	94	94	94	94	94	94
Heavy Vehicles, %	2	2	2	2	2	2	2	2	2	2	2	2
Mvmt Flow	19	2	39	4	4	26	18	306	4	35	377	33

Major/Minor	Minor2		Minor1		Major1		Major2					
Conflicting Flow All	804	790	377	791	790	306	377	0	0	306	0	0
Stage 1	447	447	-	343	343	-	-	-	-	-	-	-
Stage 2	357	343	-	448	447	-	-	-	-	-	-	-
Critical Hdwy	7.12	6.52	6.22	7.12	6.52	6.22	4.12	-	-	4.12	-	-
Critical Hdwy Stg 1	6.12	5.52	-	6.12	5.52	-	-	-	-	-	-	-
Critical Hdwy Stg 2	6.12	5.52	-	6.12	5.52	-	-	-	-	-	-	-
Follow-up Hdwy	3.518	4.018	3.318	3.518	4.018	3.318	2.218	-	-	2.218	-	-
Pot Cap-1 Maneuver	301	322	670	307	322	734	1181	-	-	1255	-	-
Stage 1	591	573	-	672	637	-	-	-	-	-	-	-
Stage 2	661	637	-	590	573	-	-	-	-	-	-	-
Platoon blocked, %								-	-	-	-	-
Mov Cap-1 Maneuver	278	308	670	278	308	734	1181	-	-	1255	-	-
Mov Cap-2 Maneuver	278	308	-	278	308	-	-	-	-	-	-	-
Stage 1	582	557	-	662	627	-	-	-	-	-	-	-
Stage 2	624	627	-	538	557	-	-	-	-	-	-	-

Approach	EB	WB	NB	SB
HCM Control Delay, s	11	12.2	0.4	0.6
HCM LOS	B	B		

Minor Lane/Major Mvmt	NBL	NBT	NBR	EBLn1	EBLn2	WBLn1	SBL	SBT	SBR
Capacity (veh/h)	1181	-	-	308	670	533	1255	-	-
HCM Lane V/C Ratio	0.015	-	-	0.007	0.059	0.064	0.028	-	-
HCM Control Delay (s)	8.1	-	-	16.8	10.7	12.2	8	-	-
HCM Lane LOS	A	-	-	C	B	B	A	-	-
HCM 95th %tile Q(veh)	0	-	-	0	0.2	0.2	0.1	-	-

# MOVEMENT SUMMARY

 Site: 101 [Wilson Gulch Dr & US 160 Ramps AM - Redistributed]

Roundabout

Movement Performance - Vehicles											
Mov ID	OD Mov	Demand Total veh/h	Flows HV %	Deg. Satn v/c	Average Delay sec	Level of Service	95% Back of Queue Vehicles veh	Distance ft	Prop. Queued	Effective Stop Rate per veh	Average Speed mph
East: US 160 WB Ramps											
1u	U	1	3.0	0.005	3.8	LOS A	0.0	0.5	0.42	0.23	35.7
6	T1	1	3.0	0.005	3.8	LOS A	0.0	0.5	0.42	0.23	34.7
16	R2	2	3.0	0.005	3.8	LOS A	0.0	0.5	0.42	0.23	33.7
Approach		4	3.0	0.005	3.8	LOS A	0.0	0.5	0.42	0.23	34.5
North: Wilson Gulch Dr											
7u	U	91	3.0	0.070	3.3	LOS A	0.3	7.9	0.06	0.01	33.1
7	L2	1	3.0	0.070	3.3	LOS A	0.3	7.9	0.06	0.01	32.4
14	R2	1	3.0	0.070	3.3	LOS A	0.3	7.9	0.06	0.01	31.5
Approach		93	3.0	0.070	3.3	LOS A	0.3	7.9	0.06	0.01	33.1
West: US 160 EB Off Ramp											
5u	U	7	3.0	0.199	4.7	LOS A	1.0	24.8	0.26	0.13	33.4
5	L2	234	3.0	0.199	4.7	LOS A	1.0	24.8	0.26	0.13	32.6
2	T1	1	3.0	0.199	4.7	LOS A	1.0	24.8	0.26	0.13	32.6
Approach		241	3.0	0.199	4.7	LOS A	1.0	24.8	0.26	0.13	32.7
All Vehicles		339	3.0	0.199	4.3	LOS A	1.0	24.8	0.21	0.10	32.8

Site Level of Service (LOS) Method: Delay & v/c (HCM 6). Site LOS Method is specified in the Parameter Settings dialog (Site tab).

Roundabout LOS Method: Same as Sign Control.

Vehicle movement LOS values are based on average delay and v/c ratio (degree of saturation) per movement.

LOS F will result if v/c > 1 irrespective of movement delay value (does not apply for approaches and intersection).

Intersection and Approach LOS values are based on average delay for all movements (v/c not used as specified in HCM 6).

Roundabout Capacity Model: US HCM 6.

HCM Delay Formula option is used. Control Delay does not include Geometric Delay since Exclude Geometric Delay option applies.

Gap-Acceptance Capacity: Traditional M1.

HV (%) values are calculated for All Movement Classes of All Heavy Vehicle Model Designation.

























**SIDRA INTERSECTION 7.0 | Copyright © 2000-2017 Akcelik and Associates Pty Ltd | sidrasolutions.com**

Organisation: FEHR AND PEERS | Processed: Thursday, November 15, 2018 12:31:38 PM

Project: N:\Projects\2017 Projects\0569.03 - 150 and 550 MOT\Analysis\Sidra\Roundabout.sip7

HCM 2010 Signalized Intersection Summary  
4: Three Springs Road & US 160

Detour - Existing Sumemr AM  
01/08/2019

												
Movement	EBL	EBT	EBR	WBL	WBT	WBR	NBL	NBT	NBR	SBL	SBT	SBR
Lane Configurations												
Traffic Volume (veh/h)	420	499	2	28	1520	268	30	9	12	87	3	157
Future Volume (veh/h)	420	499	2	28	1520	268	30	9	12	87	3	157
Number	1	6	16	5	2	12	3	8	18	7	4	14
Initial Q (Qb), veh	0	0	0	0	0	0	0	0	0	0	0	0
Ped-Bike Adj(A_pbT)	1.00		1.00	1.00		1.00	1.00		1.00	1.00		1.00
Parking Bus, Adj	1.00	1.00	1.00	1.00	1.00	1.00	1.00	1.00	1.00	1.00	1.00	1.00
Adj Sat Flow, veh/h/ln	1740	1707	1740	1740	1707	1740	1740	1740	1740	1740	1740	1740
Adj Flow Rate, veh/h	488	580	0	36	1974	0	43	13	0	113	4	0
Adj No. of Lanes	2	2	1	1	2	1	1	1	1	2	1	1
Peak Hour Factor	0.86	0.86	0.86	0.77	0.77	0.77	0.69	0.69	0.69	0.77	0.77	0.77
Percent Heavy Veh, %	2	4	2	2	4	2	2	2	2	2	2	2
Cap, veh/h	556	2317	1027	52	1858	818	182	74	48	364	85	58
Arrive On Green	0.17	0.71	0.00	0.03	0.57	0.00	0.03	0.04	0.00	0.04	0.05	0.00
Sat Flow, veh/h	3215	3243	1479	1657	3243	1479	1657	1740	1479	3215	1740	1479
Grp Volume(v), veh/h	488	580	0	36	1974	0	43	13	0	113	4	0
Grp Sat Flow(s),veh/h/ln	1608	1621	1479	1657	1621	1479	1657	1740	1479	1608	1740	1479
Q Serve(g_s), s	14.8	6.2	0.0	2.2	57.3	0.0	0.0	0.7	0.0	0.0	0.2	0.0
Cycle Q Clear(g_c), s	14.8	6.2	0.0	2.2	57.3	0.0	0.0	0.7	0.0	0.0	0.2	0.0
Prop In Lane	1.00		1.00	1.00		1.00	1.00		1.00	1.00		1.00
Lane Grp Cap(c), veh/h	556	2317	1027	52	1858	818	182	74	48	364	85	58
V/C Ratio(X)	0.88	0.25	0.00	0.69	1.06	0.00	0.24	0.18	0.00	0.31	0.05	0.00
Avail Cap(c_a), veh/h	556	2317	1027	96	1858	818	241	118	86	458	118	86
HCM Platoon Ratio	1.00	1.00	1.00	1.00	1.00	1.00	1.00	1.00	1.00	1.00	1.00	1.00
Upstream Filter(I)	1.00	1.00	0.00	1.00	1.00	0.00	1.00	1.00	0.00	1.00	1.00	0.00
Uniform Delay (d), s/veh	40.3	5.0	0.0	48.0	21.4	0.0	44.4	46.2	0.0	44.7	45.3	0.0
Incr Delay (d2), s/veh	14.5	0.3	0.0	9.8	39.7	0.0	0.4	0.7	0.0	0.3	0.1	0.0
Initial Q Delay(d3),s/veh	0.0	0.0	0.0	0.0	0.0	0.0	0.0	0.0	0.0	0.0	0.0	0.0
%ile BackOfQ(50%),veh/ln	7.7	2.8	0.0	1.1	35.5	0.0	1.2	0.4	0.0	1.5	0.1	0.0
LnGrp Delay(d),s/veh	54.9	5.2	0.0	57.7	61.1	0.0	44.8	46.9	0.0	45.0	45.5	0.0
LnGrp LOS	D	A		E	F		D	D		D	D	
Approach Vol, veh/h		1068			2010			56			117	
Approach Delay, s/veh		27.9			61.0			45.3			45.0	
Approach LOS		C			E			D			D	
Timer	1	2	3	4	5	6	7	8				
Assigned Phs	1	2	3	4	5	6	7	8				
Phs Duration (G+Y+Rc), s	22.5	61.0	7.4	9.1	8.3	75.2	8.1	8.4				
Change Period (Y+Rc), s	5.7	5.7	* 5.2	* 5.2	5.7	5.7	* 5.2	* 5.2				
Max Green Setting (Gmax), s	11.3	55.3	* 5.8	* 5.8	5.3	61.3	* 5.8	* 5.8				
Max Q Clear Time (g_c+I1), s	16.8	59.3	2.0	2.2	4.2	8.2	2.0	2.7				
Green Ext Time (p_c), s	0.0	0.0	0.1	0.0	0.0	4.2	0.1	0.0				
<b>Intersection Summary</b>												
HCM 2010 Ctrl Delay			49.3									
HCM 2010 LOS			D									
<b>Notes</b>												

# MOVEMENT SUMMARY

 Site: 101 [Wilson Gulch Dr & US 160 Ramps PM -Redistributed]

Roundabout

Movement Performance - Vehicles											
Mov ID	OD Mov	Demand Total veh/h	Flows HV %	Deg. Satn v/c	Average Delay sec	Level of Service	95% Back of Queue Vehicles veh	Distance ft	Prop. Queued	Effective Stop Rate per veh	Average Speed mph
East: US 160 WB Ramps											
1u	U	1	3.0	0.003	3.7	LOS A	0.0	0.3	0.40	0.21	35.4
6	T1	1	3.0	0.003	3.7	LOS A	0.0	0.3	0.40	0.21	34.5
16	R2	1	3.0	0.003	3.7	LOS A	0.0	0.3	0.40	0.21	33.5
Approach		3	3.0	0.003	3.7	LOS A	0.0	0.3	0.40	0.21	34.4
North: Wilson Gulch Dr											
7u	U	197	3.0	0.151	4.0	LOS A	0.7	18.4	0.09	0.02	32.7
7	L2	1	3.0	0.151	4.0	LOS A	0.7	18.4	0.09	0.02	32.1
14	R2	1	3.0	0.151	4.0	LOS A	0.7	18.4	0.09	0.02	31.2
Approach		199	3.0	0.151	4.0	LOS A	0.7	18.4	0.09	0.02	32.7
West: US 160 EB Off Ramp											
5u	U	14	3.0	0.097	4.2	LOS A	0.4	10.6	0.35	0.22	33.5
5	L2	90	3.0	0.097	4.2	LOS A	0.4	10.6	0.35	0.22	32.8
2	T1	1	3.0	0.097	4.2	LOS A	0.4	10.6	0.35	0.22	32.7
Approach		105	3.0	0.097	4.2	LOS A	0.4	10.6	0.35	0.22	32.9
All Vehicles		308	3.0	0.151	4.0	LOS A	0.7	18.4	0.18	0.09	32.8

Site Level of Service (LOS) Method: Delay & v/c (HCM 6). Site LOS Method is specified in the Parameter Settings dialog (Site tab).

Roundabout LOS Method: Same as Sign Control.

Vehicle movement LOS values are based on average delay and v/c ratio (degree of saturation) per movement.

LOS F will result if v/c > 1 irrespective of movement delay value (does not apply for approaches and intersection).

Intersection and Approach LOS values are based on average delay for all movements (v/c not used as specified in HCM 6).

Roundabout Capacity Model: US HCM 6.

HCM Delay Formula option is used. Control Delay does not include Geometric Delay since Exclude Geometric Delay option applies.

Gap-Acceptance Capacity: Traditional M1.

HV (%) values are calculated for All Movement Classes of All Heavy Vehicle Model Designation.

























**SIDRA INTERSECTION 7.0 | Copyright © 2000-2017 Akcelik and Associates Pty Ltd | sidrasolutions.com**

Organisation: FEHR AND PEERS | Processed: Thursday, November 15, 2018 12:39:03 PM

Project: N:\Projects\2017 Projects\0569.03 - 150 and 550 MOT\Analysis\Sidra\Roundabout.sip7

HCM 2010 Signalized Intersection Summary  
4: Three Springs Road & US 160

Detour Existing Summer PM  
01/08/2019

												
Movement	EBL	EBT	EBR	WBL	WBT	WBR	NBL	NBT	NBR	SBL	SBT	SBR
Lane Configurations												
Traffic Volume (veh/h)	196	1379	7	18	693	66	13	10	18	246	8	425
Future Volume (veh/h)	196	1379	7	18	693	66	13	10	18	246	8	425
Number	1	6	16	5	2	12	3	8	18	7	4	14
Initial Q (Qb), veh	0	0	0	0	0	0	0	0	0	0	0	0
Ped-Bike Adj(A_pbT)	1.00		1.00	1.00		1.00	1.00		1.00	1.00		1.00
Parking Bus, Adj	1.00	1.00	1.00	1.00	1.00	1.00	1.00	1.00	1.00	1.00	1.00	1.00
Adj Sat Flow, veh/h/ln	1740	1707	1740	1740	1707	1740	1740	1740	1740	1740	1740	1740
Adj Flow Rate, veh/h	231	1622	0	19	729	0	23	18	0	300	10	0
Adj No. of Lanes	2	2	1	1	2	1	1	1	1	2	1	1
Peak Hour Factor	0.85	0.85	0.85	0.95	0.95	0.95	0.56	0.56	0.56	0.82	0.82	0.82
Percent Heavy Veh, %	2	4	2	2	4	2	2	2	2	2	2	2
Cap, veh/h	436	2273	1007	30	1891	833	169	70	45	363	87	59
Arrive On Green	0.14	0.70	0.00	0.02	0.58	0.00	0.06	0.04	0.00	0.07	0.05	0.00
Sat Flow, veh/h	3215	3243	1479	1657	3243	1479	1657	1740	1479	3215	1740	1479
Grp Volume(v), veh/h	231	1622	0	19	729	0	23	18	0	300	10	0
Grp Sat Flow(s),veh/h/ln	1608	1621	1479	1657	1621	1479	1657	1740	1479	1608	1740	1479
Q Serve(g_s), s	6.7	29.9	0.0	1.1	12.1	0.0	0.0	1.0	0.0	6.8	0.5	0.0
Cycle Q Clear(g_c), s	6.7	29.9	0.0	1.1	12.1	0.0	0.0	1.0	0.0	6.8	0.5	0.0
Prop In Lane	1.00		1.00	1.00		1.00	1.00		1.00	1.00		1.00
Lane Grp Cap(c), veh/h	436	2273	1007	30	1891	833	169	70	45	363	87	59
V/C Ratio(X)	0.53	0.71	0.00	0.64	0.39	0.00	0.14	0.26	0.00	0.83	0.11	0.00
Avail Cap(c_a), veh/h	436	2273	1007	96	1891	833	185	118	86	363	118	86
HCM Platoon Ratio	1.00	1.00	1.00	1.00	1.00	1.00	1.00	1.00	1.00	1.00	1.00	1.00
Upstream Filter(I)	1.00	1.00	0.00	1.00	1.00	0.00	1.00	1.00	0.00	1.00	1.00	0.00
Uniform Delay (d), s/veh	40.2	9.0	0.0	48.8	11.2	0.0	44.3	46.5	0.0	47.4	45.4	0.0
Incr Delay (d2), s/veh	0.8	1.9	0.0	13.2	0.6	0.0	0.2	1.2	0.0	14.1	0.4	0.0
Initial Q Delay(d3),s/veh	0.0	0.0	0.0	0.0	0.0	0.0	0.0	0.0	0.0	0.0	0.0	0.0
%ile BackOfQ(50%),veh/ln	3.0	13.9	0.0	0.6	5.5	0.0	0.6	0.5	0.0	1.8	0.3	0.0
LnGrp Delay(d),s/veh	41.1	10.9	0.0	62.0	11.8	0.0	44.6	47.7	0.0	61.5	45.7	0.0
LnGrp LOS	D	B		E	B		D	D		E	D	
Approach Vol, veh/h		1853			748			41			310	
Approach Delay, s/veh		14.7			13.1			45.9			61.0	
Approach LOS		B			B			D			E	
Timer	1	2	3	4	5	6	7	8				
Assigned Phs	1	2	3	4	5	6	7	8				
Phs Duration (G+Y+Rc), s	18.8	62.0	10.0	9.2	7.0	73.8	11.0	8.2				
Change Period (Y+Rc), s	5.7	5.7	* 5.2	* 5.2	5.7	5.7	* 5.2	* 5.2				
Max Green Setting (Gmax), s	10.3	56.3	* 5.8	* 5.8	5.3	61.3	* 5.8	* 5.8				
Max Q Clear Time (g_c+I1), s	8.7	14.1	2.0	2.5	3.1	31.9	8.8	3.0				
Green Ext Time (p_c), s	0.1	3.5	0.0	0.0	0.0	11.4	0.0	0.0				
<b>Intersection Summary</b>												
HCM 2010 Ctrl Delay			19.6									
HCM 2010 LOS			B									
<b>Notes</b>												

# MOVEMENT SUMMARY

 Site: 101 [Wilson Gulch Dr & US 160 Ramps AM - Redistributed]

Roundabout

Movement Performance - Vehicles												
Mov ID	OD Mov	Demand Total veh/h	Flows HV %	Deg. Satn v/c	Average Delay sec	Level of Service	95% Back of Queue Vehicles veh	Distance ft	Prop. Queued	Effective Stop Rate per veh	Average Speed mph	
East: US 160 WB Ramps												
1u	U	1	3.0	0.004	3.7	LOS A	0.0	0.4	0.39	0.20	35.8	
6	T1	1	3.0	0.004	3.7	LOS A	0.0	0.4	0.39	0.20	34.8	
16	R2	2	3.0	0.004	3.7	LOS A	0.0	0.4	0.39	0.20	33.8	
Approach		4	3.0	0.004	3.7	LOS A	0.0	0.4	0.39	0.20	34.5	
North: Wilson Gulch Dr												
7u	U	79	3.0	0.061	3.2	LOS A	0.3	6.8	0.05	0.01	33.1	
7	L2	1	3.0	0.061	3.2	LOS A	0.3	6.8	0.05	0.01	32.4	
14	R2	1	3.0	0.061	3.2	LOS A	0.3	6.8	0.05	0.01	31.6	
Approach		82	3.0	0.061	3.2	LOS A	0.3	6.8	0.05	0.01	33.1	
West: US 160 EB Off Ramp												
5u	U	5	3.0	0.171	4.4	LOS A	0.8	20.7	0.23	0.11	33.5	
5	L2	203	3.0	0.171	4.4	LOS A	0.8	20.7	0.23	0.11	32.8	
2	T1	1	3.0	0.171	4.4	LOS A	0.8	20.7	0.23	0.11	32.7	
Approach		210	3.0	0.171	4.4	LOS A	0.8	20.7	0.23	0.11	32.8	
All Vehicles		296	3.0	0.171	4.0	LOS A	0.8	20.7	0.19	0.08	32.9	

Site Level of Service (LOS) Method: Delay & v/c (HCM 6). Site LOS Method is specified in the Parameter Settings dialog (Site tab).

Roundabout LOS Method: Same as Sign Control.

Vehicle movement LOS values are based on average delay and v/c ratio (degree of saturation) per movement.

LOS F will result if v/c > 1 irrespective of movement delay value (does not apply for approaches and intersection).

Intersection and Approach LOS values are based on average delay for all movements (v/c not used as specified in HCM 6).

Roundabout Capacity Model: US HCM 6.

HCM Delay Formula option is used. Control Delay does not include Geometric Delay since Exclude Geometric Delay option applies.

Gap-Acceptance Capacity: Traditional M1.

HV (%) values are calculated for All Movement Classes of All Heavy Vehicle Model Designation.

























**SIDRA INTERSECTION 7.0 | Copyright © 2000-2017 Akcelik and Associates Pty Ltd | sidrasolutions.com**

Organisation: FEHR AND PEERS | Processed: Tuesday, January 8, 2019 2:27:47 PM

Project: N:\Projects\2017 Projects\0569.03 - 150 and 550 MOT\Analysis\Sidra\Roundabout - Winter.sip7

HCM 2010 Signalized Intersection Summary  
 4: Three Springs Road & US 160

Detour - Existing Winter AM  
 01/08/2019

												
Movement	EBL	EBT	EBR	WBL	WBT	WBR	NBL	NBT	NBR	SBL	SBT	SBR
Lane Configurations												
Traffic Volume (veh/h)	364	434	2	24	1321	233	26	8	10	75	3	136
Future Volume (veh/h)	364	434	2	24	1321	233	26	8	10	75	3	136
Number	1	6	16	5	2	12	3	8	18	7	4	14
Initial Q (Qb), veh	0	0	0	0	0	0	0	0	0	0	0	0
Ped-Bike Adj(A_pbT)	1.00		1.00	1.00		1.00	1.00		1.00	1.00		1.00
Parking Bus, Adj	1.00	1.00	1.00	1.00	1.00	1.00	1.00	1.00	1.00	1.00	1.00	1.00
Adj Sat Flow, veh/h/ln	1740	1707	1740	1740	1707	1740	1740	1740	1740	1740	1740	1740
Adj Flow Rate, veh/h	423	505	0	31	1716	0	38	12	0	97	4	0
Adj No. of Lanes	2	2	1	1	2	1	1	1	1	2	1	1
Peak Hour Factor	0.86	0.86	0.86	0.77	0.77	0.77	0.69	0.69	0.69	0.77	0.77	0.77
Percent Heavy Veh, %	2	4	2	2	4	2	2	2	2	2	2	2
Cap, veh/h	563	2337	1036	45	1858	818	178	71	46	359	84	57
Arrive On Green	0.17	0.72	0.00	0.03	0.57	0.00	0.03	0.04	0.00	0.04	0.05	0.00
Sat Flow, veh/h	3215	3243	1479	1657	3243	1479	1657	1740	1479	3215	1740	1479
Grp Volume(v), veh/h	423	505	0	31	1716	0	38	12	0	97	4	0
Grp Sat Flow(s),veh/h/ln	1608	1621	1479	1657	1621	1479	1657	1740	1479	1608	1740	1479
Q Serve(g_s), s	12.5	5.2	0.0	1.9	48.0	0.0	0.0	0.7	0.0	0.0	0.2	0.0
Cycle Q Clear(g_c), s	12.5	5.2	0.0	1.9	48.0	0.0	0.0	0.7	0.0	0.0	0.2	0.0
Prop In Lane	1.00		1.00	1.00		1.00	1.00		1.00	1.00		1.00
Lane Grp Cap(c), veh/h	563	2337	1036	45	1858	818	178	71	46	359	84	57
V/C Ratio(X)	0.75	0.22	0.00	0.69	0.92	0.00	0.21	0.17	0.00	0.27	0.05	0.00
Avail Cap(c_a), veh/h	563	2337	1036	96	1858	818	239	118	86	456	118	86
HCM Platoon Ratio	1.00	1.00	1.00	1.00	1.00	1.00	1.00	1.00	1.00	1.00	1.00	1.00
Upstream Filter(I)	1.00	1.00	0.00	1.00	1.00	0.00	1.00	1.00	0.00	1.00	1.00	0.00
Uniform Delay (d), s/veh	39.2	4.6	0.0	48.2	19.4	0.0	44.5	46.3	0.0	44.6	45.4	0.0
Incr Delay (d2), s/veh	5.3	0.2	0.0	10.7	9.2	0.0	0.4	0.7	0.0	0.2	0.1	0.0
Initial Q Delay(d3),s/veh	0.0	0.0	0.0	0.0	0.0	0.0	0.0	0.0	0.0	0.0	0.0	0.0
%ile BackOfQ(50%),veh/ln	5.9	2.3	0.0	1.0	23.6	0.0	1.0	0.3	0.0	1.3	0.1	0.0
LnGrp Delay(d),s/veh	44.5	4.8	0.0	58.9	28.6	0.0	44.8	47.0	0.0	44.9	45.5	0.0
LnGrp LOS	D	A		E	C		D	D		D	D	
Approach Vol, veh/h		928			1747			50			101	
Approach Delay, s/veh		22.9			29.1			45.4			44.9	
Approach LOS		C			C			D			D	
Timer	1	2	3	4	5	6	7	8				
Assigned Phs	1	2	3	4	5	6	7	8				
Phs Duration (G+Y+Rc), s	22.7	61.0	7.3	9.0	7.9	75.8	8.0	8.3				
Change Period (Y+Rc), s	5.7	5.7	* 5.2	* 5.2	5.7	5.7	* 5.2	* 5.2				
Max Green Setting (Gmax), s	11.3	55.3	* 5.8	* 5.8	5.3	61.3	* 5.8	* 5.8				
Max Q Clear Time (g_c+1), s	14.5	50.0	2.0	2.2	3.9	7.2	2.0	2.7				
Green Ext Time (p_c), s	0.0	3.8	0.1	0.0	0.0	3.5	0.1	0.0				
<b>Intersection Summary</b>												
HCM 2010 Ctrl Delay				27.9								
HCM 2010 LOS				C								
<b>Notes</b>												



# MOVEMENT SUMMARY

 Site: 101 [Wilson Gulch Dr & US 160 Ramps PM -Redistributed]

Roundabout

Movement Performance - Vehicles											
Mov ID	OD Mov	Demand Total veh/h	Flows HV %	Deg. Satn v/c	Average Delay sec	Level of Service	95% Back of Queue Vehicles veh	Distance ft	Prop. Queued	Effective Stop Rate per veh	Average Speed mph
East: US 160 WB Ramps											
1u	U	1	3.0	0.003	3.6	LOS A	0.0	0.3	0.37	0.18	35.5
6	T1	1	3.0	0.003	3.6	LOS A	0.0	0.3	0.37	0.18	34.6
16	R2	1	3.0	0.003	3.6	LOS A	0.0	0.3	0.37	0.18	33.6
Approach		3	3.0	0.003	3.6	LOS A	0.0	0.3	0.37	0.18	34.5
North: Wilson Gulch Dr											
7u	U	171	3.0	0.131	3.8	LOS A	0.6	15.6	0.08	0.02	32.8
7	L2	1	3.0	0.131	3.8	LOS A	0.6	15.6	0.08	0.02	32.2
14	R2	1	3.0	0.131	3.8	LOS A	0.6	15.6	0.08	0.02	31.3
Approach		173	3.0	0.131	3.8	LOS A	0.6	15.6	0.08	0.02	32.8
West: US 160 EB Off Ramp											
5u	U	12	3.0	0.082	3.9	LOS A	0.3	8.9	0.32	0.19	33.6
5	L2	78	3.0	0.082	3.9	LOS A	0.3	8.9	0.32	0.19	32.9
2	T1	1	3.0	0.082	3.9	LOS A	0.3	8.9	0.32	0.19	32.9
Approach		91	3.0	0.082	3.9	LOS A	0.3	8.9	0.32	0.19	33.0
All Vehicles		267	3.0	0.131	3.8	LOS A	0.6	15.6	0.17	0.08	32.9

Site Level of Service (LOS) Method: Delay & v/c (HCM 6). Site LOS Method is specified in the Parameter Settings dialog (Site tab).

Roundabout LOS Method: Same as Sign Control.

Vehicle movement LOS values are based on average delay and v/c ratio (degree of saturation) per movement.

LOS F will result if v/c > 1 irrespective of movement delay value (does not apply for approaches and intersection).

Intersection and Approach LOS values are based on average delay for all movements (v/c not used as specified in HCM 6).

Roundabout Capacity Model: US HCM 6.

HCM Delay Formula option is used. Control Delay does not include Geometric Delay since Exclude Geometric Delay option applies.

Gap-Acceptance Capacity: Traditional M1.

HV (%) values are calculated for All Movement Classes of All Heavy Vehicle Model Designation.





























**SIDRA INTERSECTION 7.0 | Copyright © 2000-2017 Akcelik and Associates Pty Ltd | sidrasolutions.com**

Organisation: FEHR AND PEERS | Processed: Tuesday, January 8, 2019 2:27:05 PM

Project: N:\Projects\2017 Projects\0569.03 - 150 and 550 MOT\Analysis\Sidra\Roundabout - Winter.sip7

HCM 2010 Signalized Intersection Summary  
4: Three Springs Road & US 160

Detour Existing Winter PM  
01/08/2019

												
Movement	EBL	EBT	EBR	WBL	WBT	WBR	NBL	NBT	NBR	SBL	SBT	SBR
Lane Configurations	 	 			 			 		 		
Traffic Volume (veh/h)	170	1199	6	16	603	57	11	9	16	219	7	372
Future Volume (veh/h)	170	1199	6	16	603	57	11	9	16	219	7	372
Number	1	6	16	5	2	12	3	8	18	7	4	14
Initial Q (Qb), veh	0	0	0	0	0	0	0	0	0	0	0	0
Ped-Bike Adj(A_pbT)	1.00		1.00	1.00		1.00	1.00		1.00	1.00		1.00
Parking Bus, Adj	1.00	1.00	1.00	1.00	1.00	1.00	1.00	1.00	1.00	1.00	1.00	1.00
Adj Sat Flow, veh/h/ln	1740	1707	1740	1740	1707	1740	1740	1740	1740	1740	1740	1740
Adj Flow Rate, veh/h	200	1411	0	17	635	0	20	16	0	267	9	0
Adj No. of Lanes	2	2	1	1	2	1	1	1	1	2	1	1
Peak Hour Factor	0.85	0.85	0.85	0.95	0.95	0.95	0.56	0.56	0.56	0.82	0.82	0.82
Percent Heavy Veh, %	2	4	2	2	4	2	2	2	2	2	2	2
Cap, veh/h	442	2283	1012	27	1891	833	166	67	42	363	87	59
Arrive On Green	0.14	0.70	0.00	0.02	0.58	0.00	0.06	0.04	0.00	0.07	0.05	0.00
Sat Flow, veh/h	3215	3243	1479	1657	3243	1479	1657	1740	1479	3215	1740	1479
Grp Volume(v), veh/h	200	1411	0	17	635	0	20	16	0	267	9	0
Grp Sat Flow(s),veh/h/ln	1608	1621	1479	1657	1621	1479	1657	1740	1479	1608	1740	1479
Q Serve(g_s), s	5.7	22.8	0.0	1.0	10.2	0.0	0.0	0.9	0.0	6.8	0.5	0.0
Cycle Q Clear(g_c), s	5.7	22.8	0.0	1.0	10.2	0.0	0.0	0.9	0.0	6.8	0.5	0.0
Prop In Lane	1.00		1.00	1.00		1.00	1.00		1.00	1.00		1.00
Lane Grp Cap(c), veh/h	442	2283	1012	27	1891	833	166	67	42	363	87	59
V/C Ratio(X)	0.45	0.62	0.00	0.63	0.34	0.00	0.12	0.24	0.00	0.74	0.10	0.00
Avail Cap(c_a), veh/h	442	2283	1012	96	1891	833	185	118	86	363	118	86
HCM Platoon Ratio	1.00	1.00	1.00	1.00	1.00	1.00	1.00	1.00	1.00	1.00	1.00	1.00
Upstream Filter(I)	1.00	1.00	0.00	1.00	1.00	0.00	1.00	1.00	0.00	1.00	1.00	0.00
Uniform Delay (d), s/veh	39.7	7.8	0.0	48.9	10.8	0.0	44.5	46.6	0.0	47.1	45.4	0.0
Incr Delay (d2), s/veh	0.4	1.3	0.0	13.6	0.5	0.0	0.2	1.1	0.0	7.1	0.3	0.0
Initial Q Delay(d3),s/veh	0.0	0.0	0.0	0.0	0.0	0.0	0.0	0.0	0.0	0.0	0.0	0.0
%ile BackOfQ(50%),veh/ln	2.6	10.4	0.0	0.6	4.6	0.0	0.5	0.5	0.0	1.0	0.2	0.0
LnGrp Delay(d),s/veh	40.1	9.0	0.0	62.5	11.3	0.0	44.7	47.8	0.0	54.2	45.7	0.0
LnGrp LOS	D	A		E	B		D	D		D	D	
Approach Vol, veh/h		1611			652			36			276	
Approach Delay, s/veh		12.9			12.6			46.1			53.9	
Approach LOS		B			B			D			D	
Timer	1	2	3	4	5	6	7	8				
Assigned Phs	1	2	3	4	5	6	7	8				
Phs Duration (G+Y+Rc), s	18.9	62.0	9.9	9.2	6.8	74.1	11.0	8.1				
Change Period (Y+Rc), s	5.7	5.7	* 5.2	* 5.2	5.7	5.7	* 5.2	* 5.2				
Max Green Setting (Gmax), s	10.3	56.3	* 5.8	* 5.8	5.3	61.3	* 5.8	* 5.8				
Max Q Clear Time (g_c+1), s	7.7	12.2	2.0	2.5	3.0	24.8	8.8	2.9				
Green Ext Time (p_c), s	0.2	3.0	0.0	0.0	0.0	9.6	0.0	0.0				
<b>Intersection Summary</b>												
HCM 2010 Ctrl Delay			17.7									
HCM 2010 LOS			B									
<b>Notes</b>												

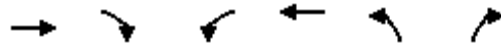

Movement	EBT	EBR	WBL	WBT	NBL	NBR		
Lane Configurations	↑	↗	↖	↑↑	↖	↗		
Traffic Volume (veh/h)	895	190	28	1555	560	102		
Future Volume (veh/h)	895	190	28	1555	560	102		
Number	6	16	5	2	3	18		
Initial Q (Qb), veh	0	0	0	0	0	0		
Ped-Bike Adj(A_pbT)		1.00	1.00		1.00	1.00		
Parking Bus, Adj	1.00	1.00	1.00	1.00	1.00	1.00		
Adj Sat Flow, veh/h/ln	1863	1863	1863	1863	1863	1863		
Adj Flow Rate, veh/h	1091	0	34	1896	683	124		
Adj No. of Lanes	1	1	1	2	1	1		
Peak Hour Factor	0.82	0.82	0.82	0.82	0.82	0.82		
Percent Heavy Veh, %	2	2	2	2	2	2		
Cap, veh/h	602	511	42	0	712	673		
Arrive On Green	0.32	0.00	0.02	0.00	0.40	0.40		
Sat Flow, veh/h	1863	1583	1774	34	1774	1583		
Grp Volume(v), veh/h	1091	0	34	67.2	683	124		
Grp Sat Flow(s),veh/h/ln	1863	1583	1774	E	1774	1583		
Q Serve(g_s), s	32.3	0.0	1.9		37.5	2.5		
Cycle Q Clear(g_c), s	32.3	0.0	1.9		37.5	2.5		
Prop In Lane		1.00	1.00		1.00	1.00		
Lane Grp Cap(c), veh/h	602	511	42		712	673		
V/C Ratio(X)	1.81	0.00	0.80		0.96	0.18		
Avail Cap(c_a), veh/h	602	511	165		745	703		
HCM Platoon Ratio	1.00	1.00	1.00		1.00	1.00		
Upstream Filter(I)	1.00	0.00	1.00		1.00	1.00		
Uniform Delay (d), s/veh	33.9	0.0	48.6		29.2	17.9		
Incr Delay (d2), s/veh	372.5	0.0	18.6		22.8	0.1		
Initial Q Delay(d3),s/veh	0.0	0.0	0.0		0.0	0.0		
%ile BackOfQ(50%),veh/ln	78.8	0.0	1.2		22.7	1.1		
LnGrp Delay(d),s/veh	406.4	0.0	67.2		52.0	18.0		
LnGrp LOS	F		E		D	B		
Approach Vol, veh/h	1091				807			
Approach Delay, s/veh	406.4				46.7			
Approach LOS	F				D			
Timer	1	2	3	4	5	6	7	8
Assigned Phs					5	6		8
Phs Duration (G+Y+Rc), s					8.1	38.0		45.1
Change Period (Y+Rc), s					5.7	5.7		5.0
Max Green Setting (Gmax), s					9.3	32.3		42.0
Max Q Clear Time (g_c+I1), s					3.9	34.3		39.5
Green Ext Time (p_c), s					0.0	0.0		0.6
<b>Intersection Summary</b>								
HCM 2010 Ctrl Delay			250.2					
HCM 2010 LOS			F					

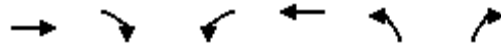

Movement	EBT	EBR	WBL	WBT	NBL	NBR		
Lane Configurations	↑	↗	↖	↑↑	↖	↗		
Traffic Volume (veh/h)	1457	503	85	1203	242	62		
Future Volume (veh/h)	1457	503	85	1203	242	62		
Number	6	16	5	2	3	18		
Initial Q (Qb), veh	0	0	0	0	0	0		
Ped-Bike Adj(A_pbT)		1.00	1.00		1.00	1.00		
Parking Bus, Adj	1.00	1.00	1.00	1.00	1.00	1.00		
Adj Sat Flow, veh/h/ln	1863	1863	1863	1863	1863	1863		
Adj Flow Rate, veh/h	1777	0	104	1467	295	0		
Adj No. of Lanes	1	1	1	2	1	1		
Peak Hour Factor	0.82	0.82	0.82	0.82	0.82	0.82		
Percent Heavy Veh, %	2	2	2	2	2	2		
Cap, veh/h	993	844	131	0	328	409		
Arrive On Green	0.53	0.00	0.07	0.00	0.18	0.00		
Sat Flow, veh/h	1863	1583	1774	104	1774	1583		
Grp Volume(v), veh/h	1777	0	104	55.9	295	0		
Grp Sat Flow(s),veh/h/ln	1863	1583	1774	E	1774	1583		
Q Serve(g_s), s	53.3	0.0	5.8		16.3	0.0		
Cycle Q Clear(g_c), s	53.3	0.0	5.8		16.3	0.0		
Prop In Lane		1.00	1.00		1.00	1.00		
Lane Grp Cap(c), veh/h	993	844	131		328	409		
V/C Ratio(X)	1.79	0.00	0.80		0.90	0.00		
Avail Cap(c_a), veh/h	993	844	190		385	460		
HCM Platoon Ratio	1.00	1.00	1.00		1.00	1.00		
Upstream Filter(I)	1.00	0.00	1.00		1.00	0.00		
Uniform Delay (d), s/veh	23.4	0.0	45.6		39.9	0.0		
Incr Delay (d2), s/veh	359.5	0.0	10.3		20.3	0.0		
Initial Q Delay(d3),s/veh	0.0	0.0	0.0		0.0	0.0		
%ile BackOfQ(50%),veh/ln	126.2	0.0	3.2		9.8	0.0		
LnGrp Delay(d),s/veh	382.8	0.0	55.9		60.2	0.0		
LnGrp LOS	F		E		E			
Approach Vol, veh/h	1777				295			
Approach Delay, s/veh	382.8				60.2			
Approach LOS	F				E			
Timer	1	2	3	4	5	6	7	8
Assigned Phs					5	6		8
Phs Duration (G+Y+Rc), s					11.7	59.0		22.8
Change Period (Y+Rc), s					4.3	* 5.7		4.3
Max Green Setting (Gmax), s					10.7	* 53		21.7
Max Q Clear Time (g_c+I1), s					7.8	55.3		18.3
Green Ext Time (p_c), s					0.0	0.0		0.2
<b>Intersection Summary</b>								
HCM 2010 Ctrl Delay			323.5					
HCM 2010 LOS			F					
<b>Notes</b>								



Movement	EBT	EBR	WBL	WBT	NBL	NBR		
Lane Configurations	↑	↗	↖	↑↑	↖	↗		
Traffic Volume (veh/h)	779	165	24	1353	487	89		
Future Volume (veh/h)	779	165	24	1353	487	89		
Number	6	16	5	2	3	18		
Initial Q (Qb), veh	0	0	0	0	0	0		
Ped-Bike Adj(A_pbT)		1.00	1.00		1.00	1.00		
Parking Bus, Adj	1.00	1.00	1.00	1.00	1.00	1.00		
Adj Sat Flow, veh/h/ln	1863	1863	1863	1863	1863	1863		
Adj Flow Rate, veh/h	950	0	29	1650	594	109		
Adj No. of Lanes	1	1	1	2	1	1		
Peak Hour Factor	0.82	0.82	0.82	0.82	0.82	0.82		
Percent Heavy Veh, %	2	2	2	2	2	2		
Cap, veh/h	602	511	36	0	631	595		
Arrive On Green	0.32	0.00	0.02	0.00	0.36	0.36		
Sat Flow, veh/h	1863	1583	1774	29	1774	1583		
Grp Volume(v), veh/h	950	0	29	71.5	594	109		
Grp Sat Flow(s),veh/h/ln	1863	1583	1774	E	1774	1583		
Q Serve(g_s), s	32.3	0.0	1.6		32.4	2.6		
Cycle Q Clear(g_c), s	32.3	0.0	1.6		32.4	2.6		
Prop In Lane		1.00	1.00		1.00	1.00		
Lane Grp Cap(c), veh/h	602	511	36		631	595		
V/C Ratio(X)	1.58	0.00	0.81		0.94	0.18		
Avail Cap(c_a), veh/h	602	511	165		745	697		
HCM Platoon Ratio	1.00	1.00	1.00		1.00	1.00		
Upstream Filter(I)	1.00	0.00	1.00		1.00	1.00		
Uniform Delay (d), s/veh	33.9	0.0	48.8		31.2	20.9		
Incr Delay (d2), s/veh	268.4	0.0	22.7		17.8	0.1		
Initial Q Delay(d3),s/veh	0.0	0.0	0.0		0.0	0.0		
%ile BackOfQ(50%),veh/ln	61.4	0.0	1.0		19.0	1.1		
LnGrp Delay(d),s/veh	302.3	0.0	71.5		49.1	21.0		
LnGrp LOS	F		E		D	C		
Approach Vol, veh/h	950				703			
Approach Delay, s/veh	302.3				44.7			
Approach LOS	F				D			
Timer	1	2	3	4	5	6	7	8
Assigned Phs					5	6		8
Phs Duration (G+Y+Rc), s					7.7	38.0		40.5
Change Period (Y+Rc), s					5.7	5.7		5.0
Max Green Setting (Gmax), s					9.3	32.3		42.0
Max Q Clear Time (g_c+I1), s					3.6	34.3		34.4
Green Ext Time (p_c), s					0.0	0.0		1.1
<b>Intersection Summary</b>								
HCM 2010 Ctrl Delay			190.7					
HCM 2010 LOS			F					



















































Movement	EBT	EBR	WBL	WBT	NBL	NBR		
Lane Configurations	↑	↗	↖	↑↑	↖	↗		
Traffic Volume (veh/h)	1268	438	74	1047	211	54		
Future Volume (veh/h)	1268	438	74	1047	211	54		
Number	6	16	5	2	3	18		
Initial Q (Qb), veh	0	0	0	0	0	0		
Ped-Bike Adj(A_pbT)		1.00	1.00		1.00	1.00		
Parking Bus, Adj	1.00	1.00	1.00	1.00	1.00	1.00		
Adj Sat Flow, veh/h/ln	1863	1863	1863	1863	1863	1863		
Adj Flow Rate, veh/h	1546	0	90	1277	257	0		
Adj No. of Lanes	1	1	1	2	1	1		
Peak Hour Factor	0.82	0.82	0.82	0.82	0.82	0.82		
Percent Heavy Veh, %	2	2	2	2	2	2		
Cap, veh/h	993	844	115	0	291	362		
Arrive On Green	0.53	0.00	0.06	0.00	0.16	0.00		
Sat Flow, veh/h	1863	1583	1774	90	1774	1583		
Grp Volume(v), veh/h	1546	0	90	53.2	257	0		
Grp Sat Flow(s),veh/h/ln	1863	1583	1774	D	1774	1583		
Q Serve(g_s), s	53.3	0.0	5.0		14.2	0.0		
Cycle Q Clear(g_c), s	53.3	0.0	5.0		14.2	0.0		
Prop In Lane		1.00	1.00		1.00	1.00		
Lane Grp Cap(c), veh/h	993	844	115		291	362		
V/C Ratio(X)	1.56	0.00	0.79		0.88	0.00		
Avail Cap(c_a), veh/h	993	844	190		385	446		
HCM Platoon Ratio	1.00	1.00	1.00		1.00	1.00		
Upstream Filter(I)	1.00	0.00	1.00		1.00	0.00		
Uniform Delay (d), s/veh	23.4	0.0	46.1		40.9	0.0		
Incr Delay (d2), s/veh	255.7	0.0	7.1		15.3	0.0		
Initial Q Delay(d3),s/veh	0.0	0.0	0.0		0.0	0.0		
%ile BackOfQ(50%),veh/ln	97.5	0.0	2.7		8.2	0.0		
LnGrp Delay(d),s/veh	279.0	0.0	53.2		56.2	0.0		
LnGrp LOS	F		D		E			
Approach Vol, veh/h	1546				257			
Approach Delay, s/veh	279.0				56.2			
Approach LOS	F				E			
Timer	1	2	3	4	5	6	7	8
Assigned Phs					5	6		8
Phs Duration (G+Y+Rc), s					10.8	59.0		20.7
Change Period (Y+Rc), s					4.3	* 5.7		4.3
Max Green Setting (Gmax), s					10.7	* 53		21.7
Max Q Clear Time (g_c+11), s					7.0	55.3		16.2
Green Ext Time (p_c), s					0.0	0.0		0.2
<b>Intersection Summary</b>								
HCM 2010 Ctrl Delay			238.0					
HCM 2010 LOS			F					
<b>Notes</b>								

HCM 2010 Signalized Intersection Summary  
4: Three Springs Road & US 160

Existing Conditions Summer AM (550 Closure)

01/08/2019

												
Movement	EBL	EBT	EBR	WBL	WBT	WBR	NBL	NBT	NBR	SBL	SBT	SBR
Lane Configurations												
Traffic Volume (veh/h)	420	837	2	28	2164	268	30	9	12	60	3	151
Future Volume (veh/h)	420	837	2	28	2164	268	30	9	12	60	3	151
Number	1	6	16	5	2	12	3	8	18	7	4	14
Initial Q (Qb), veh	0	0	0	0	0	0	0	0	0	0	0	0
Ped-Bike Adj(A_pbT)	1.00		1.00	1.00		1.00	1.00		1.00	1.00		1.00
Parking Bus, Adj	1.00	1.00	1.00	1.00	1.00	1.00	1.00	1.00	1.00	1.00	1.00	1.00
Adj Sat Flow, veh/h/ln	1740	1707	1740	1740	1707	1740	1740	1740	1740	1740	1740	1740
Adj Flow Rate, veh/h	488	973	0	36	2810	0	43	13	0	78	4	0
Adj No. of Lanes	2	2	1	1	2	1	1	1	1	2	1	1
Peak Hour Factor	0.86	0.86	0.86	0.77	0.77	0.77	0.69	0.69	0.69	0.77	0.77	0.77
Percent Heavy Veh, %	2	4	2	2	4	2	2	2	2	2	2	2
Cap, veh/h	563	2324	1031	52	1858	818	181	74	48	357	82	55
Arrive On Green	0.17	0.72	0.00	0.03	0.57	0.00	0.03	0.04	0.00	0.04	0.05	0.00
Sat Flow, veh/h	3215	3243	1479	1657	3243	1479	1657	1740	1479	3215	1740	1479
Grp Volume(v), veh/h	488	973	0	36	2810	0	43	13	0	78	4	0
Grp Sat Flow(s),veh/h/ln	1608	1621	1479	1657	1621	1479	1657	1740	1479	1608	1740	1479
Q Serve(g_s), s	14.8	12.1	0.0	2.2	57.3	0.0	0.0	0.7	0.0	0.0	0.2	0.0
Cycle Q Clear(g_c), s	14.8	12.1	0.0	2.2	57.3	0.0	0.0	0.7	0.0	0.0	0.2	0.0
Prop In Lane	1.00		1.00	1.00		1.00	1.00		1.00	1.00		1.00
Lane Grp Cap(c), veh/h	563	2324	1031	52	1858	818	181	74	48	357	82	55
V/C Ratio(X)	0.87	0.42	0.00	0.69	1.51	0.00	0.24	0.18	0.00	0.22	0.05	0.00
Avail Cap(c_a), veh/h	563	2324	1031	96	1858	818	241	118	86	458	118	86
HCM Platoon Ratio	1.00	1.00	1.00	1.00	1.00	1.00	1.00	1.00	1.00	1.00	1.00	1.00
Upstream Filter(I)	1.00	1.00	0.00	1.00	1.00	0.00	1.00	1.00	0.00	1.00	1.00	0.00
Uniform Delay (d), s/veh	40.1	5.7	0.0	48.0	21.4	0.0	44.4	46.2	0.0	44.4	45.5	0.0
Incr Delay (d2), s/veh	13.2	0.6	0.0	9.8	233.4	0.0	0.4	0.7	0.0	0.2	0.1	0.0
Initial Q Delay(d3),s/veh	0.0	0.0	0.0	0.0	0.0	0.0	0.0	0.0	0.0	0.0	0.0	0.0
%ile BackOfQ(50%),veh/ln	7.6	5.6	0.0	1.1	85.5	0.0	1.2	0.4	0.0	1.0	0.1	0.0
LnGrp Delay(d),s/veh	53.3	6.3	0.0	57.7	254.7	0.0	44.8	46.9	0.0	44.5	45.6	0.0
LnGrp LOS	D	A		E	F		D	D		D	D	
Approach Vol, veh/h		1461			2846			56			82	
Approach Delay, s/veh		22.0			252.2			45.3			44.6	
Approach LOS		C			F			D			D	
Timer	1	2	3	4	5	6	7	8				
Assigned Phs	1	2	3	4	5	6	7	8				
Phs Duration (G+Y+Rc), s	22.7	61.0	7.4	8.9	8.3	75.4	7.9	8.4				
Change Period (Y+Rc), s	5.7	5.7	* 5.2	* 5.2	5.7	5.7	* 5.2	* 5.2				
Max Green Setting (Gmax), s	11.3	55.3	* 5.8	* 5.8	5.3	61.3	* 5.8	* 5.8				
Max Q Clear Time (g_c+1), s	16.8	59.3	2.0	2.2	4.2	14.1	2.0	2.7				
Green Ext Time (p_c), s	0.0	0.0	0.1	0.0	0.0	7.0	0.1	0.0				
<b>Intersection Summary</b>												
HCM 2010 Ctrl Delay				170.1								
HCM 2010 LOS				F								
<b>Notes</b>												

												
Movement	EBL	EBT	EBR	WBL	WBT	WBR	NBL	NBT	NBR	SBL	SBT	SBR
Lane Configurations												
Traffic Volume (veh/h)	39	251	470	101	997	18	1273	41	98	21	60	217
Future Volume (veh/h)	39	251	470	101	997	18	1273	41	98	21	60	217
Number	1	6	16	5	2	12	3	8	18	7	4	14
Initial Q (Qb), veh	0	0	0	0	0	0	0	0	0	0	0	0
Ped-Bike Adj(A_pbT)	1.00		1.00	1.00		1.00	1.00		1.00	1.00		1.00
Parking Bus, Adj	1.00	1.00	1.00	1.00	1.00	1.00	1.00	1.00	1.00	1.00	1.00	1.00
Adj Sat Flow, veh/h/ln	1740	1690	1740	1740	1690	1740	1740	1740	1740	1740	1740	1740
Adj Flow Rate, veh/h	41	264	0	133	1312	0	1759	0	0	27	76	0
Adj No. of Lanes	1	2	1	1	2	1	2	0	1	1	1	1
Peak Hour Factor	0.95	0.95	0.95	0.76	0.76	0.76	0.74	0.74	0.74	0.79	0.79	0.79
Percent Heavy Veh, %	2	5	2	2	5	2	2	2	2	2	2	2
Cap, veh/h	58	1510	696	633	1606	740	729	0	311	116	121	88
Arrive On Green	0.04	0.47	0.00	0.06	0.50	0.00	0.22	0.00	0.00	0.07	0.07	0.00
Sat Flow, veh/h	1657	3212	1479	1657	3212	1479	3315	0	1479	1657	1740	1479
Grp Volume(v), veh/h	41	264	0	133	1312	0	1759	0	0	27	76	0
Grp Sat Flow(s),veh/h/ln	1657	1606	1479	1657	1606	1479	1657	0	1479	1657	1740	1479
Q Serve(g_s), s	2.4	4.7	0.0	4.2	34.5	0.0	22.0	0.0	0.0	1.5	4.2	0.0
Cycle Q Clear(g_c), s	2.4	4.7	0.0	4.2	34.5	0.0	22.0	0.0	0.0	1.5	4.2	0.0
Prop In Lane	1.00		1.00	1.00		1.00	1.00		1.00	1.00		1.00
Lane Grp Cap(c), veh/h	58	1510	696	633	1606	740	729	0	311	116	121	88
V/C Ratio(X)	0.70	0.17	0.00	0.21	0.82	0.00	2.41	0.00	0.00	0.23	0.63	0.00
Avail Cap(c_a), veh/h	108	1510	696	633	1606	740	729	0	311	232	244	192
HCM Platoon Ratio	1.00	1.00	1.00	1.00	1.00	1.00	1.00	1.00	1.00	1.00	1.00	1.00
Upstream Filter(I)	1.00	1.00	0.00	1.00	1.00	0.00	1.00	0.00	0.00	1.00	1.00	0.00
Uniform Delay (d), s/veh	47.7	15.3	0.0	12.6	21.1	0.0	39.0	0.0	0.0	44.0	45.2	0.0
Incr Delay (d2), s/veh	9.0	0.3	0.0	0.2	4.7	0.0	639.7	0.0	0.0	0.6	3.2	0.0
Initial Q Delay(d3),s/veh	0.0	0.0	0.0	0.0	0.0	0.0	0.0	0.0	0.0	0.0	0.0	0.0
%ile BackOfQ(50%),veh/ln	1.3	2.1	0.0	1.9	16.4	0.0	74.8	0.0	0.0	0.7	2.2	0.0
LnGrp Delay(d),s/veh	56.7	15.5	0.0	12.8	25.9	0.0	678.7	0.0	0.0	44.6	48.5	0.0
LnGrp LOS	E	B		B	C		F			D	D	
Approach Vol, veh/h		305			1445			1759			103	
Approach Delay, s/veh		21.1			24.7			678.7			47.5	
Approach LOS		C			C			F			D	
Timer	1	2	3	4	5	6	7	8				
Assigned Phs	1	2		4	5	6		8				
Phs Duration (G+Y+Rc), s	9.0	54.0		11.0	12.0	51.0		26.0				
Change Period (Y+Rc), s	6.0	6.0		5.0	6.0	6.0		5.0				
Max Green Setting (Gmax), s	6.0	38.0		13.0	6.0	38.0		21.0				
Max Q Clear Time (g_c+I1), s	4.4	36.5		6.2	6.2	6.7		24.0				
Green Ext Time (p_c), s	0.0	1.4		0.1	0.0	27.6		0.0				
<b>Intersection Summary</b>												
HCM 2010 Ctrl Delay			343.5									
HCM 2010 LOS			F									
<b>Notes</b>												



Intersection												
Int Delay, s/veh	3											
Movement	EBL	EBT	EBR	WBL	WBT	WBR	NBL	NBT	NBR	SBL	SBT	SBR
Lane Configurations		↑	↗		↕		↖	↑	↗	↖	↑	↗
Traffic Vol, veh/h	43	5	12	3	5	68	20	1213	2	20	495	23
Future Vol, veh/h	43	5	12	3	5	68	20	1213	2	20	495	23
Conflicting Peds, #/hr	0	0	0	0	0	0	0	0	0	0	0	0
Sign Control	Stop	Stop	Stop	Stop	Stop	Stop	Free	Free	Free	Free	Free	Free
RT Channelized	-	-	Stop	-	-	None	-	-	None	-	-	None
Storage Length	-	-	170	-	-	-	140	-	280	540	-	430
Veh in Median Storage, #	-	0	-	-	0	-	-	0	-	-	0	-
Grade, %	-	0	-	-	0	-	-	0	-	-	0	-
Peak Hour Factor	94	94	94	94	94	94	94	94	94	94	94	94
Heavy Vehicles, %	2	2	2	2	2	2	2	2	2	2	2	2
Mvmt Flow	46	5	13	3	5	72	21	1290	2	21	527	24

Major/Minor	Minor2		Minor1		Major1		Major2					
Conflicting Flow All	1941	1902	527	1905	1902	1290	527	0	0	1290	0	0
Stage 1	569	569	-	1333	1333	-	-	-	-	-	-	-
Stage 2	1372	1333	-	572	569	-	-	-	-	-	-	-
Critical Hdwy	7.12	6.52	6.22	7.12	6.52	6.22	4.12	-	-	4.12	-	-
Critical Hdwy Stg 1	6.12	5.52	-	6.12	5.52	-	-	-	-	-	-	-
Critical Hdwy Stg 2	6.12	5.52	-	6.12	5.52	-	-	-	-	-	-	-
Follow-up Hdwy	3.518	4.018	3.318	3.518	4.018	3.318	2.218	-	-	2.218	-	-
Pot Cap-1 Maneuver	49	69	551	52	69	200	1040	-	-	538	-	-
Stage 1	507	506	-	190	223	-	-	-	-	-	-	-
Stage 2	180	223	-	505	506	-	-	-	-	-	-	-
Platoon blocked, %								-	-	-	-	-
Mov Cap-1 Maneuver	~ 28	65	551	46	65	200	1040	-	-	538	-	-
Mov Cap-2 Maneuver	~ 28	65	-	46	65	-	-	-	-	-	-	-
Stage 1	497	486	-	186	218	-	-	-	-	-	-	-
Stage 2	110	218	-	469	486	-	-	-	-	-	-	-

























Approach	EB		WB		NB		SB	
HCM Control Delay, s	27.5		49.5		0.1		0.4	
HCM LOS	D		E					

























Minor Lane/Major Mvmt	NBL	NBT	NBR	EBLn1	EBLn2	WBLn1	SBL	SBT	SBR
Capacity (veh/h)	1040	-	-	65	551	158	538	-	-
HCM Lane V/C Ratio	0.02	-	-	0.082	0.023	0.512	0.04	-	-
HCM Control Delay (s)	8.5	-	-	65.3	11.7	49.5	12	-	-
HCM Lane LOS	A	-	-	F	B	E	B	-	-
HCM 95th %tile Q(veh)	0.1	-	-	0.3	0.1	2.5	0.1	-	-

Notes  
 ~: Volume exceeds capacity    \$: Delay exceeds 300s    +: Computation Not Defined    \*: All major volume in platoon

HCM 2010 Signalized Intersection Summary  
4: Three Springs Road & US 160

Existing Conditions Summer PM (550 Closure)  
01/08/2019

												
Movement	EBL	EBT	EBR	WBL	WBT	WBR	NBL	NBT	NBR	SBL	SBT	SBR
Lane Configurations												
Traffic Volume (veh/h)	196	2029	7	18	693	66	13	10	18	199	8	414
Future Volume (veh/h)	196	2029	7	18	693	66	13	10	18	199	8	414
Number	1	6	16	5	2	12	3	8	18	7	4	14
Initial Q (Qb), veh	0	0	0	0	0	0	0	0	0	0	0	0
Ped-Bike Adj(A_pbT)	1.00		1.00	1.00		1.00	1.00		1.00	1.00		1.00
Parking Bus, Adj	1.00	1.00	1.00	1.00	1.00	1.00	1.00	1.00	1.00	1.00	1.00	1.00
Adj Sat Flow, veh/h/ln	1740	1707	1740	1740	1707	1740	1740	1740	1740	1740	1740	1740
Adj Flow Rate, veh/h	231	2387	0	19	729	0	23	18	0	243	10	0
Adj No. of Lanes	2	2	1	1	2	1	1	1	1	2	1	1
Peak Hour Factor	0.85	0.85	0.85	0.95	0.95	0.95	0.56	0.56	0.56	0.82	0.82	0.82
Percent Heavy Veh, %	2	4	2	2	4	2	2	2	2	2	2	2
Cap, veh/h	436	2273	1007	30	1891	833	169	70	45	363	87	59
Arrive On Green	0.14	0.70	0.00	0.02	0.58	0.00	0.06	0.04	0.00	0.07	0.05	0.00
Sat Flow, veh/h	3215	3243	1479	1657	3243	1479	1657	1740	1479	3215	1740	1479
Grp Volume(v), veh/h	231	2387	0	19	729	0	23	18	0	243	10	0
Grp Sat Flow(s),veh/h/ln	1608	1621	1479	1657	1621	1479	1657	1740	1479	1608	1740	1479
Q Serve(g_s), s	6.7	70.1	0.0	1.1	12.1	0.0	0.0	1.0	0.0	6.8	0.5	0.0
Cycle Q Clear(g_c), s	6.7	70.1	0.0	1.1	12.1	0.0	0.0	1.0	0.0	6.8	0.5	0.0
Prop In Lane	1.00		1.00	1.00		1.00	1.00		1.00	1.00		1.00
Lane Grp Cap(c), veh/h	436	2273	1007	30	1891	833	169	70	45	363	87	59
V/C Ratio(X)	0.53	1.05	0.00	0.64	0.39	0.00	0.14	0.26	0.00	0.67	0.11	0.00
Avail Cap(c_a), veh/h	436	2273	1007	96	1891	833	185	118	86	363	118	86
HCM Platoon Ratio	1.00	1.00	1.00	1.00	1.00	1.00	1.00	1.00	1.00	1.00	1.00	1.00
Upstream Filter(I)	1.00	1.00	0.00	1.00	1.00	0.00	1.00	1.00	0.00	1.00	1.00	0.00
Uniform Delay (d), s/veh	40.2	15.0	0.0	48.8	11.2	0.0	44.3	46.5	0.0	46.9	45.4	0.0
Incr Delay (d2), s/veh	0.8	33.7	0.0	13.2	0.6	0.0	0.2	1.2	0.0	4.2	0.4	0.0
Initial Q Delay(d3),s/veh	0.0	0.0	0.0	0.0	0.0	0.0	0.0	0.0	0.0	0.0	0.0	0.0
%ile BackOfQ(50%),veh/ln	3.0	41.3	0.0	0.6	5.5	0.0	0.6	0.5	0.0	0.5	0.3	0.0
LnGrp Delay(d),s/veh	41.1	48.7	0.0	62.0	11.8	0.0	44.6	47.7	0.0	51.0	45.7	0.0
LnGrp LOS	D	F		E	B		D	D		D	D	
Approach Vol, veh/h		2618			748			41			253	
Approach Delay, s/veh		48.0			13.1			45.9			50.8	
Approach LOS		D			B			D			D	
Timer	1	2	3	4	5	6	7	8				
Assigned Phs	1	2	3	4	5	6	7	8				
Phs Duration (G+Y+Rc), s	18.8	62.0	10.0	9.2	7.0	73.8	11.0	8.2				
Change Period (Y+Rc), s	5.7	5.7	* 5.2	* 5.2	5.7	5.7	* 5.2	* 5.2				
Max Green Setting (Gmax), s	10.3	56.3	* 5.8	* 5.8	5.3	61.3	* 5.8	* 5.8				
Max Q Clear Time (g_c+1), s	8.7	14.1	2.0	2.5	3.1	72.1	8.8	3.0				
Green Ext Time (p_c), s	0.1	3.5	0.0	0.0	0.0	0.0	0.0	0.0				
<b>Intersection Summary</b>												
HCM 2010 Ctrl Delay			41.1									
HCM 2010 LOS			D									
<b>Notes</b>												

























												
Movement	EBL	EBT	EBR	WBL	WBT	WBR	NBL	NBT	NBR	SBL	SBT	SBR
Lane Configurations												
Traffic Volume (veh/h)	221	906	719	59	313	35	644	69	99	52	53	82
Future Volume (veh/h)	221	906	719	59	313	35	644	69	99	52	53	82
Number	1	6	16	5	2	12	3	8	18	7	4	14
Initial Q (Qb), veh	0	0	0	0	0	0	0	0	0	0	0	0
Ped-Bike Adj(A_pbT)	1.00		1.00	1.00		1.00	1.00		1.00	1.00		1.00
Parking Bus, Adj	1.00	1.00	1.00	1.00	1.00	1.00	1.00	1.00	1.00	1.00	1.00	1.00
Adj Sat Flow, veh/h/ln	1740	1690	1740	1740	1690	1740	1740	1740	1740	1740	1740	1740
Adj Flow Rate, veh/h	235	964	0	69	368	0	771	0	0	59	60	0
Adj No. of Lanes	1	2	1	1	2	1	2	0	1	1	1	1
Peak Hour Factor	0.94	0.94	0.94	0.85	0.85	0.85	0.90	0.90	0.90	0.88	0.88	0.88
Percent Heavy Veh, %	2	5	2	2	5	2	2	2	2	2	2	2
Cap, veh/h	577	1525	702	95	1436	661	762	0	325	105	110	78
Arrive On Green	0.09	0.47	0.00	0.06	0.45	0.00	0.23	0.00	0.00	0.06	0.06	0.00
Sat Flow, veh/h	1657	3212	1479	1657	3212	1479	3315	0	1479	1657	1740	1479
Grp Volume(v), veh/h	235	964	0	69	368	0	771	0	0	59	60	0
Grp Sat Flow(s),veh/h/ln	1657	1606	1479	1657	1606	1479	1657	0	1479	1657	1740	1479
Q Serve(g_s), s	8.0	22.5	0.0	4.1	7.2	0.0	23.0	0.0	0.0	3.5	3.3	0.0
Cycle Q Clear(g_c), s	8.0	22.5	0.0	4.1	7.2	0.0	23.0	0.0	0.0	3.5	3.3	0.0
Prop In Lane	1.00		1.00	1.00		1.00	1.00		1.00	1.00		1.00
Lane Grp Cap(c), veh/h	577	1525	702	95	1436	661	762	0	325	105	110	78
V/C Ratio(X)	0.41	0.63	0.00	0.73	0.26	0.00	1.01	0.00	0.00	0.56	0.55	0.00
Avail Cap(c_a), veh/h	577	1525	702	141	1436	661	762	0	325	149	157	118
HCM Platoon Ratio	1.00	1.00	1.00	1.00	1.00	1.00	1.00	1.00	1.00	1.00	1.00	1.00
Upstream Filter(I)	1.00	1.00	0.00	1.00	1.00	0.00	1.00	0.00	0.00	1.00	1.00	0.00
Uniform Delay (d), s/veh	13.9	19.7	0.0	46.4	17.3	0.0	38.5	0.0	0.0	45.5	45.5	0.0
Incr Delay (d2), s/veh	0.3	2.0	0.0	6.4	0.4	0.0	35.4	0.0	0.0	2.9	2.6	0.0
Initial Q Delay(d3),s/veh	0.0	0.0	0.0	0.0	0.0	0.0	0.0	0.0	0.0	0.0	0.0	0.0
%ile BackOfQ(50%),veh/ln	3.6	10.3	0.0	2.0	3.3	0.0	14.2	0.0	0.0	1.7	1.7	0.0
LnGrp Delay(d),s/veh	14.2	21.7	0.0	52.8	17.7	0.0	73.9	0.0	0.0	48.4	48.0	0.0
LnGrp LOS	B	C		D	B		F			D	D	
Approach Vol, veh/h		1199			437			771			119	
Approach Delay, s/veh		20.2			23.2			73.9			48.2	
Approach LOS		C			C			E			D	
Timer	1	2	3	4	5	6	7	8				
Assigned Phs	1	2		4	5	6		8				
Phs Duration (G+Y+Rc), s	14.0	48.7		10.3	11.2	51.5		27.0				
Change Period (Y+Rc), s	6.0	6.0		5.0	6.0	6.0		5.0				
Max Green Setting (Gmax), s	8.0	40.0		8.0	8.0	40.0		22.0				
Max Q Clear Time (g_c+1), s	10.0	9.2		5.5	6.1	24.5		25.0				
Green Ext Time (p_c), s	0.0	23.9		0.0	0.0	13.2		0.0				
<b>Intersection Summary</b>												
HCM 2010 Ctrl Delay			38.5									
HCM 2010 LOS			D									
<b>Notes</b>												

























Intersection												
Int Delay, s/veh	1.7											
Movement	EBL	EBT	EBR	WBL	WBT	WBR	NBL	NBT	NBR	SBL	SBT	SBR
Lane Configurations		↑	↗		↕		↖	↑	↗	↖	↑	↗
Traffic Vol, veh/h	21	2	43	5	5	28	20	681	5	38	657	36
Future Vol, veh/h	21	2	43	5	5	28	20	681	5	38	657	36
Conflicting Peds, #/hr	0	0	0	0	0	0	0	0	0	0	0	0
Sign Control	Stop	Stop	Stop	Stop	Stop	Stop	Free	Free	Free	Free	Free	Free
RT Channelized	-	-	Stop	-	-	None	-	-	None	-	-	None
Storage Length	-	-	170	-	-	-	140	-	280	540	-	430
Veh in Median Storage, #	-	0	-	-	0	-	-	0	-	-	0	-
Grade, %	-	0	-	-	0	-	-	0	-	-	0	-
Peak Hour Factor	94	94	94	94	94	94	94	94	94	94	94	94
Heavy Vehicles, %	2	2	2	2	2	2	2	2	2	2	2	2
Mvmt Flow	22	2	46	5	5	30	21	724	5	40	699	38

Major/Minor	Minor2		Minor1		Major1		Major2					
Conflicting Flow All	1565	1547	699	1548	1547	724	699	0	0	724	0	0
Stage 1	780	780	-	767	767	-	-	-	-	-	-	-
Stage 2	785	767	-	781	780	-	-	-	-	-	-	-
Critical Hdwy	7.12	6.52	6.22	7.12	6.52	6.22	4.12	-	-	4.12	-	-
Critical Hdwy Stg 1	6.12	5.52	-	6.12	5.52	-	-	-	-	-	-	-
Critical Hdwy Stg 2	6.12	5.52	-	6.12	5.52	-	-	-	-	-	-	-
Follow-up Hdwy	3.518	4.018	3.318	3.518	4.018	3.318	2.218	-	-	2.218	-	-
Pot Cap-1 Maneuver	90	114	440	93	114	426	898	-	-	879	-	-
Stage 1	388	406	-	395	411	-	-	-	-	-	-	-
Stage 2	386	411	-	388	406	-	-	-	-	-	-	-
Platoon blocked, %								-	-	-	-	-
Mov Cap-1 Maneuver	76	106	440	78	106	426	898	-	-	879	-	-
Mov Cap-2 Maneuver	76	106	-	78	106	-	-	-	-	-	-	-
Stage 1	379	388	-	386	401	-	-	-	-	-	-	-
Stage 2	346	401	-	330	388	-	-	-	-	-	-	-

Approach	EB		WB		NB		SB	
HCM Control Delay, s	15.2		25.6		0.3		0.5	
HCM LOS	C		D					

Minor Lane/Major Mvmt	NBL	NBT	NBR	EBLn1	EBLn2	WBLn1	SBL	SBT	SBR
Capacity (veh/h)	898	-	-	106	440	215	879	-	-
HCM Lane V/C Ratio	0.024	-	-	0.02	0.104	0.188	0.046	-	-
HCM Control Delay (s)	9.1	-	-	39.7	14.1	25.6	9.3	-	-
HCM Lane LOS	A	-	-	E	B	D	A	-	-
HCM 95th %tile Q(veh)	0.1	-	-	0.1	0.3	0.7	0.1	-	-

												
Movement	EBL	EBT	EBR	WBL	WBT	WBR	NBL	NBT	NBR	SBL	SBT	SBR
Lane Configurations												
Traffic Volume (veh/h)	364	726	2	24	1881	233	26	8	10	52	3	130
Future Volume (veh/h)	364	726	2	24	1881	233	26	8	10	52	3	130
Number	1	6	16	5	2	12	3	8	18	7	4	14
Initial Q (Qb), veh	0	0	0	0	0	0	0	0	0	0	0	0
Ped-Bike Adj(A_pbT)	1.00		1.00	1.00		1.00	1.00		1.00	1.00		1.00
Parking Bus, Adj	1.00	1.00	1.00	1.00	1.00	1.00	1.00	1.00	1.00	1.00	1.00	1.00
Adj Sat Flow, veh/h/ln	1863	1827	1863	1863	1827	1863	1765	1765	1863	1863	1765	1863
Adj Flow Rate, veh/h	423	844	0	31	2443	0	38	12	0	68	4	0
Adj No. of Lanes	2	2	1	1	2	1	1	1	1	2	1	1
Peak Hour Factor	0.86	0.86	0.86	0.77	0.77	0.77	0.69	0.69	0.69	0.77	0.77	0.77
Percent Heavy Veh, %	2	4	2	2	4	2	2	2	2	2	2	2
Cap, veh/h	680	2513	1115	47	1920	844	175	72	49	360	81	57
Arrive On Green	0.20	0.72	0.00	0.03	0.55	0.00	0.03	0.04	0.00	0.04	0.05	0.00
Sat Flow, veh/h	3442	3471	1583	1774	3471	1583	1681	1765	1583	3442	1765	1583
Grp Volume(v), veh/h	423	844	0	31	2443	0	38	12	0	68	4	0
Grp Sat Flow(s),veh/h/ln	1721	1736	1583	1774	1736	1583	1681	1765	1583	1721	1765	1583
Q Serve(g_s), s	11.2	8.9	0.0	1.7	55.3	0.0	0.0	0.7	0.0	0.0	0.2	0.0
Cycle Q Clear(g_c), s	11.2	8.9	0.0	1.7	55.3	0.0	0.0	0.7	0.0	0.0	0.2	0.0
Prop In Lane	1.00		1.00	1.00		1.00	1.00		1.00	1.00		1.00
Lane Grp Cap(c), veh/h	680	2513	1115	47	1920	844	175	72	49	360	81	57
V/C Ratio(X)	0.62	0.34	0.00	0.66	1.27	0.00	0.22	0.17	0.00	0.19	0.05	0.00
Avail Cap(c_a), veh/h	680	2513	1115	103	1920	844	238	120	92	472	120	92
HCM Platoon Ratio	1.00	1.00	1.00	1.00	1.00	1.00	1.00	1.00	1.00	1.00	1.00	1.00
Upstream Filter(I)	1.00	1.00	0.00	1.00	1.00	0.00	1.00	1.00	0.00	1.00	1.00	0.00
Uniform Delay (d), s/veh	36.7	5.0	0.0	48.2	22.4	0.0	44.6	46.3	0.0	44.4	45.6	0.0
Incr Delay (d2), s/veh	1.5	0.4	0.0	9.2	126.9	0.0	0.4	0.6	0.0	0.2	0.2	0.0
Initial Q Delay(d3),s/veh	0.0	0.0	0.0	0.0	0.0	0.0	0.0	0.0	0.0	0.0	0.0	0.0
%ile BackOfQ(50%),veh/ln	5.5	4.3	0.0	1.0	60.0	0.0	1.0	0.3	0.0	0.9	0.1	0.0
LnGrp Delay(d),s/veh	38.2	5.4	0.0	57.4	149.3	0.0	45.0	46.9	0.0	44.5	45.7	0.0
LnGrp LOS	D	A		E	F		D	D		D	D	
Approach Vol, veh/h		1267			2474			50			72	
Approach Delay, s/veh		16.4			148.1			45.4			44.6	
Approach LOS		B			F			D			D	
Timer	1	2	3	4	5	6	7	8				
Assigned Phs	1	2	3	4	5	6	7	8				
Phs Duration (G+Y+Rc), s	24.9	59.0	7.2	8.8	7.9	76.1	7.7	8.3				
Change Period (Y+Rc), s	5.7	5.7	* 5.2	* 5.2	5.7	5.7	* 5.2	* 5.2				
Max Green Setting (Gmax), s	13.3	53.3	* 5.8	* 5.8	5.3	61.3	* 5.8	* 5.8				
Max Q Clear Time (g_c+1), s	13.2	57.3	2.0	2.2	3.7	10.9	2.0	2.7				
Green Ext Time (p_c), s	0.0	0.0	0.1	0.0	0.0	5.7	0.1	0.0				
<b>Intersection Summary</b>												
HCM 2010 Ctrl Delay			101.7									
HCM 2010 LOS			F									
<b>Notes</b>												

												
Movement	EBL	EBT	EBR	WBL	WBT	WBR	NBL	NBT	NBR	SBL	SBT	SBR
Lane Configurations												
Traffic Volume (veh/h)	34	217	408	72	866	16	1107	36	85	18	52	189
Future Volume (veh/h)	34	217	408	72	866	16	1107	36	85	18	52	189
Number	1	6	16	5	2	12	3	8	18	7	4	14
Initial Q (Qb), veh	0	0	0	0	0	0	0	0	0	0	0	0
Ped-Bike Adj(A_pbT)	1.00		1.00	1.00		1.00	1.00		1.00	1.00		1.00
Parking Bus, Adj	1.00	1.00	1.00	1.00	1.00	1.00	1.00	1.00	1.00	1.00	1.00	1.00
Adj Sat Flow, veh/h/ln	1863	1810	1863	1863	1810	1863	1863	1863	1863	1863	1765	1863
Adj Flow Rate, veh/h	36	228	0	95	1139	0	1531	0	0	23	66	0
Adj No. of Lanes	1	2	1	1	2	1	2	0	1	1	1	1
Peak Hour Factor	0.95	0.95	0.95	0.76	0.76	0.76	0.74	0.74	0.74	0.79	0.79	0.79
Percent Heavy Veh, %	2	5	2	2	5	2	2	2	2	2	2	2
Cap, veh/h	54	1699	782	667	1761	811	781	0	332	111	110	83
Arrive On Green	0.03	0.49	0.00	0.05	0.51	0.00	0.22	0.00	0.00	0.06	0.06	0.00
Sat Flow, veh/h	1774	3438	1583	1774	3438	1583	3548	0	1583	1774	1765	1583
Grp Volume(v), veh/h	36	228	0	95	1139	0	1531	0	0	23	66	0
Grp Sat Flow(s),veh/h/ln	1774	1719	1583	1774	1719	1583	1774	0	1583	1774	1765	1583
Q Serve(g_s), s	2.0	3.6	0.0	2.7	24.2	0.0	22.0	0.0	0.0	1.2	3.6	0.0
Cycle Q Clear(g_c), s	2.0	3.6	0.0	2.7	24.2	0.0	22.0	0.0	0.0	1.2	3.6	0.0
Prop In Lane	1.00		1.00	1.00		1.00	1.00		1.00	1.00		1.00
Lane Grp Cap(c), veh/h	54	1699	782	667	1761	811	781	0	332	111	110	83
V/C Ratio(X)	0.67	0.13	0.00	0.14	0.65	0.00	1.96	0.00	0.00	0.21	0.60	0.00
Avail Cap(c_a), veh/h	115	1699	782	696	1761	811	781	0	332	248	247	206
HCM Platoon Ratio	1.00	1.00	1.00	1.00	1.00	1.00	1.00	1.00	1.00	1.00	1.00	1.00
Upstream Filter(I)	1.00	1.00	0.00	1.00	1.00	0.00	1.00	0.00	0.00	1.00	1.00	0.00
Uniform Delay (d), s/veh	48.0	13.7	0.0	11.9	17.8	0.0	39.0	0.0	0.0	44.5	45.7	0.0
Incr Delay (d2), s/veh	8.4	0.2	0.0	0.1	1.8	0.0	437.3	0.0	0.0	0.6	3.2	0.0
Initial Q Delay(d3),s/veh	0.0	0.0	0.0	0.0	0.0	0.0	0.0	0.0	0.0	0.0	0.0	0.0
%ile BackOfQ(50%),veh/ln	1.1	1.7	0.0	1.3	11.8	0.0	58.1	0.0	0.0	0.6	1.9	0.0
LnGrp Delay(d),s/veh	56.4	13.9	0.0	12.0	19.6	0.0	476.3	0.0	0.0	45.1	48.8	0.0
LnGrp LOS	E	B		B	B		F			D	D	
Approach Vol, veh/h		264			1234			1531			89	
Approach Delay, s/veh		19.7			19.0			476.3			47.9	
Approach LOS		B			B			F			D	
Timer	1	2	3	4	5	6	7	8				
Assigned Phs	1	2		4	5	6		8				
Phs Duration (G+Y+Rc), s	8.5	55.2		10.2	10.4	53.4		26.0				
Change Period (Y+Rc), s	6.0	6.0		5.0	6.0	6.0		5.0				
Max Green Setting (Gmax), s	6.0	38.0		13.0	6.0	38.0		21.0				
Max Q Clear Time (g_c+I1), s	4.0	26.2		5.6	4.7	5.6		24.0				
Green Ext Time (p_c), s	0.0	10.7		0.1	0.0	26.3		0.0				
<b>Intersection Summary</b>												
HCM 2010 Ctrl Delay			244.4									
HCM 2010 LOS			F									
<b>Notes</b>												

Intersection												
Int Delay, s/veh	3.1											
Movement	EBL	EBT	EBR	WBL	WBT	WBR	NBL	NBT	NBR	SBL	SBT	SBR
Lane Configurations		↑	↗		↕		↖	↑	↗	↖	↑	↗
Traffic Vol, veh/h	37	4	10	3	4	59	17	1054	2	17	430	20
Future Vol, veh/h	37	4	10	3	4	59	17	1054	2	17	430	20
Conflicting Peds, #/hr	0	0	0	0	0	0	0	0	0	0	0	0
Sign Control	Stop	Stop	Stop	Stop	Stop	Stop	Free	Free	Free	Free	Free	Free
RT Channelized	-	-	Stop	-	-	None	-	-	None	-	-	None
Storage Length	-	-	170	-	-	-	140	-	280	540	-	430
Veh in Median Storage, #	-	0	-	-	0	-	-	0	-	-	0	-
Grade, %	-	0	-	-	0	-	-	0	-	-	0	-
Peak Hour Factor	81	81	81	81	81	81	81	81	81	81	81	81
Heavy Vehicles, %	2	2	2	2	2	2	2	2	2	2	2	2
Mvmt Flow	46	5	12	4	5	73	21	1301	2	21	531	25

























Major/Minor	Minor2		Minor1		Major1		Major2					
Conflicting Flow All	1955	1916	531	1918	1916	1301	531	0	0	1301	0	0
Stage 1	573	573	-	1343	1343	-	-	-	-	-	-	-
Stage 2	1382	1343	-	575	573	-	-	-	-	-	-	-
Critical Hdwy	7.12	6.52	6.22	7.12	6.52	6.22	4.12	-	-	4.12	-	-
Critical Hdwy Stg 1	6.12	5.52	-	6.12	5.52	-	-	-	-	-	-	-
Critical Hdwy Stg 2	6.12	5.52	-	6.12	5.52	-	-	-	-	-	-	-
Follow-up Hdwy	3.518	4.018	3.318	3.518	4.018	3.318	2.218	-	-	2.218	-	-
Pot Cap-1 Maneuver	48	68	548	51	68	197	1036	-	-	532	-	-
Stage 1	505	504	-	187	221	-	-	-	-	-	-	-
Stage 2	178	221	-	503	504	-	-	-	-	-	-	-
Platoon blocked, %								-	-	-	-	-
Mov Cap-1 Maneuver	~ 27	64	548	45	64	197	1036	-	-	532	-	-
Mov Cap-2 Maneuver	~ 27	64	-	45	64	-	-	-	-	-	-	-
Stage 1	495	484	-	183	217	-	-	-	-	-	-	-
Stage 2	107	217	-	467	484	-	-	-	-	-	-	-

Approach	EB	WB	NB	SB
HCM Control Delay, s	27.2	52	0.1	0.4
HCM LOS	D	F		

























Minor Lane/Major Mvmt	NBL	NBT	NBR	EBLn1	EBLn2	WBLn1	SBL	SBT	SBR
Capacity (veh/h)	1036	-	-	64	548	154	532	-	-
HCM Lane V/C Ratio	0.02	-	-	0.077	0.023	0.529	0.039	-	-
HCM Control Delay (s)	8.5	-	-	65.9	11.7	52	12	-	-
HCM Lane LOS	A	-	-	F	B	F	B	-	-
HCM 95th %tile Q(veh)	0.1	-	-	0.2	0.1	2.6	0.1	-	-

Notes  
 ~: Volume exceeds capacity    \$: Delay exceeds 300s    +: Computation Not Defined    \*: All major volume in platoon



												
Movement	EBL	EBT	EBR	WBL	WBT	WBR	NBL	NBT	NBR	SBL	SBT	SBR
Lane Configurations												
Traffic Volume (veh/h)	170	1764	6	16	845	57	11	9	16	173	7	360
Future Volume (veh/h)	170	1764	6	16	845	57	11	9	16	173	7	360
Number	1	6	16	5	2	12	3	8	18	7	4	14
Initial Q (Qb), veh	0	0	0	0	0	0	0	0	0	0	0	0
Ped-Bike Adj(A_pbT)	1.00		1.00	1.00		1.00	1.00		1.00	1.00		1.00
Parking Bus, Adj	1.00	1.00	1.00	1.00	1.00	1.00	1.00	1.00	1.00	1.00	1.00	1.00
Adj Sat Flow, veh/h/ln	1740	1707	1740	1740	1707	1740	1740	1740	1740	1740	1740	1740
Adj Flow Rate, veh/h	200	2075	0	17	889	0	20	16	0	211	9	0
Adj No. of Lanes	2	2	1	1	2	1	1	1	1	2	1	1
Peak Hour Factor	0.85	0.85	0.85	0.95	0.95	0.95	0.56	0.56	0.56	0.82	0.82	0.82
Percent Heavy Veh, %	2	4	2	2	4	2	2	2	2	2	2	2
Cap, veh/h	442	2283	1012	27	1891	833	166	67	42	363	87	59
Arrive On Green	0.14	0.70	0.00	0.02	0.58	0.00	0.06	0.04	0.00	0.07	0.05	0.00
Sat Flow, veh/h	3215	3243	1479	1657	3243	1479	1657	1740	1479	3215	1740	1479
Grp Volume(v), veh/h	200	2075	0	17	889	0	20	16	0	211	9	0
Grp Sat Flow(s),veh/h/ln	1608	1621	1479	1657	1621	1479	1657	1740	1479	1608	1740	1479
Q Serve(g_s), s	5.7	52.6	0.0	1.0	15.7	0.0	0.0	0.9	0.0	6.5	0.5	0.0
Cycle Q Clear(g_c), s	5.7	52.6	0.0	1.0	15.7	0.0	0.0	0.9	0.0	6.5	0.5	0.0
Prop In Lane	1.00		1.00	1.00		1.00	1.00		1.00	1.00		1.00
Lane Grp Cap(c), veh/h	442	2283	1012	27	1891	833	166	67	42	363	87	59
V/C Ratio(X)	0.45	0.91	0.00	0.63	0.47	0.00	0.12	0.24	0.00	0.58	0.10	0.00
Avail Cap(c_a), veh/h	442	2283	1012	96	1891	833	185	118	86	363	118	86
HCM Platoon Ratio	1.00	1.00	1.00	1.00	1.00	1.00	1.00	1.00	1.00	1.00	1.00	1.00
Upstream Filter(I)	1.00	1.00	0.00	1.00	1.00	0.00	1.00	1.00	0.00	1.00	1.00	0.00
Uniform Delay (d), s/veh	39.7	12.2	0.0	48.9	12.0	0.0	44.5	46.6	0.0	46.4	45.4	0.0
Incr Delay (d2), s/veh	0.4	6.7	0.0	13.6	0.8	0.0	0.2	1.1	0.0	1.9	0.3	0.0
Initial Q Delay(d3),s/veh	0.0	0.0	0.0	0.0	0.0	0.0	0.0	0.0	0.0	0.0	0.0	0.0
%ile BackOfQ(50%),veh/ln	2.6	25.2	0.0	0.6	7.3	0.0	0.5	0.5	0.0	3.0	0.2	0.0
LnGrp Delay(d),s/veh	40.1	18.9	0.0	62.5	12.8	0.0	44.7	47.8	0.0	48.3	45.7	0.0
LnGrp LOS	D	B		E	B		D	D		D	D	
Approach Vol, veh/h		2275			906			36			220	
Approach Delay, s/veh		20.8			13.8			46.1			48.2	
Approach LOS		C			B			D			D	
Timer	1	2	3	4	5	6	7	8				
Assigned Phs	1	2	3	4	5	6	7	8				
Phs Duration (G+Y+Rc), s	18.9	62.0	9.9	9.2	6.8	74.1	11.0	8.1				
Change Period (Y+Rc), s	5.7	5.7	* 5.2	* 5.2	5.7	5.7	* 5.2	* 5.2				
Max Green Setting (Gmax), s	10.3	56.3	* 5.8	* 5.8	5.3	61.3	* 5.8	* 5.8				
Max Q Clear Time (g_c+I1), s	7.7	17.7	2.0	2.5	3.0	54.6	8.5	2.9				
Green Ext Time (p_c), s	0.2	4.5	0.0	0.0	0.0	5.4	0.0	0.0				
<b>Intersection Summary</b>												
HCM 2010 Ctrl Delay			20.9									
HCM 2010 LOS			C									
<b>Notes</b>												



												
Movement	EBL	EBT	EBR	WBL	WBT	WBR	NBL	NBT	NBR	SBL	SBT	SBR
Lane Configurations												
Traffic Volume (veh/h)	192	788	926	36	272	30	560	60	86	45	46	71
Future Volume (veh/h)	192	788	926	36	272	30	560	60	86	45	46	71
Number	1	6	16	5	2	12	3	8	18	7	4	14
Initial Q (Qb), veh	0	0	0	0	0	0	0	0	0	0	0	0
Ped-Bike Adj(A_pbT)	1.00		1.00	1.00		1.00	1.00		1.00	1.00		1.00
Parking Bus, Adj	1.00	1.00	1.00	1.00	1.00	1.00	1.00	1.00	1.00	1.00	1.00	1.00
Adj Sat Flow, veh/h/ln	1740	1690	1740	1740	1690	1740	1740	1740	1740	1740	1740	1740
Adj Flow Rate, veh/h	204	838	0	42	320	0	670	0	0	51	52	0
Adj No. of Lanes	1	2	1	1	2	1	2	0	1	1	1	1
Peak Hour Factor	0.94	0.94	0.94	0.85	0.85	0.85	0.90	0.90	0.90	0.88	0.88	0.88
Percent Heavy Veh, %	2	5	2	2	5	2	2	2	2	2	2	2
Cap, veh/h	614	1620	746	60	1463	674	753	0	321	95	100	70
Arrive On Green	0.09	0.50	0.00	0.04	0.46	0.00	0.23	0.00	0.00	0.06	0.06	0.00
Sat Flow, veh/h	1657	3212	1479	1657	3212	1479	3315	0	1479	1657	1740	1479
Grp Volume(v), veh/h	204	838	0	42	320	0	670	0	0	51	52	0
Grp Sat Flow(s),veh/h/ln	1657	1606	1479	1657	1606	1479	1657	0	1479	1657	1740	1479
Q Serve(g_s), s	6.5	17.5	0.0	2.5	6.0	0.0	19.6	0.0	0.0	3.0	2.9	0.0
Cycle Q Clear(g_c), s	6.5	17.5	0.0	2.5	6.0	0.0	19.6	0.0	0.0	3.0	2.9	0.0
Prop In Lane	1.00		1.00	1.00		1.00	1.00		1.00	1.00		1.00
Lane Grp Cap(c), veh/h	614	1620	746	60	1463	674	753	0	321	95	100	70
V/C Ratio(X)	0.33	0.52	0.00	0.70	0.22	0.00	0.89	0.00	0.00	0.54	0.52	0.00
Avail Cap(c_a), veh/h	614	1620	746	141	1463	674	762	0	325	149	157	118
HCM Platoon Ratio	1.00	1.00	1.00	1.00	1.00	1.00	1.00	1.00	1.00	1.00	1.00	1.00
Upstream Filter(I)	1.00	1.00	0.00	1.00	1.00	0.00	1.00	0.00	0.00	1.00	1.00	0.00
Uniform Delay (d), s/veh	12.4	16.6	0.0	47.7	16.5	0.0	37.4	0.0	0.0	45.8	45.8	0.0
Incr Delay (d2), s/veh	0.2	1.2	0.0	8.8	0.3	0.0	12.3	0.0	0.0	2.8	2.5	0.0
Initial Q Delay(d3),s/veh	0.0	0.0	0.0	0.0	0.0	0.0	0.0	0.0	0.0	0.0	0.0	0.0
%ile BackOfQ(50%),veh/ln	2.9	7.9	0.0	1.3	2.7	0.0	10.2	0.0	0.0	1.4	1.5	0.0
LnGrp Delay(d),s/veh	12.6	17.8	0.0	56.4	16.8	0.0	49.7	0.0	0.0	48.7	48.3	0.0
LnGrp LOS	B	B		E	B		D			D	D	
Approach Vol, veh/h		1042			362			670			103	
Approach Delay, s/veh		16.8			21.4			49.7			48.5	
Approach LOS		B			C			D			D	
Timer	1	2	3	4	5	6	7	8				
Assigned Phs	1	2		4	5	6		8				
Phs Duration (G+Y+Rc), s	14.0	49.5		9.7	9.1	54.4		26.7				
Change Period (Y+Rc), s	6.0	6.0		5.0	6.0	6.0		5.0				
Max Green Setting (Gmax), s	8.0	40.0		8.0	8.0	40.0		22.0				
Max Q Clear Time (g_c+I1), s	8.5	8.0		5.0	4.5	19.5		21.6				
Green Ext Time (p_c), s	0.0	22.0		0.0	0.0	15.6		0.1				
<b>Intersection Summary</b>												
HCM 2010 Ctrl Delay			29.2									
HCM 2010 LOS			C									
<b>Notes</b>												

Intersection												
Int Delay, s/veh	1.4											
Movement	EBL	EBT	EBR	WBL	WBT	WBR	NBL	NBT	NBR	SBL	SBT	SBR
Lane Configurations		↑	↗		↕		↖	↑	↗	↖	↑	↗
Traffic Vol, veh/h	18	2	37	4	4	24	17	592	4	33	563	31
Future Vol, veh/h	18	2	37	4	4	24	17	592	4	33	563	31
Conflicting Peds, #/hr	0	0	0	0	0	0	0	0	0	0	0	0
Sign Control	Stop	Stop	Stop	Stop	Stop	Stop	Free	Free	Free	Free	Free	Free
RT Channelized	-	-	Stop	-	-	None	-	-	None	-	-	None
Storage Length	-	-	170	-	-	-	140	-	280	540	-	430
Veh in Median Storage, #	-	0	-	-	0	-	-	0	-	-	0	-
Grade, %	-	0	-	-	0	-	-	0	-	-	0	-
Peak Hour Factor	94	94	94	94	94	94	94	94	94	94	94	94
Heavy Vehicles, %	2	2	2	2	2	2	2	2	2	2	2	2
Mvmt Flow	19	2	39	4	4	26	18	630	4	35	599	33

























Major/Minor	Minor2		Minor1		Major1		Major2					
Conflicting Flow All	1350	1335	599	1336	1335	630	599	0	0	630	0	0
Stage 1	669	669	-	666	666	-	-	-	-	-	-	-
Stage 2	681	666	-	670	669	-	-	-	-	-	-	-
Critical Hdwy	7.12	6.52	6.22	7.12	6.52	6.22	4.12	-	-	4.12	-	-
Critical Hdwy Stg 1	6.12	5.52	-	6.12	5.52	-	-	-	-	-	-	-
Critical Hdwy Stg 2	6.12	5.52	-	6.12	5.52	-	-	-	-	-	-	-
Follow-up Hdwy	3.518	4.018	3.318	3.518	4.018	3.318	2.218	-	-	2.218	-	-
Pot Cap-1 Maneuver	128	154	502	130	154	482	978	-	-	952	-	-
Stage 1	447	456	-	449	457	-	-	-	-	-	-	-
Stage 2	440	457	-	446	456	-	-	-	-	-	-	-
Platoon blocked, %								-	-	-	-	-
Mov Cap-1 Maneuver	114	146	502	114	146	482	978	-	-	952	-	-
Mov Cap-2 Maneuver	114	146	-	114	146	-	-	-	-	-	-	-
Stage 1	439	439	-	441	449	-	-	-	-	-	-	-
Stage 2	405	449	-	394	439	-	-	-	-	-	-	-

























Approach	EB	WB	NB	SB
HCM Control Delay, s	13.7	19.3	0.2	0.5
HCM LOS	B	C		

Minor Lane/Major Mvmt	NBL	NBT	NBR	EBLn1	EBLn2	WBLn1	SBL	SBT	SBR
Capacity (veh/h)	978	-	-	146	502	285	952	-	-
HCM Lane V/C Ratio	0.018	-	-	0.015	0.078	0.119	0.037	-	-
HCM Control Delay (s)	8.8	-	-	30	12.8	19.3	8.9	-	-
HCM Lane LOS	A	-	-	D	B	C	A	-	-
HCM 95th %tile Q(veh)	0.1	-	-	0	0.3	0.4	0.1	-	-

HCM 2010 Signalized Intersection Summary  
4: Three Springs Road & US 160

Existing Summer AM (220 Closure)  
01/09/2019

												
Movement	EBL	EBT	EBR	WBL	WBT	WBR	NBL	NBT	NBR	SBL	SBT	SBR
Lane Configurations												
Traffic Volume (veh/h)	420	499	2	28	1611	268	30	9	12	60	3	151
Future Volume (veh/h)	420	499	2	28	1611	268	30	9	12	60	3	151
Number	1	6	16	5	2	12	3	8	18	7	4	14
Initial Q (Qb), veh	0	0	0	0	0	0	0	0	0	0	0	0
Ped-Bike Adj(A_pbT)	1.00		1.00	1.00		1.00	1.00		1.00	1.00		1.00
Parking Bus, Adj	1.00	1.00	1.00	1.00	1.00	1.00	1.00	1.00	1.00	1.00	1.00	1.00
Adj Sat Flow, veh/h/ln	1740	1707	1740	1740	1707	1740	1740	1740	1740	1740	1740	1740
Adj Flow Rate, veh/h	488	580	0	36	2092	0	43	13	0	78	4	0
Adj No. of Lanes	2	2	1	1	2	1	1	1	1	2	1	1
Peak Hour Factor	0.86	0.86	0.86	0.77	0.77	0.77	0.69	0.69	0.69	0.77	0.77	0.77
Percent Heavy Veh, %	2	4	2	2	4	2	2	2	2	2	2	2
Cap, veh/h	563	2324	1031	52	1858	818	181	74	48	357	82	55
Arrive On Green	0.17	0.72	0.00	0.03	0.57	0.00	0.03	0.04	0.00	0.04	0.05	0.00
Sat Flow, veh/h	3215	3243	1479	1657	3243	1479	1657	1740	1479	3215	1740	1479
Grp Volume(v), veh/h	488	580	0	36	2092	0	43	13	0	78	4	0
Grp Sat Flow(s),veh/h/ln	1608	1621	1479	1657	1621	1479	1657	1740	1479	1608	1740	1479
Q Serve(g_s), s	14.8	6.2	0.0	2.2	57.3	0.0	0.0	0.7	0.0	0.0	0.2	0.0
Cycle Q Clear(g_c), s	14.8	6.2	0.0	2.2	57.3	0.0	0.0	0.7	0.0	0.0	0.2	0.0
Prop In Lane	1.00		1.00	1.00		1.00	1.00		1.00	1.00		1.00
Lane Grp Cap(c), veh/h	563	2324	1031	52	1858	818	181	74	48	357	82	55
V/C Ratio(X)	0.87	0.25	0.00	0.69	1.13	0.00	0.24	0.18	0.00	0.22	0.05	0.00
Avail Cap(c_a), veh/h	563	2324	1031	96	1858	818	241	118	86	458	118	86
HCM Platoon Ratio	1.00	1.00	1.00	1.00	1.00	1.00	1.00	1.00	1.00	1.00	1.00	1.00
Upstream Filter(I)	1.00	1.00	0.00	1.00	1.00	0.00	1.00	1.00	0.00	1.00	1.00	0.00
Uniform Delay (d), s/veh	40.1	4.9	0.0	48.0	21.4	0.0	44.4	46.2	0.0	44.4	45.5	0.0
Incr Delay (d2), s/veh	13.2	0.3	0.0	9.8	64.3	0.0	0.4	0.7	0.0	0.2	0.1	0.0
Initial Q Delay(d3),s/veh	0.0	0.0	0.0	0.0	0.0	0.0	0.0	0.0	0.0	0.0	0.0	0.0
%ile BackOfQ(50%),veh/ln	7.6	2.8	0.0	1.1	41.9	0.0	1.2	0.4	0.0	1.0	0.1	0.0
LnGrp Delay(d),s/veh	53.3	5.1	0.0	57.7	85.6	0.0	44.8	46.9	0.0	44.5	45.6	0.0
LnGrp LOS	D	A		E	F		D	D		D	D	
Approach Vol, veh/h		1068			2128			56			82	
Approach Delay, s/veh		27.2			85.2			45.3			44.6	
Approach LOS		C			F			D			D	
Timer	1	2	3	4	5	6	7	8				
Assigned Phs	1	2	3	4	5	6	7	8				
Phs Duration (G+Y+Rc), s	22.7	61.0	7.4	8.9	8.3	75.4	7.9	8.4				
Change Period (Y+Rc), s	5.7	5.7	* 5.2	* 5.2	5.7	5.7	* 5.2	* 5.2				
Max Green Setting (Gmax), s	11.3	55.3	* 5.8	* 5.8	5.3	61.3	* 5.8	* 5.8				
Max Q Clear Time (g_c+1), s	16.8	59.3	2.0	2.2	4.2	8.2	2.0	2.7				
Green Ext Time (p_c), s	0.0	0.0	0.1	0.0	0.0	4.2	0.1	0.0				
<b>Intersection Summary</b>												
HCM 2010 Ctrl Delay			64.9									
HCM 2010 LOS			E									
<b>Notes</b>												

												
Movement	EBL	EBT	EBR	WBL	WBT	WBR	NBL	NBT	NBR	SBL	SBT	SBR
Lane Configurations												
Traffic Volume (veh/h)	39	251	251	83	997	18	661	41	39	21	60	217
Future Volume (veh/h)	39	251	251	83	997	18	661	41	39	21	60	217
Number	1	6	16	5	2	12	3	8	18	7	4	14
Initial Q (Qb), veh	0	0	0	0	0	0	0	0	0	0	0	0
Ped-Bike Adj(A_pbT)	1.00		1.00	1.00		1.00	1.00		1.00	1.00		1.00
Parking Bus, Adj	1.00	1.00	1.00	1.00	1.00	1.00	1.00	1.00	1.00	1.00	1.00	1.00
Adj Sat Flow, veh/h/ln	1740	1690	1740	1740	1690	1740	1740	1740	1740	1740	1740	1740
Adj Flow Rate, veh/h	41	264	0	109	1312	0	932	0	0	27	76	0
Adj No. of Lanes	1	2	1	1	2	1	2	0	1	1	1	1
Peak Hour Factor	0.95	0.95	0.95	0.76	0.76	0.76	0.74	0.74	0.74	0.79	0.79	0.79
Percent Heavy Veh, %	2	5	2	2	5	2	2	2	2	2	2	2
Cap, veh/h	58	1538	708	629	1606	740	729	0	311	116	121	88
Arrive On Green	0.04	0.48	0.00	0.06	0.50	0.00	0.22	0.00	0.00	0.07	0.07	0.00
Sat Flow, veh/h	1657	3212	1479	1657	3212	1479	3315	0	1479	1657	1740	1479
Grp Volume(v), veh/h	41	264	0	109	1312	0	932	0	0	27	76	0
Grp Sat Flow(s),veh/h/ln	1657	1606	1479	1657	1606	1479	1657	0	1479	1657	1740	1479
Q Serve(g_s), s	2.4	4.7	0.0	3.4	34.5	0.0	22.0	0.0	0.0	1.5	4.2	0.0
Cycle Q Clear(g_c), s	2.4	4.7	0.0	3.4	34.5	0.0	22.0	0.0	0.0	1.5	4.2	0.0
Prop In Lane	1.00		1.00	1.00		1.00	1.00		1.00	1.00		1.00
Lane Grp Cap(c), veh/h	58	1538	708	629	1606	740	729	0	311	116	121	88
V/C Ratio(X)	0.70	0.17	0.00	0.17	0.82	0.00	1.28	0.00	0.00	0.23	0.63	0.00
Avail Cap(c_a), veh/h	108	1538	708	643	1606	740	729	0	311	232	244	192
HCM Platoon Ratio	1.00	1.00	1.00	1.00	1.00	1.00	1.00	1.00	1.00	1.00	1.00	1.00
Upstream Filter(I)	1.00	1.00	0.00	1.00	1.00	0.00	1.00	0.00	0.00	1.00	1.00	0.00
Uniform Delay (d), s/veh	47.7	14.8	0.0	12.4	21.1	0.0	39.0	0.0	0.0	44.0	45.2	0.0
Incr Delay (d2), s/veh	9.0	0.2	0.0	0.1	4.7	0.0	135.6	0.0	0.0	0.6	3.2	0.0
Initial Q Delay(d3),s/veh	0.0	0.0	0.0	0.0	0.0	0.0	0.0	0.0	0.0	0.0	0.0	0.0
%ile BackOfQ(50%),veh/ln	1.3	2.1	0.0	1.5	16.4	0.0	23.8	0.0	0.0	0.7	2.2	0.0
LnGrp Delay(d),s/veh	56.7	15.0	0.0	12.6	25.9	0.0	174.6	0.0	0.0	44.6	48.5	0.0
LnGrp LOS	E	B		B	C		F			D	D	
Approach Vol, veh/h		305			1421			932			103	
Approach Delay, s/veh		20.6			24.8			174.6			47.5	
Approach LOS		C			C			F			D	
Timer	1	2	3	4	5	6	7	8				
Assigned Phs	1	2		4	5	6		8				
Phs Duration (G+Y+Rc), s	9.0	54.0		11.0	11.1	51.9		26.0				
Change Period (Y+Rc), s	6.0	6.0		5.0	6.0	6.0		5.0				
Max Green Setting (Gmax), s	6.0	38.0		13.0	6.0	38.0		21.0				
Max Q Clear Time (g_c+1), s	4.4	36.5		6.2	5.4	6.7		24.0				
Green Ext Time (p_c), s	0.0	1.4		0.1	0.0	27.6		0.0				
<b>Intersection Summary</b>												
HCM 2010 Ctrl Delay				75.8								
HCM 2010 LOS				E								
<b>Notes</b>												

Intersection												
Int Delay, s/veh	2.2											
Movement	EBL	EBT	EBR	WBL	WBT	WBR	NBL	NBT	NBR	SBL	SBT	SBR
Lane Configurations		↑	↗		↕		↖	↑	↗	↖	↑	↗
Traffic Vol, veh/h	43	5	12	3	5	68	20	542	2	20	276	23
Future Vol, veh/h	43	5	12	3	5	68	20	542	2	20	276	23
Conflicting Peds, #/hr	0	0	0	0	0	0	0	0	0	0	0	0
Sign Control	Stop	Stop	Stop	Stop	Stop	Stop	Free	Free	Free	Free	Free	Free
RT Channelized	-	-	Stop	-	-	None	-	-	None	-	-	None
Storage Length	-	-	170	-	-	-	140	-	280	540	-	430
Veh in Median Storage, #	-	0	-	-	0	-	-	0	-	-	0	-
Grade, %	-	0	-	-	0	-	-	0	-	-	0	-
Peak Hour Factor	94	94	94	94	94	94	94	94	94	94	94	94
Heavy Vehicles, %	2	2	2	2	2	2	2	2	2	2	2	2
Mvmt Flow	46	5	13	3	5	72	21	577	2	21	294	24

























Major/Minor	Minor2		Minor1		Major1		Major2					
Conflicting Flow All	994	955	294	958	955	577	294	0	0	577	0	0
Stage 1	336	336	-	619	619	-	-	-	-	-	-	-
Stage 2	658	619	-	339	336	-	-	-	-	-	-	-
Critical Hdwy	7.12	6.52	6.22	7.12	6.52	6.22	4.12	-	-	4.12	-	-
Critical Hdwy Stg 1	6.12	5.52	-	6.12	5.52	-	-	-	-	-	-	-
Critical Hdwy Stg 2	6.12	5.52	-	6.12	5.52	-	-	-	-	-	-	-
Follow-up Hdwy	3.518	4.018	3.318	3.518	4.018	3.318	2.218	-	-	2.218	-	-
Pot Cap-1 Maneuver	224	258	745	237	258	516	1268	-	-	996	-	-
Stage 1	678	642	-	476	480	-	-	-	-	-	-	-
Stage 2	453	480	-	676	642	-	-	-	-	-	-	-
Platoon blocked, %								-	-	-	-	-
Mov Cap-1 Maneuver	184	248	745	223	248	516	1268	-	-	996	-	-
Mov Cap-2 Maneuver	184	248	-	223	248	-	-	-	-	-	-	-
Stage 1	667	628	-	468	472	-	-	-	-	-	-	-
Stage 2	379	472	-	645	628	-	-	-	-	-	-	-

























Approach	EB		WB		NB		SB	
HCM Control Delay, s	12.8		14.5		0.3		0.5	
HCM LOS	B		B					

Minor Lane/Major Mvmt	NBL	NBT	NBR	EBLn1	EBLn2	WBLn1	SBL	SBT	SBR
Capacity (veh/h)	1268	-	-	248	745	460	996	-	-
HCM Lane V/C Ratio	0.017	-	-	0.021	0.017	0.176	0.021	-	-
HCM Control Delay (s)	7.9	-	-	19.8	9.9	14.5	8.7	-	-
HCM Lane LOS	A	-	-	C	A	B	A	-	-
HCM 95th %tile Q(veh)	0.1	-	-	0.1	0.1	0.6	0.1	-	-

HCM 2010 Signalized Intersection Summary  
4: Three Springs Road & US 160

Existing Summer PM (220 Closure)  
01/09/2019

												
Movement	EBL	EBT	EBR	WBL	WBT	WBR	NBL	NBT	NBR	SBL	SBT	SBR
Lane Configurations												
Traffic Volume (veh/h)	196	1379	7	18	743	66	13	10	18	199	8	414
Future Volume (veh/h)	196	1379	7	18	743	66	13	10	18	199	8	414
Number	1	6	16	5	2	12	3	8	18	7	4	14
Initial Q (Qb), veh	0	0	0	0	0	0	0	0	0	0	0	0
Ped-Bike Adj(A_pbT)	1.00		1.00	1.00		1.00	1.00		1.00	1.00		1.00
Parking Bus, Adj	1.00	1.00	1.00	1.00	1.00	1.00	1.00	1.00	1.00	1.00	1.00	1.00
Adj Sat Flow, veh/h/ln	1740	1707	1740	1740	1707	1740	1740	1740	1740	1740	1740	1740
Adj Flow Rate, veh/h	231	1622	0	19	782	0	23	18	0	243	10	0
Adj No. of Lanes	2	2	1	1	2	1	1	1	1	2	1	1
Peak Hour Factor	0.85	0.85	0.85	0.95	0.95	0.95	0.56	0.56	0.56	0.82	0.82	0.82
Percent Heavy Veh, %	2	4	2	2	4	2	2	2	2	2	2	2
Cap, veh/h	436	2273	1007	30	1891	833	169	70	45	363	87	59
Arrive On Green	0.14	0.70	0.00	0.02	0.58	0.00	0.06	0.04	0.00	0.07	0.05	0.00
Sat Flow, veh/h	3215	3243	1479	1657	3243	1479	1657	1740	1479	3215	1740	1479
Grp Volume(v), veh/h	231	1622	0	19	782	0	23	18	0	243	10	0
Grp Sat Flow(s),veh/h/ln	1608	1621	1479	1657	1621	1479	1657	1740	1479	1608	1740	1479
Q Serve(g_s), s	6.7	29.9	0.0	1.1	13.3	0.0	0.0	1.0	0.0	6.8	0.5	0.0
Cycle Q Clear(g_c), s	6.7	29.9	0.0	1.1	13.3	0.0	0.0	1.0	0.0	6.8	0.5	0.0
Prop In Lane	1.00		1.00	1.00		1.00	1.00		1.00	1.00		1.00
Lane Grp Cap(c), veh/h	436	2273	1007	30	1891	833	169	70	45	363	87	59
V/C Ratio(X)	0.53	0.71	0.00	0.64	0.41	0.00	0.14	0.26	0.00	0.67	0.11	0.00
Avail Cap(c_a), veh/h	436	2273	1007	96	1891	833	185	118	86	363	118	86
HCM Platoon Ratio	1.00	1.00	1.00	1.00	1.00	1.00	1.00	1.00	1.00	1.00	1.00	1.00
Upstream Filter(I)	1.00	1.00	0.00	1.00	1.00	0.00	1.00	1.00	0.00	1.00	1.00	0.00
Uniform Delay (d), s/veh	40.2	9.0	0.0	48.8	11.5	0.0	44.3	46.5	0.0	46.9	45.4	0.0
Incr Delay (d2), s/veh	0.8	1.9	0.0	13.2	0.7	0.0	0.2	1.2	0.0	4.2	0.4	0.0
Initial Q Delay(d3),s/veh	0.0	0.0	0.0	0.0	0.0	0.0	0.0	0.0	0.0	0.0	0.0	0.0
%ile BackOfQ(50%),veh/ln	3.0	13.9	0.0	0.6	6.0	0.0	0.6	0.5	0.0	0.5	0.3	0.0
LnGrp Delay(d),s/veh	41.1	10.9	0.0	62.0	12.1	0.0	44.6	47.7	0.0	51.0	45.7	0.0
LnGrp LOS	D	B		E	B		D	D		D	D	
Approach Vol, veh/h		1853			801			41			253	
Approach Delay, s/veh		14.7			13.3			45.9			50.8	
Approach LOS		B			B			D			D	
Timer	1	2	3	4	5	6	7	8				
Assigned Phs	1	2	3	4	5	6	7	8				
Phs Duration (G+Y+Rc), s	18.8	62.0	10.0	9.2	7.0	73.8	11.0	8.2				
Change Period (Y+Rc), s	5.7	5.7	* 5.2	* 5.2	5.7	5.7	* 5.2	* 5.2				
Max Green Setting (Gmax), s	10.3	56.3	* 5.8	* 5.8	5.3	61.3	* 5.8	* 5.8				
Max Q Clear Time (g_c+I1), s	8.7	15.3	2.0	2.5	3.1	31.9	8.8	3.0				
Green Ext Time (p_c), s	0.1	3.8	0.0	0.0	0.0	11.4	0.0	0.0				
<b>Intersection Summary</b>												
HCM 2010 Ctrl Delay			17.8									
HCM 2010 LOS			B									
<b>Notes</b>												

												
Movement	EBL	EBT	EBR	WBL	WBT	WBR	NBL	NBT	NBR	SBL	SBT	SBR
Lane Configurations												
Traffic Volume (veh/h)	221	906	486	41	313	35	380	69	63	52	53	82
Future Volume (veh/h)	221	906	486	41	313	35	380	69	63	52	53	82
Number	1	6	16	5	2	12	3	8	18	7	4	14
Initial Q (Qb), veh	0	0	0	0	0	0	0	0	0	0	0	0
Ped-Bike Adj(A_pbT)	1.00		1.00	1.00		1.00	1.00		1.00	1.00		1.00
Parking Bus, Adj	1.00	1.00	1.00	1.00	1.00	1.00	1.00	1.00	1.00	1.00	1.00	1.00
Adj Sat Flow, veh/h/ln	1740	1690	1740	1740	1690	1740	1740	1740	1740	1740	1740	1740
Adj Flow Rate, veh/h	235	964	0	48	368	0	477	0	0	59	60	0
Adj No. of Lanes	1	2	1	1	2	1	2	0	1	1	1	1
Peak Hour Factor	0.94	0.94	0.94	0.85	0.85	0.85	0.90	0.90	0.90	0.88	0.88	0.88
Percent Heavy Veh, %	2	5	2	2	5	2	2	2	2	2	2	2
Cap, veh/h	637	1748	805	68	1606	740	586	0	247	105	110	78
Arrive On Green	0.09	0.54	0.00	0.04	0.50	0.00	0.18	0.00	0.00	0.06	0.06	0.00
Sat Flow, veh/h	1657	3212	1479	1657	3212	1479	3315	0	1479	1657	1740	1479
Grp Volume(v), veh/h	235	964	0	48	368	0	477	0	0	59	60	0
Grp Sat Flow(s),veh/h/ln	1657	1606	1479	1657	1606	1479	1657	0	1479	1657	1740	1479
Q Serve(g_s), s	7.0	19.5	0.0	2.9	6.5	0.0	13.8	0.0	0.0	3.5	3.3	0.0
Cycle Q Clear(g_c), s	7.0	19.5	0.0	2.9	6.5	0.0	13.8	0.0	0.0	3.5	3.3	0.0
Prop In Lane	1.00		1.00	1.00		1.00	1.00		1.00	1.00		1.00
Lane Grp Cap(c), veh/h	637	1748	805	68	1606	740	586	0	247	105	110	78
V/C Ratio(X)	0.37	0.55	0.00	0.71	0.23	0.00	0.81	0.00	0.00	0.56	0.55	0.00
Avail Cap(c_a), veh/h	637	1748	805	141	1606	740	762	0	325	149	157	118
HCM Platoon Ratio	1.00	1.00	1.00	1.00	1.00	1.00	1.00	1.00	1.00	1.00	1.00	1.00
Upstream Filter(I)	1.00	1.00	0.00	1.00	1.00	0.00	1.00	0.00	0.00	1.00	1.00	0.00
Uniform Delay (d), s/veh	10.7	14.8	0.0	47.4	14.1	0.0	39.6	0.0	0.0	45.5	45.5	0.0
Incr Delay (d2), s/veh	0.2	1.3	0.0	8.0	0.3	0.0	4.5	0.0	0.0	2.9	2.6	0.0
Initial Q Delay(d3),s/veh	0.0	0.0	0.0	0.0	0.0	0.0	0.0	0.0	0.0	0.0	0.0	0.0
%ile BackOfQ(50%),veh/ln	3.2	8.9	0.0	1.5	2.9	0.0	6.7	0.0	0.0	1.7	1.7	0.0
LnGrp Delay(d),s/veh	10.9	16.1	0.0	55.4	14.4	0.0	44.0	0.0	0.0	48.4	48.0	0.0
LnGrp LOS	B	B		E	B		D			D	D	
Approach Vol, veh/h		1199			416			477			119	
Approach Delay, s/veh		15.1			19.2			44.0			48.2	
Approach LOS		B			B			D			D	
Timer	1	2	3	4	5	6	7	8				
Assigned Phs	1	2		4	5	6		8				
Phs Duration (G+Y+Rc), s	14.0	54.0		10.3	9.6	58.4		21.7				
Change Period (Y+Rc), s	6.0	6.0		5.0	6.0	6.0		5.0				
Max Green Setting (Gmax), s	8.0	40.0		8.0	8.0	40.0		22.0				
Max Q Clear Time (g_c+I1), s	9.0	8.5		5.5	4.9	21.5		15.8				
Green Ext Time (p_c), s	0.0	24.3		0.0	0.0	15.5		0.8				
<b>Intersection Summary</b>												
HCM 2010 Ctrl Delay			23.9									
HCM 2010 LOS			C									
<b>Notes</b>												

Intersection												
Int Delay, s/veh	1.8											
Movement	EBL	EBT	EBR	WBL	WBT	WBR	NBL	NBT	NBR	SBL	SBT	SBR
Lane Configurations		↑	↗		↕		↖	↑	↗	↖	↑	↗
Traffic Vol, veh/h	21	2	43	5	5	28	20	381	5	38	407	36
Future Vol, veh/h	21	2	43	5	5	28	20	381	5	38	407	36
Conflicting Peds, #/hr	0	0	0	0	0	0	0	0	0	0	0	0
Sign Control	Stop	Stop	Stop	Stop	Stop	Stop	Free	Free	Free	Free	Free	Free
RT Channelized	-	-	Stop	-	-	None	-	-	None	-	-	None
Storage Length	-	-	170	-	-	-	140	-	280	540	-	430
Veh in Median Storage, #	-	0	-	-	0	-	-	0	-	-	0	-
Grade, %	-	0	-	-	0	-	-	0	-	-	0	-
Peak Hour Factor	94	94	94	94	94	94	94	94	94	94	94	94
Heavy Vehicles, %	2	2	2	2	2	2	2	2	2	2	2	2
Mvmt Flow	22	2	46	5	5	30	21	405	5	40	433	38

Major/Minor	Minor2		Minor1		Major1		Major2					
Conflicting Flow All	979	962	433	963	962	405	433	0	0	405	0	0
Stage 1	514	514	-	448	448	-	-	-	-	-	-	-
Stage 2	465	448	-	515	514	-	-	-	-	-	-	-
Critical Hdwy	7.12	6.52	6.22	7.12	6.52	6.22	4.12	-	-	4.12	-	-
Critical Hdwy Stg 1	6.12	5.52	-	6.12	5.52	-	-	-	-	-	-	-
Critical Hdwy Stg 2	6.12	5.52	-	6.12	5.52	-	-	-	-	-	-	-
Follow-up Hdwy	3.518	4.018	3.318	3.518	4.018	3.318	2.218	-	-	2.218	-	-
Pot Cap-1 Maneuver	229	256	623	235	256	646	1127	-	-	1154	-	-
Stage 1	543	535	-	590	573	-	-	-	-	-	-	-
Stage 2	578	573	-	543	535	-	-	-	-	-	-	-
Platoon blocked, %								-	-	-	-	-
Mov Cap-1 Maneuver	206	243	623	208	243	646	1127	-	-	1154	-	-
Mov Cap-2 Maneuver	206	243	-	208	243	-	-	-	-	-	-	-
Stage 1	533	516	-	579	562	-	-	-	-	-	-	-
Stage 2	536	562	-	484	516	-	-	-	-	-	-	-

























Approach	EB		WB		NB		SB	
HCM Control Delay, s	11.6		14.2		0.4		0.7	
HCM LOS	B		B					

























Minor Lane/Major Mvmt	NBL	NBT	NBR	EBLn1	EBLn2	WBLn1	SBL	SBT	SBR
Capacity (veh/h)	1127	-	-	243	623	432	1154	-	-
HCM Lane V/C Ratio	0.019	-	-	0.009	0.073	0.094	0.035	-	-
HCM Control Delay (s)	8.3	-	-	19.9	11.2	14.2	8.2	-	-
HCM Lane LOS	A	-	-	C	B	B	A	-	-
HCM 95th %tile Q(veh)	0.1	-	-	0	0.2	0.3	0.1	-	-



HCM 2010 Signalized Intersection Summary  
4: Three Springs Road & US 160

Existing Winter AM (220 Closure)  
01/09/2019

												
Movement	EBL	EBT	EBR	WBL	WBT	WBR	NBL	NBT	NBR	SBL	SBT	SBR
Lane Configurations												
Traffic Volume (veh/h)	364	434	2	24	1412	233	26	8	10	52	3	130
Future Volume (veh/h)	364	434	2	24	1412	233	26	8	10	52	3	130
Number	1	6	16	5	2	12	3	8	18	7	4	14
Initial Q (Qb), veh	0	0	0	0	0	0	0	0	0	0	0	0
Ped-Bike Adj(A_pbT)	1.00		1.00	1.00		1.00	1.00		1.00	1.00		1.00
Parking Bus, Adj	1.00	1.00	1.00	1.00	1.00	1.00	1.00	1.00	1.00	1.00	1.00	1.00
Adj Sat Flow, veh/h/ln	1740	1707	1740	1740	1707	1740	1740	1740	1740	1740	1740	1740
Adj Flow Rate, veh/h	423	505	0	31	1834	0	38	12	0	68	4	0
Adj No. of Lanes	2	2	1	1	2	1	1	1	1	2	1	1
Peak Hour Factor	0.86	0.86	0.86	0.77	0.77	0.77	0.69	0.69	0.69	0.77	0.77	0.77
Percent Heavy Veh, %	2	4	2	2	4	2	2	2	2	2	2	2
Cap, veh/h	571	2345	1040	45	1858	818	177	71	46	351	80	53
Arrive On Green	0.18	0.72	0.00	0.03	0.57	0.00	0.03	0.04	0.00	0.04	0.05	0.00
Sat Flow, veh/h	3215	3243	1479	1657	3243	1479	1657	1740	1479	3215	1740	1479
Grp Volume(v), veh/h	423	505	0	31	1834	0	38	12	0	68	4	0
Grp Sat Flow(s),veh/h/ln	1608	1621	1479	1657	1621	1479	1657	1740	1479	1608	1740	1479
Q Serve(g_s), s	12.5	5.1	0.0	1.9	55.6	0.0	0.0	0.7	0.0	0.0	0.2	0.0
Cycle Q Clear(g_c), s	12.5	5.1	0.0	1.9	55.6	0.0	0.0	0.7	0.0	0.0	0.2	0.0
Prop In Lane	1.00		1.00	1.00		1.00	1.00		1.00	1.00		1.00
Lane Grp Cap(c), veh/h	571	2345	1040	45	1858	818	177	71	46	351	80	53
V/C Ratio(X)	0.74	0.22	0.00	0.69	0.99	0.00	0.21	0.17	0.00	0.19	0.05	0.00
Avail Cap(c_a), veh/h	571	2345	1040	96	1858	818	239	118	86	456	118	86
HCM Platoon Ratio	1.00	1.00	1.00	1.00	1.00	1.00	1.00	1.00	1.00	1.00	1.00	1.00
Upstream Filter(I)	1.00	1.00	0.00	1.00	1.00	0.00	1.00	1.00	0.00	1.00	1.00	0.00
Uniform Delay (d), s/veh	39.0	4.5	0.0	48.2	21.0	0.0	44.5	46.3	0.0	44.4	45.6	0.0
Incr Delay (d2), s/veh	4.8	0.2	0.0	10.7	18.0	0.0	0.4	0.7	0.0	0.2	0.2	0.0
Initial Q Delay(d3),s/veh	0.0	0.0	0.0	0.0	0.0	0.0	0.0	0.0	0.0	0.0	0.0	0.0
%ile BackOfQ(50%),veh/ln	5.9	2.3	0.0	1.0	29.1	0.0	1.0	0.3	0.0	0.9	0.1	0.0
LnGrp Delay(d),s/veh	43.7	4.7	0.0	58.9	39.0	0.0	44.9	47.0	0.0	44.5	45.8	0.0
LnGrp LOS	D	A		E	D		D	D		D	D	
Approach Vol, veh/h		928			1865			50			72	
Approach Delay, s/veh		22.5			39.3			45.4			44.6	
Approach LOS		C			D			D			D	
Timer	1	2	3	4	5	6	7	8				
Assigned Phs	1	2	3	4	5	6	7	8				
Phs Duration (G+Y+Rc), s	22.9	61.0	7.2	8.8	7.9	76.0	7.7	8.3				
Change Period (Y+Rc), s	5.7	5.7	* 5.2	* 5.2	5.7	5.7	* 5.2	* 5.2				
Max Green Setting (Gmax), s	11.3	55.3	* 5.8	* 5.8	5.3	61.3	* 5.8	* 5.8				
Max Q Clear Time (g_c+I1), s	14.5	57.6	2.0	2.2	3.9	7.1	2.0	2.7				
Green Ext Time (p_c), s	0.0	0.0	0.1	0.0	0.0	3.5	0.1	0.0				
<b>Intersection Summary</b>												
HCM 2010 Ctrl Delay			34.2									
HCM 2010 LOS			C									
<b>Notes</b>												

												
Movement	EBL	EBT	EBR	WBL	WBT	WBR	NBL	NBT	NBR	SBL	SBT	SBR
Lane Configurations												
Traffic Volume (veh/h)	34	217	218	72	866	16	586	36	34	18	52	189
Future Volume (veh/h)	34	217	218	72	866	16	586	36	34	18	52	189
Number	1	6	16	5	2	12	3	8	18	7	4	14
Initial Q (Qb), veh	0	0	0	0	0	0	0	0	0	0	0	0
Ped-Bike Adj(A_pbT)	1.00		1.00	1.00		1.00	1.00		1.00	1.00		1.00
Parking Bus, Adj	1.00	1.00	1.00	1.00	1.00	1.00	1.00	1.00	1.00	1.00	1.00	1.00
Adj Sat Flow, veh/h/ln	1740	1690	1740	1740	1690	1740	1740	1740	1740	1740	1740	1740
Adj Flow Rate, veh/h	36	228	0	95	1139	0	827	0	0	23	66	0
Adj No. of Lanes	1	2	1	1	2	1	2	0	1	1	1	1
Peak Hour Factor	0.95	0.95	0.95	0.76	0.76	0.76	0.74	0.74	0.74	0.79	0.79	0.79
Percent Heavy Veh, %	2	5	2	2	5	2	2	2	2	2	2	2
Cap, veh/h	52	1579	727	658	1641	756	729	0	311	104	109	78
Arrive On Green	0.03	0.49	0.00	0.05	0.51	0.00	0.22	0.00	0.00	0.06	0.06	0.00
Sat Flow, veh/h	1657	3212	1479	1657	3212	1479	3315	0	1479	1657	1740	1479
Grp Volume(v), veh/h	36	228	0	95	1139	0	827	0	0	23	66	0
Grp Sat Flow(s),veh/h/ln	1657	1606	1479	1657	1606	1479	1657	0	1479	1657	1740	1479
Q Serve(g_s), s	2.2	3.9	0.0	2.9	26.9	0.0	22.0	0.0	0.0	1.3	3.7	0.0
Cycle Q Clear(g_c), s	2.2	3.9	0.0	2.9	26.9	0.0	22.0	0.0	0.0	1.3	3.7	0.0
Prop In Lane	1.00		1.00	1.00		1.00	1.00		1.00	1.00		1.00
Lane Grp Cap(c), veh/h	52	1579	727	658	1641	756	729	0	311	104	109	78
V/C Ratio(X)	0.69	0.14	0.00	0.14	0.69	0.00	1.13	0.00	0.00	0.22	0.60	0.00
Avail Cap(c_a), veh/h	108	1579	727	682	1641	756	729	0	311	232	244	192
HCM Platoon Ratio	1.00	1.00	1.00	1.00	1.00	1.00	1.00	1.00	1.00	1.00	1.00	1.00
Upstream Filter(I)	1.00	1.00	0.00	1.00	1.00	0.00	1.00	0.00	0.00	1.00	1.00	0.00
Uniform Delay (d), s/veh	48.0	13.9	0.0	11.9	18.5	0.0	39.0	0.0	0.0	44.5	45.6	0.0
Incr Delay (d2), s/veh	9.7	0.2	0.0	0.1	2.4	0.0	76.7	0.0	0.0	0.6	3.2	0.0
Initial Q Delay(d3),s/veh	0.0	0.0	0.0	0.0	0.0	0.0	0.0	0.0	0.0	0.0	0.0	0.0
%ile BackOfQ(50%),veh/ln	1.1	1.8	0.0	1.3	12.4	0.0	17.8	0.0	0.0	0.6	1.9	0.0
LnGrp Delay(d),s/veh	57.7	14.1	0.0	12.0	21.0	0.0	115.7	0.0	0.0	45.2	48.9	0.0
LnGrp LOS	E	B		B	C		F			D	D	
Approach Vol, veh/h		264			1234			827			89	
Approach Delay, s/veh		20.0			20.3			115.7			47.9	
Approach LOS		C			C			F			D	
Timer	1	2	3	4	5	6	7	8				
Assigned Phs	1	2		4	5	6		8				
Phs Duration (G+Y+Rc), s	8.6	55.1		10.3	10.5	53.2		26.0				
Change Period (Y+Rc), s	6.0	6.0		5.0	6.0	6.0		5.0				
Max Green Setting (Gmax), s	6.0	38.0		13.0	6.0	38.0		21.0				
Max Q Clear Time (g_c+I1), s	4.2	28.9		5.7	4.9	5.9		24.0				
Green Ext Time (p_c), s	0.0	8.3		0.1	0.0	26.1		0.0				
<b>Intersection Summary</b>												
HCM 2010 Ctrl Delay			54.0									
HCM 2010 LOS			D									
<b>Notes</b>												

Intersection												
Int Delay, s/veh	2.2											
Movement	EBL	EBT	EBR	WBL	WBT	WBR	NBL	NBT	NBR	SBL	SBT	SBR
Lane Configurations		↑	↗		↕		↖	↑	↗	↖	↑	↗
Traffic Vol, veh/h	37	4	10	3	4	59	17	471	2	17	240	20
Future Vol, veh/h	37	4	10	3	4	59	17	471	2	17	240	20
Conflicting Peds, #/hr	0	0	0	0	0	0	0	0	0	0	0	0
Sign Control	Stop	Stop	Stop	Stop	Stop	Stop	Free	Free	Free	Free	Free	Free
RT Channelized	-	-	Stop	-	-	None	-	-	None	-	-	None
Storage Length	-	-	170	-	-	-	140	-	280	540	-	430
Veh in Median Storage, #	-	0	-	-	0	-	-	0	-	-	0	-
Grade, %	-	0	-	-	0	-	-	0	-	-	0	-
Peak Hour Factor	81	81	81	81	81	81	81	81	81	81	81	81
Heavy Vehicles, %	2	2	2	2	2	2	2	2	2	2	2	2
Mvmt Flow	46	5	12	4	5	73	21	581	2	21	296	25

Major/Minor	Minor2		Minor1		Major1		Major2					
Conflicting Flow All	1000	961	296	964	961	581	296	0	0	581	0	0
Stage 1	338	338	-	623	623	-	-	-	-	-	-	-
Stage 2	662	623	-	341	338	-	-	-	-	-	-	-
Critical Hdwy	7.12	6.52	6.22	7.12	6.52	6.22	4.12	-	-	4.12	-	-
Critical Hdwy Stg 1	6.12	5.52	-	6.12	5.52	-	-	-	-	-	-	-
Critical Hdwy Stg 2	6.12	5.52	-	6.12	5.52	-	-	-	-	-	-	-
Follow-up Hdwy	3.518	4.018	3.318	3.518	4.018	3.318	2.218	-	-	2.218	-	-
Pot Cap-1 Maneuver	222	256	743	235	256	514	1265	-	-	993	-	-
Stage 1	676	641	-	474	478	-	-	-	-	-	-	-
Stage 2	451	478	-	674	641	-	-	-	-	-	-	-
Platoon blocked, %								-	-	-	-	-
Mov Cap-1 Maneuver	182	246	743	221	246	514	1265	-	-	993	-	-
Mov Cap-2 Maneuver	182	246	-	221	246	-	-	-	-	-	-	-
Stage 1	665	627	-	466	470	-	-	-	-	-	-	-
Stage 2	377	470	-	644	627	-	-	-	-	-	-	-

Approach	EB	WB	NB	SB
HCM Control Delay, s	12.8	14.6	0.3	0.5
HCM LOS	B	B		

Minor Lane/Major Mvmt	NBL	NBT	NBR	EBLn1	EBLn2	WBLn1	SBL	SBT	SBR
Capacity (veh/h)	1265	-	-	246	743	456	993	-	-
HCM Lane V/C Ratio	0.017	-	-	0.02	0.017	0.179	0.021	-	-
HCM Control Delay (s)	7.9	-	-	19.9	9.9	14.6	8.7	-	-
HCM Lane LOS	A	-	-	C	A	B	A	-	-
HCM 95th %tile Q(veh)	0.1	-	-	0.1	0.1	0.6	0.1	-	-

Intersection												
Int Delay, s/veh	2.2											
Movement	EBL	EBT	EBR	WBL	WBT	WBR	NBL	NBT	NBR	SBL	SBT	SBR
Lane Configurations		↑	↗		↕		↖	↑	↗	↖	↑	↗
Traffic Vol, veh/h	37	4	10	3	4	59	17	471	2	17	240	20
Future Vol, veh/h	37	4	10	3	4	59	17	471	2	17	240	20
Conflicting Peds, #/hr	0	0	0	0	0	0	0	0	0	0	0	0
Sign Control	Stop	Stop	Stop	Stop	Stop	Stop	Free	Free	Free	Free	Free	Free
RT Channelized	-	-	Stop	-	-	None	-	-	None	-	-	None
Storage Length	-	-	170	-	-	-	140	-	280	540	-	430
Veh in Median Storage, #	-	0	-	-	0	-	-	0	-	-	0	-
Grade, %	-	0	-	-	0	-	-	0	-	-	0	-
Peak Hour Factor	81	81	81	81	81	81	81	81	81	81	81	81
Heavy Vehicles, %	2	2	2	2	2	2	2	2	2	2	2	2
Mvmt Flow	46	5	12	4	5	73	21	581	2	21	296	25





























Major/Minor	Minor2		Minor1		Major1		Major2					
Conflicting Flow All	1000	961	296	964	961	581	296	0	0	581	0	0
Stage 1	338	338	-	623	623	-	-	-	-	-	-	-
Stage 2	662	623	-	341	338	-	-	-	-	-	-	-
Critical Hdwy	7.12	6.52	6.22	7.12	6.52	6.22	4.12	-	-	4.12	-	-
Critical Hdwy Stg 1	6.12	5.52	-	6.12	5.52	-	-	-	-	-	-	-
Critical Hdwy Stg 2	6.12	5.52	-	6.12	5.52	-	-	-	-	-	-	-
Follow-up Hdwy	3.518	4.018	3.318	3.518	4.018	3.318	2.218	-	-	2.218	-	-
Pot Cap-1 Maneuver	222	256	743	235	256	514	1265	-	-	993	-	-
Stage 1	676	641	-	474	478	-	-	-	-	-	-	-
Stage 2	451	478	-	674	641	-	-	-	-	-	-	-
Platoon blocked, %								-	-	-	-	-
Mov Cap-1 Maneuver	182	246	743	221	246	514	1265	-	-	993	-	-
Mov Cap-2 Maneuver	182	246	-	221	246	-	-	-	-	-	-	-
Stage 1	665	627	-	466	470	-	-	-	-	-	-	-
Stage 2	377	470	-	644	627	-	-	-	-	-	-	-

























Approach	EB	WB	NB	SB
HCM Control Delay, s	12.8	14.6	0.3	0.5
HCM LOS	B	B		

Minor Lane/Major Mvmt	NBL	NBT	NBR	EBLn1	EBLn2	WBLn1	SBL	SBT	SBR
Capacity (veh/h)	1265	-	-	246	743	456	993	-	-
HCM Lane V/C Ratio	0.017	-	-	0.02	0.017	0.179	0.021	-	-
HCM Control Delay (s)	7.9	-	-	19.9	9.9	14.6	8.7	-	-
HCM Lane LOS	A	-	-	C	A	B	A	-	-
HCM 95th %tile Q(veh)	0.1	-	-	0.1	0.1	0.6	0.1	-	-

HCM 2010 Signalized Intersection Summary  
4: Three Springs Road & US 160

Existing Winter PM (220 Closure)  
01/09/2019

												
Movement	EBL	EBT	EBR	WBL	WBT	WBR	NBL	NBT	NBR	SBL	SBT	SBR
Lane Configurations	 	 			 			 		 		
Traffic Volume (veh/h)	170	1199	6	16	646	57	11	9	16	173	7	360
Future Volume (veh/h)	170	1199	6	16	646	57	11	9	16	173	7	360
Number	1	6	16	5	2	12	3	8	18	7	4	14
Initial Q (Qb), veh	0	0	0	0	0	0	0	0	0	0	0	0
Ped-Bike Adj(A_pbT)	1.00		1.00	1.00		1.00	1.00		1.00	1.00		1.00
Parking Bus, Adj	1.00	1.00	1.00	1.00	1.00	1.00	1.00	1.00	1.00	1.00	1.00	1.00
Adj Sat Flow, veh/h/ln	1740	1707	1740	1740	1707	1740	1740	1740	1740	1740	1740	1740
Adj Flow Rate, veh/h	200	1411	0	17	680	0	20	16	0	211	9	0
Adj No. of Lanes	2	2	1	1	2	1	1	1	1	2	1	1
Peak Hour Factor	0.85	0.85	0.85	0.95	0.95	0.95	0.56	0.56	0.56	0.82	0.82	0.82
Percent Heavy Veh, %	2	4	2	2	4	2	2	2	2	2	2	2
Cap, veh/h	442	2283	1012	27	1891	833	166	67	42	363	87	59
Arrive On Green	0.14	0.70	0.00	0.02	0.58	0.00	0.06	0.04	0.00	0.07	0.05	0.00
Sat Flow, veh/h	3215	3243	1479	1657	3243	1479	1657	1740	1479	3215	1740	1479
Grp Volume(v), veh/h	200	1411	0	17	680	0	20	16	0	211	9	0
Grp Sat Flow(s),veh/h/ln	1608	1621	1479	1657	1621	1479	1657	1740	1479	1608	1740	1479
Q Serve(g_s), s	5.7	22.8	0.0	1.0	11.1	0.0	0.0	0.9	0.0	6.5	0.5	0.0
Cycle Q Clear(g_c), s	5.7	22.8	0.0	1.0	11.1	0.0	0.0	0.9	0.0	6.5	0.5	0.0
Prop In Lane	1.00		1.00	1.00		1.00	1.00		1.00	1.00		1.00
Lane Grp Cap(c), veh/h	442	2283	1012	27	1891	833	166	67	42	363	87	59
V/C Ratio(X)	0.45	0.62	0.00	0.63	0.36	0.00	0.12	0.24	0.00	0.58	0.10	0.00
Avail Cap(c_a), veh/h	442	2283	1012	96	1891	833	185	118	86	363	118	86
HCM Platoon Ratio	1.00	1.00	1.00	1.00	1.00	1.00	1.00	1.00	1.00	1.00	1.00	1.00
Upstream Filter(I)	1.00	1.00	0.00	1.00	1.00	0.00	1.00	1.00	0.00	1.00	1.00	0.00
Uniform Delay (d), s/veh	39.7	7.8	0.0	48.9	11.0	0.0	44.5	46.6	0.0	46.4	45.4	0.0
Incr Delay (d2), s/veh	0.4	1.3	0.0	13.6	0.5	0.0	0.2	1.1	0.0	1.9	0.3	0.0
Initial Q Delay(d3),s/veh	0.0	0.0	0.0	0.0	0.0	0.0	0.0	0.0	0.0	0.0	0.0	0.0
%ile BackOfQ(50%),veh/ln	2.6	10.4	0.0	0.6	5.1	0.0	0.5	0.5	0.0	3.0	0.2	0.0
LnGrp Delay(d),s/veh	40.1	9.0	0.0	62.5	11.5	0.0	44.7	47.8	0.0	48.3	45.7	0.0
LnGrp LOS	D	A		E	B		D	D		D	D	
Approach Vol, veh/h		1611			697			36			220	
Approach Delay, s/veh		12.9			12.8			46.1			48.2	
Approach LOS		B			B			D			D	
Timer	1	2	3	4	5	6	7	8				
Assigned Phs	1	2	3	4	5	6	7	8				
Phs Duration (G+Y+Rc), s	18.9	62.0	9.9	9.2	6.8	74.1	11.0	8.1				
Change Period (Y+Rc), s	5.7	5.7	* 5.2	* 5.2	5.7	5.7	* 5.2	* 5.2				
Max Green Setting (Gmax), s	10.3	56.3	* 5.8	* 5.8	5.3	61.3	* 5.8	* 5.8				
Max Q Clear Time (g_c+I1), s	7.7	13.1	2.0	2.5	3.0	24.8	8.5	2.9				
Green Ext Time (p_c), s	0.2	3.2	0.0	0.0	0.0	9.6	0.0	0.0				
<b>Intersection Summary</b>												
HCM 2010 Ctrl Delay			16.3									
HCM 2010 LOS			B									
<b>Notes</b>												

												
Movement	EBL	EBT	EBR	WBL	WBT	WBR	NBL	NBT	NBR	SBL	SBT	SBR
Lane Configurations												
Traffic Volume (veh/h)	192	788	423	36	272	30	330	60	55	45	46	71
Future Volume (veh/h)	192	788	423	36	272	30	330	60	55	45	46	71
Number	1	6	16	5	2	12	3	8	18	7	4	14
Initial Q (Qb), veh	0	0	0	0	0	0	0	0	0	0	0	0
Ped-Bike Adj(A_pbT)	1.00		1.00	1.00		1.00	1.00		1.00	1.00		1.00
Parking Bus, Adj	1.00	1.00	1.00	1.00	1.00	1.00	1.00	1.00	1.00	1.00	1.00	1.00
Adj Sat Flow, veh/h/ln	1740	1690	1740	1740	1690	1740	1740	1740	1740	1740	1740	1740
Adj Flow Rate, veh/h	204	838	0	42	320	0	415	0	0	51	52	0
Adj No. of Lanes	1	2	1	1	2	1	2	0	1	1	1	1
Peak Hour Factor	0.94	0.94	0.94	0.85	0.85	0.85	0.90	0.90	0.90	0.88	0.88	0.88
Percent Heavy Veh, %	2	5	2	2	5	2	2	2	2	2	2	2
Cap, veh/h	692	1839	847	60	1696	781	526	0	220	95	100	70
Arrive On Green	0.08	0.57	0.00	0.04	0.53	0.00	0.16	0.00	0.00	0.06	0.06	0.00
Sat Flow, veh/h	1657	3212	1479	1657	3212	1479	3315	0	1479	1657	1740	1479
Grp Volume(v), veh/h	204	838	0	42	320	0	415	0	0	51	52	0
Grp Sat Flow(s),veh/h/ln	1657	1606	1479	1657	1606	1479	1657	0	1479	1657	1740	1479
Q Serve(g_s), s	5.6	15.1	0.0	2.5	5.2	0.0	12.0	0.0	0.0	3.0	2.9	0.0
Cycle Q Clear(g_c), s	5.6	15.1	0.0	2.5	5.2	0.0	12.0	0.0	0.0	3.0	2.9	0.0
Prop In Lane	1.00		1.00	1.00		1.00	1.00		1.00	1.00		1.00
Lane Grp Cap(c), veh/h	692	1839	847	60	1696	781	526	0	220	95	100	70
V/C Ratio(X)	0.29	0.46	0.00	0.70	0.19	0.00	0.79	0.00	0.00	0.54	0.52	0.00
Avail Cap(c_a), veh/h	699	1839	847	141	1696	781	762	0	325	149	157	118
HCM Platoon Ratio	1.00	1.00	1.00	1.00	1.00	1.00	1.00	1.00	1.00	1.00	1.00	1.00
Upstream Filter(I)	1.00	1.00	0.00	1.00	1.00	0.00	1.00	0.00	0.00	1.00	1.00	0.00
Uniform Delay (d), s/veh	9.2	12.4	0.0	47.7	12.4	0.0	40.5	0.0	0.0	45.8	45.8	0.0
Incr Delay (d2), s/veh	0.1	0.8	0.0	8.8	0.2	0.0	2.6	0.0	0.0	2.8	2.5	0.0
Initial Q Delay(d3),s/veh	0.0	0.0	0.0	0.0	0.0	0.0	0.0	0.0	0.0	0.0	0.0	0.0
%ile BackOfQ(50%),veh/ln	2.5	6.8	0.0	1.3	2.4	0.0	5.7	0.0	0.0	1.4	1.5	0.0
LnGrp Delay(d),s/veh	9.4	13.2	0.0	56.4	12.6	0.0	43.1	0.0	0.0	48.7	48.3	0.0
LnGrp LOS	A	B		E	B		D			D	D	
Approach Vol, veh/h		1042			362			415			103	
Approach Delay, s/veh		12.4			17.7			43.1			48.5	
Approach LOS		B			B			D			D	
Timer	1	2	3	4	5	6	7	8				
Assigned Phs	1	2		4	5	6		8				
Phs Duration (G+Y+Rc), s	13.6	56.8		9.7	9.1	61.3		19.9				
Change Period (Y+Rc), s	6.0	6.0		5.0	6.0	6.0		5.0				
Max Green Setting (Gmax), s	8.0	40.0		8.0	8.0	40.0		22.0				
Max Q Clear Time (g_c+1), s	7.6	7.2		5.0	4.5	17.1		14.0				
Green Ext Time (p_c), s	0.0	22.4		0.0	0.0	17.1		0.8				
<b>Intersection Summary</b>												
HCM 2010 Ctrl Delay			22.0									
HCM 2010 LOS			C									
<b>Notes</b>												

Intersection												
Int Delay, s/veh	1.7											
Movement	EBL	EBT	EBR	WBL	WBT	WBR	NBL	NBT	NBR	SBL	SBT	SBR
Lane Configurations		↑	↗		↕		↖	↑	↗	↖	↑	↗
Traffic Vol, veh/h	18	2	37	4	4	24	17	331	4	33	354	31
Future Vol, veh/h	18	2	37	4	4	24	17	331	4	33	354	31
Conflicting Peds, #/hr	0	0	0	0	0	0	0	0	0	0	0	0
Sign Control	Stop	Stop	Stop	Stop	Stop	Stop	Free	Free	Free	Free	Free	Free
RT Channelized	-	-	Stop	-	-	None	-	-	None	-	-	None
Storage Length	-	-	170	-	-	-	140	-	280	540	-	430
Veh in Median Storage, #	-	0	-	-	0	-	-	0	-	-	0	-
Grade, %	-	0	-	-	0	-	-	0	-	-	0	-
Peak Hour Factor	94	94	94	94	94	94	94	94	94	94	94	94
Heavy Vehicles, %	2	2	2	2	2	2	2	2	2	2	2	2
Mvmt Flow	19	2	39	4	4	26	18	352	4	35	377	33

Major/Minor	Minor2		Minor1		Major1		Major2					
Conflicting Flow All	850	835	377	836	835	352	377	0	0	352	0	0
Stage 1	447	447	-	388	388	-	-	-	-	-	-	-
Stage 2	403	388	-	448	447	-	-	-	-	-	-	-
Critical Hdwy	7.12	6.52	6.22	7.12	6.52	6.22	4.12	-	-	4.12	-	-
Critical Hdwy Stg 1	6.12	5.52	-	6.12	5.52	-	-	-	-	-	-	-
Critical Hdwy Stg 2	6.12	5.52	-	6.12	5.52	-	-	-	-	-	-	-
Follow-up Hdwy	3.518	4.018	3.318	3.518	4.018	3.318	2.218	-	-	2.218	-	-
Pot Cap-1 Maneuver	280	304	670	287	304	692	1181	-	-	1207	-	-
Stage 1	591	573	-	636	609	-	-	-	-	-	-	-
Stage 2	624	609	-	590	573	-	-	-	-	-	-	-
Platoon blocked, %								-	-	-	-	-
Mov Cap-1 Maneuver	258	291	670	260	291	692	1181	-	-	1207	-	-
Mov Cap-2 Maneuver	258	291	-	260	291	-	-	-	-	-	-	-
Stage 1	582	556	-	626	600	-	-	-	-	-	-	-
Stage 2	588	600	-	537	556	-	-	-	-	-	-	-

Approach	EB		WB		NB		SB	
HCM Control Delay, s	11		12.7		0.4		0.6	
HCM LOS	B		B					

Minor Lane/Major Mvmt	NBL	NBT	NBR	EBLn1	EBLn2	WBLn1	SBL	SBT	SBR
Capacity (veh/h)	1181	-	-	291	670	501	1207	-	-
HCM Lane V/C Ratio	0.015	-	-	0.007	0.059	0.068	0.029	-	-
HCM Control Delay (s)	8.1	-	-	17.5	10.7	12.7	8.1	-	-
HCM Lane LOS	A	-	-	C	B	B	A	-	-
HCM 95th %tile Q(veh)	0	-	-	0	0.2	0.2	0.1	-	-